



Digital HD Video Camera Recorder
HDR-CX240/CX240E/PJ240/PJ240E/PJ270/PJ270E/PJ275
HANDYCAM



Use this Help Guide when you have any questions on how to use your product.



How to Use

Before use



Getting started



Recording



Playback



Saving images with an external device



Using the Wi-Fi function



Menu operations



Charging time/recording time of movies/number of recordable photos



Additional information



Troubleshooting

[Troubleshooting](#)



[Self-diagnosis display/Warning indicators](#)



[Warning messages](#)



[List of Topics](#)

[How to Use](#)



[Troubleshooting](#)



[Notes on use](#)

4-531-544-11(1)

Copyright 2014 Sony Corporation

Table Of Contents

| | |
|---|-----|
| Table of Contents..... | ii |
| How to Use..... | 13 |
| Before use..... | 1 |
| Model Information..... | 86 |
| Parts and controls..... | 24 |
| Parts and controls (front/top)..... | 88 |
| Parts and controls (LCD monitor)..... | 89 |
| Parts and controls (side)..... | 90 |
| Parts and controls (back/bottom)..... | 91 |
| Screen indicators..... | 93 |
| How to operate..... | 26 |
| Selecting items on the LCD monitor..... | 95 |
| Getting started..... | 2 |
| Supplied items..... | 96 |
| Power source preparations..... | 28 |
| Inserting the battery pack..... | 97 |
| Charging the battery pack using the AC Adaptor..... | 99 |
| Charging the battery pack using your computer..... | 101 |
| Turning the power on..... | 103 |
| Using this product supplying power from a wall outlet (wall socket)..... | 104 |
| Checking the remaining battery power..... | 105 |
| Initial setup..... | 29 |
| Setting the language, date and time..... | 106 |
| Adjusting the angle of the LCD monitor for easier viewing..... | 107 |
| Displaying items on the LCD monitor..... | 108 |
| Preparing a memory card..... | 30 |
| Inserting a memory card..... | 109 |
| Types of memory card you can use with this product..... | 111 |
| Recording..... | 3 |
| Recording movies/photos..... | 31 |
| Recording movies..... | 112 |
| Shooting photos..... | 114 |
| Useful functions for recording..... | 32 |
| Zooming..... | 116 |
| Capturing photos during movie recording (Dual Capture)..... | 117 |
| Recording in mirror mode..... | 118 |
| Intelligent Auto..... | 119 |

| | |
|--|-----|
| Playback..... | 4 |
| Playing images using Event View..... | 33 |
| Playing movies and photos from the Event View screen..... | 120 |
| Screen display on the Event View screen..... | 122 |
| Playing images using Highlight Playback..... | 34 |
| Playing back a short movie (Highlight Playback)..... | 124 |
| Changing the settings for Highlight Playback..... | 126 |
| Saving Highlight Playback (Scenario Save)..... | 127 |
| Playing back a saved scenario..... | 128 |
| Playing MP4 movies (HD movie) (switching the movie format)..... | 35 |
| Playing MP4 movies (HD movie)..... | 129 |
| Editing images from the playback screen..... | 36 |
| Notes on editing..... | 130 |
| Deleting the selected images..... | 131 |
| Deleting by date..... | 132 |
| Dividing a movie..... | 133 |
| Capturing a photo from a movie..... | 134 |
| Viewing trajectory of a moving object..... | 135 |
| Using the built-in projector..... | 37 |
| Notes on using the projector..... | 136 |
| Using the built-in projector..... | 137 |
| Using the projector for your computer or smartphone..... | 139 |
| Playing images on a high definition TV..... | 38 |
| Connecting this product to a high definition TV..... | 141 |
| Using BRAVIA Sync..... | 142 |
| On Photo TV HD..... | 143 |
| On the HDMI cable..... | 144 |
| Playing images on a non-high-definition TV..... | 39 |
| Connecting this product to a non-high-definition TV..... | 145 |
| Saving images with an external device..... | 5 |
| Using the PlayMemories Home software..... | 40 |
| Using the PlayMemories Home software..... | 146 |
| Checking the computer system..... | 147 |
| Installing the PlayMemories Home software in your computer..... | 148 |
| Disconnecting this product from the computer..... | 149 |
| About the dedicated software for this product..... | 150 |
| Creating a Blu-ray disc..... | 151 |
| Creating a disc with a recorder..... | 152 |
| Using the Wi-Fi function..... | 6 |

| | |
|---|-----|
| What you can do with the Wi-Fi function..... | 154 |
| Controlling via a smartphone..... | 43 |
| Using your smartphone or tablet as a wireless remote commander..... | 156 |
| Using your smartphone or tablet as a wireless remote commander using the NFC function..... | 158 |
| Transferring images to a smartphone..... | 44 |
| Transferring movies (MP4) and photos to your smartphone or tablet..... | 160 |
| Transferring movies (MP4) and photos to your smartphone or tablet using the NFC function..... | 162 |
| Transferring images to a computer..... | 45 |
| Send to Computer..... | 164 |
| Transferring images to a TV..... | 46 |
| Playing images on a TV..... | 165 |
| Connecting a smartphone..... | 47 |
| Connecting to an Android smartphone or tablet..... | 166 |
| Connecting to an iPhone or iPad..... | 168 |
| Connecting to an NFC-enabled smartphone or tablet..... | 170 |
| Installing PlayMemories Mobile..... | 48 |
| About the PlayMemories Mobile software..... | 172 |
| Menu operations..... | 7 |
| Using menu items..... | 49 |
| Setting up menu items..... | 173 |
| How to use the keyboard (HDR-PJ275)..... | 175 |
| Shooting Mode..... | 50 |
| Movie..... | 176 |
| Photo..... | 177 |
| Camera/Mic..... | 51 |
| White Balance..... | 178 |
| Exposure..... | 179 |
| Focus..... | 180 |
| Low Lux..... | 181 |
| Scene Selection..... | 182 |
| Picture Effect..... | 184 |
| Fader..... | 185 |
| Self-Timer..... | 186 |
| SteadyShot (Movie)..... | 187 |
| Digital Zoom..... | 188 |
| Auto Back Light..... | 189 |

| | |
|---|-----|
| Face Detection..... | 190 |
| Smile Shutter..... | 191 |
| Smile Sensitivity..... | 192 |
| Blt-in Zoom Mic..... | 193 |
| Wind Noise Reduct..... | 194 |
| Micref Level..... | 195 |
| Ctrl with Smartphone (HDR-PJ275)..... | 196 |
| My Button..... | 197 |
| Grid Line..... | 198 |
| Display Setting..... | 199 |
| Image Quality/Size..... | 53 |
| REC Mode..... | 200 |
| Frame Rate..... | 201 |
| Dual Video REC..... | 202 |
| Image Size..... | 203 |
| Playback Function..... | 54 |
| Event View..... | 204 |
| Scenario..... | 205 |
| Edit/Copy..... | 55 |
| Send to Smartphone (HDR-PJ275)..... | 206 |
| View on TV (HDR-PJ275)..... | 207 |
| Send to Computer (HDR-PJ275)..... | 208 |
| Delete..... | 209 |
| Protect..... | 210 |
| Copy..... | 211 |
| Setup..... | 56 |
| Media Select (HDR-PJ270/PJ270E/PJ275)..... | 212 |
| Media Info..... | 213 |
| Format..... | 214 |
| Empty (HDR-PJ270/PJ270E/PJ275)..... | 215 |
| Repair Img. DB F..... | 216 |
| File Number..... | 217 |
| Data Code..... | 218 |
| Volume..... | 220 |
| Motion Interval ADJ..... | 221 |
| Download Music (HDR-CX240/PJ240/PJ270/PJ275)..... | 222 |
| Empty Music (HDR-CX240/PJ240/PJ270/PJ275)..... | 223 |
| WPS Push (HDR-PJ275)..... | 224 |
| Access point settings (HDR-PJ275)..... | 225 |
| Edit Device Name (HDR-PJ275)..... | 227 |

| | |
|---|-----|
| Disp MAC Address (HDR-PJ275)..... | 228 |
| SSID/PW Reset (HDR-PJ275)..... | 229 |
| Network Info Reset (HDR-PJ275)..... | 230 |
| TV Type..... | 231 |
| HDMI Resolution..... | 232 |
| CTRL FOR HDMI..... | 233 |
| USB Connect..... | 234 |
| USB Connect Setting..... | 235 |
| USB Power Supply..... | 236 |
| USB LUN Setting..... | 237 |
| Beep..... | 238 |
| Monitor Brightness..... | 239 |
| Airplane Mode (HDR-PJ275)..... | 240 |
| Language Setting..... | 241 |
| Power Save..... | 242 |
| Initialize..... | 243 |
| Demo Mode..... | 244 |
| Date & Time Setting..... | 245 |
| Area Setting..... | 246 |
| Charging time/recording time of movies/number of recordable photos..... | 8 |
| Charging time..... | 247 |
| Expected recording and playback times for individual batteries..... | 60 |
| Expected recording time with NP-BX1..... | 248 |
| Expected playback time with NP-BX1..... | 249 |
| Expected movie recording time and number of recordable photos for the internal memory..... | 61 |
| Notes on recording movies..... | 250 |
| Expected recording time of movies..... | 251 |
| Expected number of recordable photos..... | 252 |
| Expected movie recording time and number of recordable photos for memory cards..... | 62 |
| Notes on recording movies..... | 250 |
| Expected recording time of movies..... | 253 |
| Expected number of recordable photos..... | 255 |
| Bit-rate for each recording mode..... | 63 |
| Bit-rate and recording pixels..... | 256 |
| Pixels recorded at each image size of photos..... | 64 |
| Recording pixels and aspect ratio..... | 257 |
| Additional information..... | 9 |
| Precautions..... | 65 |

| | |
|--|-----|
| About the AVCHD format..... | 258 |
| About the memory card..... | 259 |
| About the battery pack..... | 261 |
| Handling of this product..... | 66 |
| On use and care..... | 263 |
| On connecting to a computer or accessory etc..... | 266 |
| Notes on optional accessories..... | 267 |
| On moisture condensation..... | 268 |
| Notes on disposal/transfer the ownership of this product..... | 269 |
| Maintenance..... | 67 |
| On handling the LCD monitor..... | 270 |
| To clean the casing and the projector lens surface..... | 271 |
| About care and storage of the lens..... | 272 |
| Using this product abroad..... | 68 |
| Using this product abroad..... | 273 |
| World time difference..... | 275 |
| Trademarks..... | 69 |
| On trademarks..... | 277 |
| License..... | 70 |
| Notes on the License..... | 279 |
| Zoom magnifications..... | 280 |
| Troubleshooting..... | 19 |
| Troubleshooting..... | 10 |
| If you have problems..... | 281 |
| Overall operations..... | 73 |
| The power does not turn on..... | 282 |
| This product does not operate even when the power is set to on..... | 283 |
| The menu settings have been changed automatically..... | 284 |
| This product gets warm..... | 285 |
| A rattling noise is heard when this product is shaken..... | 286 |
| Intelligent Auto is canceled..... | 287 |
| Batteries/power sources..... | 74 |
| The power abruptly turns off..... | 288 |
| The POWER/CHG (charge) lamp does not light while the battery pack is being charged..... | 289 |
| The POWER/CHG (charge) lamp flashes while the battery pack is being charged..... | 290 |
| The remaining battery power is not displayed correctly..... | 291 |
| The battery pack is quickly discharged..... | 292 |

| | |
|--|-----|
| Monitor..... | 75 |
| Menu items are grayed out..... | 293 |
| The buttons do not appear on the LCD monitor..... | 294 |
| The buttons on the LCD monitor quickly disappear..... | 295 |
| There are dots in the shape of a grid on the monitor..... | 296 |
| The backlight of the LCD monitor turns off if you do not attempt to operate this product for a while..... | 297 |
| Memory card..... | 76 |
| Operations using the memory card cannot be performed..... | 298 |
| Images stored on the memory card cannot be deleted..... | 299 |
| The data file name is not indicated correctly or flashes..... | 300 |
| Images cannot be played back or the memory card is not recognized..... | 301 |
| Recording..... | 77 |
| Pressing START/STOP or PHOTO does not record images..... | 302 |
| Photos cannot be recorded..... | 303 |
| The access lamp remains lit or flashing even if recording has stopped..... | 304 |
| The imaging field looks different..... | 305 |
| The actual recording time for movies is less than the expected recording time of the recording media..... | 306 |
| This product stops recording..... | 307 |
| There is a slight time lag between the moment when START/STOP is pressed and the actual movie recording starts or stops..... | 308 |
| The auto focus does not function..... | 309 |
| SteadyShot does not function..... | 310 |
| Images cannot be recorded or played back correctly..... | 311 |
| The subjects passing across this product very fast appear crooked..... | 312 |
| Horizontal stripes appear on the images..... | 313 |
| [Monitor Brightness] cannot be set..... | 314 |
| Photos are recorded automatically..... | 315 |
| Playback..... | 78 |
| Images cannot be played back..... | 316 |
| Photos cannot be played back..... | 317 |
| The movie freezes..... | 318 |
| An icon appears on a thumbnail..... | 319 |
| No sound or only a quiet sound is heard during playback..... | 320 |
| Wi-Fi..... | 79 |

| | |
|---|-----|
| The wireless access point you want to connect to does not appear..... | 321 |
| [WPS Push] does not work..... | 322 |
| [Ctrl with Smartphone], [Send to Smartphone], [Send to Computer] or [View on TV] terminatesprematurely..... | 323 |
| Cannot transfer movies to your smartphone..... | 324 |
| The shooting screen does not display smoothly..... | 325 |
| The NFC connection does not work..... | 326 |
| Editing movies/photos on this product..... | 80 |
| Unable to edit..... | 327 |
| A movie cannot be divided..... | 328 |
| The demonstration movies cannot be deleted..... | 329 |
| Playback on a TV..... | 81 |
| Neither image nor sound is played on the connected TV..... | 330 |
| The top, bottom, right, and left edges of images are trimmed slightly on a connected TV..... | 331 |
| The image appears distorted on the 4:3 TV..... | 332 |
| Black bands appear at the top and bottom of the LCD monitor of the 4:3 TV..... | 333 |
| Copying/Connecting to other devices..... | 82 |
| Images are not copied correctly..... | 334 |
| Connecting to a computer..... | 83 |
| PlayMemories Home cannot be installed..... | 335 |
| PlayMemories Home does not work correctly..... | 336 |
| This product is not recognized by the computer..... | 337 |
| Self-diagnosis display..... | 338 |
| Warning Indicators..... | 340 |



Digital HD Video Camera Recorder
HDR-CX240/CX240E/PJ240/PJ240E/PJ270/PJ270E/PJ275

Before use

[Model Information](#)



[Parts and controls](#)



[Screen indicators](#)



[How to operate](#)



[Notes on use](#)

4-531-544-11(1)

Copyright 2014 Sony Corporation



Digital HD Video Camera Recorder
HDR-CX240/CX240E/PJ240/PJ240E/PJ270/PJ270E/PJ275

Getting started

[Checking the supplied items](#)



[Power source preparations](#)



[Initial setup](#)



[Preparing a memory card](#)



[Notes on use](#)

4-531-544-11(1)

Copyright 2014 Sony Corporation



Digital HD Video Camera Recorder
HDR-CX240/CX240E/PJ240/PJ240E/PJ270/PJ270E/PJ275

Recording

[Recording movies/photos](#)



[Useful functions for recording](#)



[Notes on use](#)

4-531-544-11(1)

Copyright 2014 Sony Corporation



Digital HD Video Camera Recorder
HDR-CX240/CX240E/PJ240/PJ240E/PJ270/PJ270E/PJ275

Playback

[Playing images using Event View](#)



[Playing images using Highlight Playback](#)



[Playing MP4 movies \(HD movie\) \(switching the movie format\)](#)



[Editing images from the playback screen](#)



[Using the built-in projector](#)



[Playing images on a high definition TV](#)



[Playing images on a non-high-definition TV](#)



[Notes on use](#)

4-531-544-11(1)

Copyright 2014 Sony Corporation



Digital HD Video Camera Recorder
HDR-CX240/CX240E/PJ240/PJ240E/PJ270/PJ270E/PJ275

Saving images with an external device

[Using the PlayMemories Home software](#)



[Creating a disc with a recorder](#)



[Notes on use](#)

4-531-544-11(1)

Copyright 2014 Sony Corporation



Digital HD Video Camera Recorder
HDR-CX240/CX240E/PJ240/PJ240E/PJ270/PJ270E/PJ275

Using the Wi-Fi function

[What you can do with the Wi-Fi function](#)



[Controlling via a smartphone](#)



[Transferring images to a smartphone](#)



[Transferring images to a computer](#)



[Transferring images to a TV](#)



[Connecting a smartphone](#)



[Installing PlayMemories Mobile](#)



Notes on use

4-531-544-11(1)

Copyright 2014 Sony Corporation



Digital HD Video Camera Recorder
HDR-CX240/CX240E/PJ240/PJ240E/PJ270/PJ270E/PJ275

Menu operations

[Using menu items](#)



[Shooting Mode](#)



[Camera/Mic](#)



[Image Quality/Size](#)



[Playback Function](#)



[Edit/Copy](#)



[Setup](#)



[Notes on use](#)

4-531-544-11(1)

Copyright 2014 Sony Corporation



Digital HD Video Camera Recorder
HDR-CX240/CX240E/PJ240/PJ240E/PJ270/PJ270E/PJ275

Charging time/recording time of movies/number of recordable photos

[Check the charging time](#)

[Expected recording and playback times for individual batteries](#)

[Expected movie recording time and number of recordable photos for the internal memory](#)

[Expected movie recording time and number of recordable photos for memory cards](#)

[Bit-rate for each recording mode](#)

[Pixels recorded at each image size of photos](#)

[Notes on use](#)

4-531-544-11(1)

Copyright 2014 Sony Corporation



Digital HD Video Camera Recorder
HDR-CX240/CX240E/PJ240/PJ240E/PJ270/PJ270E/PJ275

Additional information

[Precautions](#)



[Handling of this product](#)



[Maintenance](#)



[Using this product abroad](#)



[Trademarks](#)



[License](#)



[Zoom magnifications](#)



[Notes on use](#)

4-531-544-11(1)

Copyright 2014 Sony Corporation



Digital HD Video Camera Recorder
HDR-CX240/CX240E/PJ240/PJ240E/PJ270/PJ270E/PJ275

Troubleshooting

[If you have problems](#)



[Overall operations](#)



[Batteries/power sources](#)



[Monitor](#)



[Memory card](#)



[Recording](#)



[Playback](#)



[Wi-Fi](#)



[Editing movies/photos on this product](#)



[Playback on a TV](#)



[Copying/Connecting to other devices](#)



[Connecting to a computer](#)



[Notes on use](#)



Troubleshooting

Digital HD Video Camera Recorder
HDR-CX240/CX240E/PJ240/PJ240E/PJ270/PJ270E/PJ275

Self-diagnosis display/Warning indicators

[Self-diagnosis display/Warning indicators](#)



[Notes on use](#)

4-531-544-11(1)

Copyright 2014 Sony Corporation



Troubleshooting

Digital HD Video Camera Recorder
HDR-CX240/CX240E/PJ240/PJ240E/PJ270/PJ270E/PJ275

Warning messages

[Warning messages](#)



[Notes on use](#)

4-531-544-11(1)

Copyright 2014 Sony Corporation



Digital HD Video Camera Recorder
HDR-CX240/CX240E/PJ240/PJ240E/PJ270/PJ270E/PJ275

How to Use

Before use

Model Information

- [Model Information](#)

Parts and controls

- [Parts and controls \(front/top\)](#)
- [Parts and controls \(LCD monitor\)](#)
- [Parts and controls \(side\)](#)
- [Parts and controls \(back/bottom\)](#)

Screen indicators

- [Screen indicators](#)

How to operate

- [Selecting items on the LCD monitor](#)

Getting started

Checking the supplied items

- [Supplied items](#)

Power source preparations

- [Inserting the battery pack](#)
- [Charging the battery pack using the AC Adaptor](#)
- [Charging the battery pack using your computer](#)
- [Turning the power on](#)
- [Using this product supplying power from a wall outlet \(wall socket\)](#)
- [Checking the remaining battery power](#)

Initial setup

- [Setting the language, date and time](#)
- [Adjusting the angle of the LCD monitor for easier viewing](#)
- [Displaying items on the LCD monitor](#)

Preparing a memory card

- [Inserting a memory card](#)
- [Types of memory card you can use with this product](#)

Recording

Recording movies/photos

Recording movies

- Shooting photos

Useful functions for recording

- Zooming
- Capturing photos during movie recording (Dual Capture)
- Recording in mirror mode
- Intelligent Auto

Playback

Playing images using Event View

- Playing movies and photos from the Event View screen
- Screen display on the Event View screen

Playing images using Highlight Playback

- Playing back a short movie (Highlight Playback)
- Changing the settings for Highlight Playback
- Saving Highlight Playback (Scenario Save)
- Playing back a saved scenario

Playing MP4 movies (HD movie) (switching the movie format)

- Playing MP4 movies (HD movie) (switching the movie format)

Editing images from the playback screen

- Notes on editing
- Deleting the selected images
- Deleting by date
- Dividing a movie
- Capturing a photo from a movie (models with the internal memory or models with the USB IN/OUT jacks)
- Viewing trajectory of a moving object (Motion Shot Video)

Using the built-in projector

- Notes on using the projector (models with the projector)
- Using the built-in projector (models with the projector)
- Using the projector for your computer or smartphone (models with the projector)

Playing images on a high definition TV

- Connecting this product to a high definition TV
- Using BRAVIA Sync
- On Photo TV HD
- On the HDMI cable

Playing images on a non-high-definition TV

- Connecting this product to a non-high-definition TV

Saving images with an external device

Using the PlayMemories Home software

- Using the PlayMemories Home software
- Checking the computer system
- Installing the PlayMemories Home software in your computer
- Disconnecting this product from the computer

- [About the dedicated software for this product](#)
- [Creating a Blu-ray disc](#)

Creating a disc with a recorder

- [Creating a disc with a recorder](#)

Using the Wi-Fi function

What you can do with the Wi-Fi function

- [What you can do with the Wi-Fi function \(models with the Wi-Fi/NFC functions\)](#)

Controlling via a smartphone

- [Using your smartphone or tablet as a wireless remote commander \(models with the Wi-Fi/NFC functions\)](#)
- [Using your smartphone or tablet as a wireless remote commander using the NFC function \(NFC one-touch remote\) \(models with the Wi-Fi/NFC functions\)](#)

Transferring images to a smartphone

- [Transferring movies \(MP4\) and photos to your smartphone or tablet \(models with the Wi-Fi/NFC functions\)](#)
- [Transferring movies \(MP4\) and photos to your smartphone or tablet using the NFC function \(NFC one-touch sharing\) \(models with the Wi-Fi/NFC functions\)](#)

Transferring images to a computer

- [Send to Computer \(models with the Wi-Fi/NFC functions\)](#)

Transferring images to a TV

- [Playing images on a TV \(View on TV\) \(models with the Wi-Fi/NFC functions\)](#)

Connecting a smartphone

- [Connecting to an Android smartphone or tablet \(models with the Wi-Fi/NFC functions\)](#)
- [Connecting to an iPhone or iPad \(models with the Wi-Fi/NFC functions\)](#)
- [Connecting to an NFC-enabled smartphone or tablet \(models with the Wi-Fi/NFC functions\)](#)

Installing PlayMemories Mobile

- [About the PlayMemories Mobile software \(models with the Wi-Fi/NFC functions\)](#)

Menu operations

Using menu items

- [Setting up menu items](#)
- [How to use the keyboard \(HDR-PJ275\)](#)

Shooting Mode

- [Movie](#)
- [Photo](#)

Camera/Mic

- [White Balance](#)
- [Exposure](#)
- [Focus](#)
- [Low Lux](#)
- [Scene Selection](#)
- [Picture Effect](#)
- [Fader](#)
- [Self-Timer](#)

- SteadyShot (Movie)
- Digital Zoom
- Auto Back Light
- Face Detection
- Smile Shutter
- Smile Sensitivity
- Blt-in Zoom Mic
- Wind Noise Reduct.
- Micref Level
- Ctrl with Smartphone (HDR-PJ275)
- My Button
- Grid Line
- Display Setting

Image Quality/Size

- REC Mode
- Frame Rate
- Dual Video REC
- Image Size

Playback Function

- Event View
- Scenario

Edit/Copy

- Send to Smartphone (HDR-PJ275)
- View on TV (HDR-PJ275)
- Send to Computer (HDR-PJ275)
- Delete
- Protect
- Copy

Setup

- Media Select (HDR-PJ270/PJ270E/PJ275)
- Media Info
- Format
- Empty (HDR-PJ270/PJ270E/PJ275)
- Repair Img. DB F.
- File Number
- Data Code
- Volume
- Motion Interval ADJ
- Download Music (HDR-CX240/PJ240/PJ270/PJ275)
- Empty Music (HDR-CX240/PJ240/PJ270/PJ275)
- WPS Push (HDR-PJ275)
- Access point settings (HDR-PJ275)
- Edit Device Name (HDR-PJ275)
- Disp MAC Address (HDR-PJ275)

- [SSID/PW Reset \(HDR-PJ275\)](#)
- [Network Info Reset \(HDR-PJ275\)](#)
- [TV Type](#)
- [HDMI Resolution](#)
- [CTRL FOR HDMI](#)
- [USB Connect](#)
- [USB Connect Setting](#)
- [USB Power Supply](#)
- [USB LUN Setting](#)
- [Beep](#)
- [Monitor Brightness](#)
- [Airplane Mode \(HDR-PJ275\)](#)
- [Language Setting](#)
- [Power Save](#)
- [Initialize](#)
- [Demo Mode](#)
- [Date & Time Setting](#)
- [Area Setting](#)

Charging time/recording time of movies/number of recordable photos

Check the charging time

- [Charging time](#)

Expected recording and playback times for individual batteries

- [Expected recording time with NP-BX1](#)
- [Expected playback time with NP-BX1](#)

Expected movie recording time and number of recordable photos for the internal memory

- [Notes on recording movies](#)
- [Expected recording time of movies](#)
- [Expected number of recordable photos](#)

Expected movie recording time and number of recordable photos for memory cards

- [Notes on recording movies](#)
- [Expected recording time of movies](#)
- [Expected number of recordable photos](#)

Bit-rate for each recording mode

- [Bit-rate and recording pixels](#)

Pixels recorded at each image size of photos

- [Recording pixels and aspect ratio](#)

Additional information

Precautions

- [About the AVCHD format](#)
- [About the memory card](#)
- [About the battery pack](#)

Handling of this product

- [On use and care](#)
- [On connecting to a computer or accessory etc.](#)
- [Notes on optional accessories](#)
- [On moisture condensation](#)
- [Notes on disposal/transfer the ownership of this product \(models equipped with the internal memory\)](#)

Maintenance

- [On handling the LCD monitor](#)
- [To clean the casing and the projector lens surface \(models with the projector\)](#)
- [About care and storage of the lens](#)

Using this product abroad

- [Using this product abroad](#)
- [World time difference](#)

Trademarks

- [On trademarks](#)

License

- [Notes on the License](#)

Zoom magnifications

- [Zoom magnifications](#)

[Notes on use](#)

4-531-544-11(1)

Copyright 2014 Sony Corporation



Digital HD Video Camera Recorder
HDR-CX240/CX240E/PJ240/PJ240E/PJ270/PJ270E/PJ275

Troubleshooting

Troubleshooting

If you have problems

- [If you have problems](#)

Overall operations

- [The power does not turn on.](#)
- [This product does not operate even when the power is set to on.](#)
- [The menu settings have been changed automatically.](#)
- [This product gets warm.](#)
- [A rattling noise is heard when this product is shaken.](#)
- [Intelligent Auto is canceled.](#)

Batteries/power sources

- [The power abruptly turns off.](#)
- [The POWER/CHG \(charge\) lamp does not light while the battery pack is being charged.](#)
- [The POWER/CHG \(charge\) lamp flashes while the battery pack is being charged.](#)
- [The remaining battery power is not displayed correctly.](#)
- [The battery pack is quickly discharged.](#)

Monitor

- [Menu items are grayed out.](#)
- [The buttons do not appear on the LCD monitor.](#)
- [The buttons on the LCD monitor quickly disappear.](#)
- [There are dots in the shape of a grid on the monitor.](#)
- [The backlight of the LCD monitor turns off if you do not attempt to operate this product for a while.](#)

Memory card

- [Operations using the memory card cannot be performed.](#)
- [Images stored on the memory card cannot be deleted.](#)
- [The data file name is not indicated correctly or flashes.](#)
- [Images cannot be played back or the memory card is not recognized.](#)

Recording

- [Pressing START/STOP or PHOTO does not record images.](#)
- [Photos cannot be recorded.](#)
- [The access lamp remains lit or flashing even if recording has stopped.](#)
- [The imaging field looks different.](#)
- [The actual recording time for movies is less than the expected recording time of the recording media.](#)
- [This product stops recording.](#)

- There is a slight time lag between the moment when START/STOP is pressed and the actual movie recording starts or stops.
- The auto focus does not function.
- SteadyShot does not function.
- Images cannot be recorded or played back correctly.
- The subjects passing across this product very fast appear crooked.
- Horizontal stripes appear on the images.
- [Monitor Brightness] cannot be set.
- Photos are recorded automatically.

Playback

- Images cannot be played back.
- Photos cannot be played back.
- The movie freezes.
- An icon appears on a thumbnail.
- No sound or only a quiet sound is heard during playback.

Wi-Fi

- The wireless access point you want to connect to does not appear. (models with the Wi-Fi/NFC functions)
- [WPS Push] does not work. (models with the Wi-Fi/NFC functions)
- [Ctrl with Smartphone], [Send to Smartphone], [Send to Computer] or [View on TV] terminates prematurely. (models with the Wi-Fi/NFC functions)
- Cannot transfer movies to your smartphone. (models with the Wi-Fi/NFC functions)
- The shooting screen does not display smoothly. The connection is cut off. (models with the Wi-Fi/NFC functions)
- The NFC connection does not work. (models with the Wi-Fi/NFC functions)

Editing movies/photos on this product

- Unable to edit.
- A movie cannot be divided.
- The demonstration movies cannot be deleted. (models with the internal memory)

Playback on a TV

- Neither image nor sound is played on the connected TV.
- The top, bottom, right, and left edges of images are trimmed slightly on a connected TV.
- The image appears distorted on the 4:3 TV.
- Black bands appear at the top and bottom of the LCD monitor of the 4:3 TV.

Copying/Connecting to other devices

- Images are not copied correctly.

Connecting to a computer

- PlayMemories Home cannot be installed.
- PlayMemories Home does not work correctly.
- This product is not recognized by the computer.

Self-diagnosis display/Warning indicators

Self-diagnosis display/Warning indicators

- Self-diagnosis display

Warning messages

Warning messages

- [Warning Indicators](#)

Notes on use

4-531-544-11(1)

Copyright 2014 Sony Corporation



Digital HD Video Camera Recorder
HDR-CX240/CX240E/PJ240/PJ240E/PJ270/PJ270E/PJ275

Notes on use

Before use

To make full use of this content, please read the following notes thoroughly. Please note that they are subject to change without prior notice.

June 2013

Recommended system environment

The following system environments are recommended for displaying this content. You may not be able to view the content on other system environments.

- **For viewing on a computer**

Recommended browser

- _With Microsoft Windows
 - _Microsoft Internet Explorer 8 or later
 - _Mozilla Firefox: latest version
 - _Google Chrome™ : latest version
- _With Apple Mac OS
 - _Apple Safari Ver. 5 or later
 - _Mozilla Firefox: latest version
 - _Google Chrome : latest version

- **For viewing on a smartphone or tablet**

Basic operation has been confirmed on the standard browser for the noted devices running the following operating systems.

- _Android™ 2.3 or later: Xperia series, Walkman running Android
- _iOS 4 or later: iPhone, iPod touch, iPad

- **JavaScript**

JavaScript is used with this content for viewing convenience. If JavaScript is disabled in your web browser settings, the content may not operate properly or it may not be displayed correctly.

- **Style Sheets**

Cascading Style Sheets are used in designing this content. Page layout may not be as intended if you view the content with style sheets disabled or on a web browser that is not compatible with style sheets. However, operation will not be affected.

- **Cookies**

This content uses cookies. To use services incorporating cookies, you need to set your browser to allow cookies.

Handling of personal information obtained from websites

Sony may use cookies, web beacons or similar technologies to make statistical analysis of customers' usage of this content while preserving anonymity.



Digital HD Video Camera Recorder
HDR-CX240/CX240E/PJ240/PJ240E/PJ270/PJ270E/PJ275

Model Information

[Model Information](#)

Explains how to confirm the model name of this product and differences between each model.



[Notes on use](#)

4-531-544-11(1)

Copyright 2014 Sony Corporation



Digital HD Video Camera Recorder
HDR-CX240/CX240E/PJ240/PJ240E/PJ270/PJ270E/PJ275

Parts and controls

[Parts and controls \(front/top\)](#)

Explains the parts and controls on the front and top sides of this product.

[Parts and controls \(LCD monitor\)](#)

Explains the parts and controls on the LCD monitor.

[Parts and controls \(side\)](#)

Explains the parts and controls on the side of this product.

[Parts and controls \(back/bottom\)](#)

Explains the parts and controls on the back and bottom sides of this product.

[Notes on use](#)

4-531-544-11(1)

Copyright 2014 Sony Corporation



Digital HD Video Camera Recorder
HDR-CX240/CX240E/PJ240/PJ240E/PJ270/PJ270E/PJ275

Screen indicators

Screen indicators

Explains the icons displayed at times such as when changing the settings.



Notes on use

4-531-544-11(1)

Copyright 2014 Sony Corporation



Digital HD Video Camera Recorder
HDR-CX240/CX240E/PJ240/PJ240E/PJ270/PJ270E/PJ275

How to operate

Selecting items on the LCD monitor

Use the multi-selector to select the items on the LCD monitor.



Notes on use

4-531-544-11(1)

Copyright 2014 Sony Corporation



Digital HD Video Camera Recorder
HDR-CX240/CX240E/PJ240/PJ240E/PJ270/PJ270E/PJ275

Checking the supplied items

Supplied items

Check the supplied accessories.



Notes on use

4-531-544-11(1)

Copyright 2014 Sony Corporation



Digital HD Video Camera Recorder
HDR-CX240/CX240E/PJ240/PJ240E/PJ270/PJ270E/PJ275

Power source preparations

[Inserting the battery pack](#)

Insert the battery pack to this product.

[Charging the battery pack using the AC Adaptor](#)

Charge the battery pack using the supplied AC Adaptor.

[Charging the battery pack using your computer](#)

Charge the battery pack by connecting this product to your computer with the Built-in USB Cable.

[Turning the power on](#)

Turn on this product.

[Using this product supplying power from a wall outlet \(wall socket\)](#)

Shows how to use this product while supplying power from a wall outlet (wall socket).

[Checking the remaining battery power](#)

Explains the indicator which indicates the remaining battery power.

Notes on use

4-531-544-11(1)

Copyright 2014 Sony Corporation



Digital HD Video Camera Recorder
HDR-CX240/CX240E/PJ240/PJ240E/PJ270/PJ270E/PJ275

Initial setup

[Setting the language, date and time](#)

Set the language, date and time when using this product for the first time.



[Adjusting the angle of the LCD monitor for easier viewing](#)

You can adjust the angle of the LCD monitor for easier viewing.



[Displaying items on the LCD monitor](#)

Shows how to set the screen display.



Notes on use

4-531-544-11(1)

Copyright 2014 Sony Corporation



Digital HD Video Camera Recorder
HDR-CX240/CX240E/PJ240/PJ240E/PJ270/PJ270E/PJ275

Preparing a memory card

[Inserting a memory card](#)

Shows how to insert a memory card.



[Types of memory card you can use with this product](#)

Introduces types of memory card you can use with this product.



Notes on use

4-531-544-11(1)

Copyright 2014 Sony Corporation



Digital HD Video Camera Recorder
HDR-CX240/CX240E/PJ240/PJ240E/PJ270/PJ270E/PJ275

Recording movies/photos

[Recording movies](#)

Record movies.



[Shooting photos](#)

Shoot photos.



[Notes on use](#)

4-531-544-11(1)

Copyright 2014 Sony Corporation



Digital HD Video Camera Recorder
HDR-CX240/CX240E/PJ240/PJ240E/PJ270/PJ270E/PJ275

Useful functions for recording

[Zooming](#)

You can record an image with the subject magnified.

[Capturing photos during movie recording \(Dual Capture\)](#)

You can shoot photos during movie recording.

[Recording in mirror mode](#)

You can rotate the LCD monitor 180 degrees so the LCD monitor faces toward you to record yourself.

[Intelligent Auto](#)

This product records images after selecting the most suitable setting for the subjects or the situation automatically.

Notes on use

4-531-544-11(1)

Copyright 2014 Sony Corporation



Digital HD Video Camera Recorder
HDR-CX240/CX240E/PJ240/PJ240E/PJ270/PJ270E/PJ275

Playing images using Event View

[Playing movies and photos from the Event View screen](#)

You can search for recorded images by date and recording time (Event View).



[Screen display on the Event View screen](#)

Explains the Event View screen.



Notes on use

4-531-544-11(1)

Copyright 2014 Sony Corporation



Digital HD Video Camera Recorder
HDR-CX240/CX240E/PJ240/PJ240E/PJ270/PJ270E/PJ275

Playing images using Highlight Playback

[Playing back a short movie \(Highlight Playback\)](#)

You can enjoy a digest of movies and photos, similar to a short movie.



[Changing the settings for Highlight Playback](#)

You can set the playback range of the Highlight Playback and select a theme for Highlight Playback.



[Saving Highlight Playback \(Scenario Save\)](#)

You can save your favorite Highlight Playback as a "Scenario." Up to 8 scenarios can be saved.



[Playing back a saved scenario](#)

You can play back Highlight Scenarios saved on this product.



Notes on use

4-531-544-11(1)

Copyright 2014 Sony Corporation



Digital HD Video Camera Recorder
HDR-CX240/CX240E/PJ240/PJ240E/PJ270/PJ270E/PJ275

Playing MP4 movies (HD movie) (switching the movie format)

[Playing MP4 movies \(HD movie\) \(switching the movie format\)](#)

The format of a movie to be played or edited can be changed on the Event View screen.



[Notes on use](#)

4-531-544-11(1)

Copyright 2014 Sony Corporation



Digital HD Video Camera Recorder
HDR-CX240/CX240E/PJ240/PJ240E/PJ270/PJ270E/PJ275

Editing images from the playback screen

[Notes on editing](#)

Read the precautions regarding editing images.



[Deleting the selected images](#)

Select and delete unnecessary images.



[Deleting by date](#)

Select unnecessary images by date of recording and delete them.



[Dividing a movie](#)

Split a recorded movie at your desired point.



[Capturing a photo from a movie \(models with the internal memory or models with the USB IN/OUT jacks\)](#)

You can capture images from movies recorded with this product.



[Viewing trajectory of a moving object \(Motion Shot Video\)](#)

You can view the trajectory of a fast-moving object.



Notes on use

4-531-544-11(1)

Copyright 2014 Sony Corporation



Digital HD Video Camera Recorder
HDR-CX240/CX240E/PJ240/PJ240E/PJ270/PJ270E/PJ275

Using the built-in projector

[Notes on using the projector \(models with the projector\)](#)

Read the precautions regarding using the projector.

[Using the built-in projector \(models with the projector\)](#)

You can use a flat surface such as a wall as a screen to view recorded images using the built-in projector.

[Using the projector for your computer or smartphone \(models with the projector\)](#)

You can project images from a computer or smartphone using the built-in projector.

Notes on use

4-531-544-11(1)

Copyright 2014 Sony Corporation



Digital HD Video Camera Recorder
HDR-CX240/CX240E/PJ240/PJ240E/PJ270/PJ270E/PJ275

Playing images on a high definition TV

[Connecting this product to a high definition TV](#)

You can play movies in high definition image quality (HD) by connecting this product to an HDMI compatible TV. 

[Using BRAVIA Sync](#)

You can operate this product with the remote commander of your TV by connecting this product to a BRAVIA Sync compatible TV launched in 2008 or later with the HDMI cable. 

[On Photo TV HD](#)

Explains Photo TV HD. 

[On the HDMI cable](#)

Read the precautions regarding the HDMI cable. 

Notes on use

4-531-544-11(1)

Copyright 2014 Sony Corporation



Digital HD Video Camera Recorder
HDR-CX240/CX240E/PJ240/PJ240E/PJ270/PJ270E/PJ275

Playing images on a non-high-definition TV

[Connecting this product to a non-high-definition TV](#)

Play back images with this product connected to a TV by an AV cable (sold separately).



[Notes on use](#)

4-531-544-11(1)

Copyright 2014 Sony Corporation



Digital HD Video Camera Recorder
HDR-CX240/CX240E/PJ240/PJ240E/PJ270/PJ270E/PJ275

Using the PlayMemories Home software

[Using the PlayMemories Home software](#)

The PlayMemories Home software allows you to import movies and still images to your computer to use them in a variety of ways. 

[Checking the computer system](#)

Check the recommended computer environment for using software. 

[Installing the PlayMemories Home software in your computer](#)

Installing the PlayMemories Home software on your computer enables you to make use of your recorded images. 

[Disconnecting this product from the computer](#)

Disconnect this product from the computer connected with the Built-in USB Cable. 

[About the dedicated software for this product](#)

You can download the dedicated software from the Sony website. 

[Creating a Blu-ray disc](#)

You can create a Blu-ray disc with an AVCHD movie previously imported to a computer. 

Notes on use

4-531-544-11(1)

Copyright 2014 Sony Corporation



Digital HD Video Camera Recorder
HDR-CX240/CX240E/PJ240/PJ240E/PJ270/PJ270E/PJ275

Creating a disc with a recorder

[Creating a disc with a recorder](#)

You can copy images played back on this product on a disc or video cassette.



[Notes on use](#)

4-531-544-11(1)

Copyright 2014 Sony Corporation



Digital HD Video Camera Recorder
HDR-CX240/CX240E/PJ240/PJ240E/PJ270/PJ270E/PJ275

What you can do with the Wi-Fi function

[What you can do with the Wi-Fi function \(models with the Wi-Fi/NFC functions\)](#)

Explains what you can do using the Wi-Fi function of this product.



[Notes on use](#)

4-531-544-11(1)

Copyright 2014 Sony Corporation



Digital HD Video Camera Recorder
HDR-CX240/CX240E/PJ240/PJ240E/PJ270/PJ270E/PJ275

Controlling via a smartphone

[Using your smartphone or tablet as a wireless remote commander \(models with the Wi-Fi/NFC functions\)](#)



You can operate this product using your smartphone or tablet as a wireless remote commander.

[Using your smartphone or tablet as a wireless remote commander using the NFC function \(NFC one-touch remote\) \(models with the Wi-Fi/NFC functions\)](#)



You can operate this product using your NFC-enabled smartphone or tablet as a wireless remote commander.

Notes on use

4-531-544-11(1)

Copyright 2014 Sony Corporation



Digital HD Video Camera Recorder
HDR-CX240/CX240E/PJ240/PJ240E/PJ270/PJ270E/PJ275

Transferring images to a smartphone

[Transferring movies \(MP4\) and photos to your smartphone or tablet \(models with the Wi-Fi/NFC functions\)](#) 

Transfer images to your smartphone or tablet.

[Transferring movies \(MP4\) and photos to your smartphone or tablet using the NFC function \(NFC one-touch sharing\) \(models with the Wi-Fi/NFC functions\)](#) 

Transfer images to your NFC-enabled Android smartphone or tablet.

Notes on use

4-531-544-11(1)

Copyright 2014 Sony Corporation



Digital HD Video Camera Recorder
HDR-CX240/CX240E/PJ240/PJ240E/PJ270/PJ270E/PJ275

Transferring images to a computer

[Send to Computer \(models with the Wi-Fi/NFC functions\)](#)

You can transfer and save movies and photos to your computer.



[Notes on use](#)

4-531-544-11(1)

Copyright 2014 Sony Corporation



Digital HD Video Camera Recorder
HDR-CX240/CX240E/PJ240/PJ240E/PJ270/PJ270E/PJ275

Transferring images to a TV

[Playing images on a TV \(View on TV\) \(models with the Wi-Fi/NFC functions\)](#)

You can view images on your TV connected to the network by transferring images from this product without connecting this product and TV with a cable.



[Notes on use](#)

4-531-544-11(1)

Copyright 2014 Sony Corporation



Digital HD Video Camera Recorder
HDR-CX240/CX240E/PJ240/PJ240E/PJ270/PJ270E/PJ275

Connecting a smartphone

[Connecting to an Android smartphone or tablet \(models with the Wi-Fi/NFC functions\)](#)

Shows how to connect this product to your Android smartphone or tablet.

[Connecting to an iPhone or iPad \(models with the Wi-Fi/NFC functions\)](#)

Shows how to connect this product to your iPhone or iPad.

[Connecting to an NFC-enabled smartphone or tablet \(models with the Wi-Fi/NFC functions\)](#)

You can easily connect this product to your NFC-enabled Android smartphone or tablet.

Notes on use

4-531-544-11(1)

Copyright 2014 Sony Corporation



Digital HD Video Camera Recorder
HDR-CX240/CX240E/PJ240/PJ240E/PJ270/PJ270E/PJ275

Installing PlayMemories Mobile

[About the PlayMemories Mobile software \(models with the Wi-Fi/NFC functions\)](#)

Explains PlayMemories Mobile.



Notes on use

4-531-544-11(1)

Copyright 2014 Sony Corporation



Digital HD Video Camera Recorder
HDR-CX240/CX240E/PJ240/PJ240E/PJ270/PJ270E/PJ275

Using menu items

[Setting up menu items](#)

Shows how to set the menu items.



[How to use the keyboard \(HDR-PJ275\)](#)

Explains how to use the keyboard to be displayed.



Notes on use

4-531-544-11(1)

Copyright 2014 Sony Corporation



Digital HD Video Camera Recorder
HDR-CX240/CX240E/PJ240/PJ240E/PJ270/PJ270E/PJ275

Shooting Mode

Movie

You can select the movie recording mode.



Photo

You can select the photo shooting mode.



Notes on use

4-531-544-11(1)

Copyright 2014 Sony Corporation



Digital HD Video Camera Recorder
HDR-CX240/CX240E/PJ240/PJ240E/PJ270/PJ270E/PJ275

Camera/Mic

White Balance

You can adjust the color balance to the recording environment.

Exposure

You can fix the brightness of an image manually.

Focus

You can adjust the focus manually.

Low Lux

You can record bright color images, even in dim light.

Scene Selection

You can record images effectively in various situations.

Picture Effect

You can select your desired effect to shoot more impressive images.

Fader

You can record a transition with the effects adding to the interval between scenes.

Self-Timer

Press PHOTO to start the count down. A photo is recorded after about 10 seconds.

SteadyShot (Movie)

You can compensate for camera shake.

Digital Zoom

You can select the maximum zoom level.

Auto Back Light

This product adjusts the exposure for backlit subjects automatically.

Face Detection

You can set this product to detect a face automatically.

Smile Shutter

The shutter is released automatically when this product detects a smile.

Smile Sensitivity

Sets the smile detection sensitivity for using the Smile Shutter function.

Blt-in Zoom Mic

You can record a movie with vivid sound appropriate to the zoom position.

Wind Noise Reduct.

This product records a movie with less wind noise input from the built-in microphone.

Micref Level

You can select the microphone level for recording sound.

Ctrl with Smartphone (HDR-PJ275)

You can use your smartphone as a wireless remote commander.

My Button

You can assign functions that you frequently use when recording to one of the My Buttons.

Grid Line

You can display the lines and check that the subject is horizontal or vertical.

Display Setting

You can set the duration of displaying the icons or indicators on the LCD monitor while recording.

Notes on use

4-531-544-11(1)

Copyright 2014 Sony Corporation



Digital HD Video Camera Recorder
HDR-CX240/CX240E/PJ240/PJ240E/PJ270/PJ270E/PJ275

Image Quality/Size

REC Mode

You can select your desired image quality for AVCHD movies.



Frame Rate

You can select the frame rate to be used to record AVCHD movies.



Dual Video REC

You can set the dual recording mode (recording an MP4 movie during movie recording) to on or off.



Image Size

You can select a size for the photos you are going to shoot.



Notes on use

4-531-544-11(1)

Copyright 2014 Sony Corporation



Digital HD Video Camera Recorder
HDR-CX240/CX240E/PJ240/PJ240E/PJ270/PJ270E/PJ275

Playback Function

Event View

You can play back recorded images by date of recording (Event View).



Scenario

You can view Highlight Scenario that you have saved.



Notes on use

4-531-544-11(1)

Copyright 2014 Sony Corporation



Digital HD Video Camera Recorder
HDR-CX240/CX240E/PJ240/PJ240E/PJ270/PJ270E/PJ275

Edit/Copy

[Send to Smartphone \(HDR-PJ275\)](#)

Transfer images recorded with this product to your smartphone.

[View on TV \(HDR-PJ275\)](#)

You can view images on your TV connected to the network by transferring images from this product without connecting this product and TV with a cable.

[Send to Computer \(HDR-PJ275\)](#)

Transfer images recorded with this product to your computer.

[Delete](#)

You can delete unnecessary images.

[Protect](#)

Protect movies and photos to avoid deleting them by mistake.

[Copy](#)

You can copy images stored on the recording media using this product.

[Notes on use](#)

4-531-544-11(1)

Copyright 2014 Sony Corporation



Digital HD Video Camera Recorder
HDR-CX240/CX240E/PJ240/PJ240E/PJ270/PJ270E/PJ275

Setup

[Media Select \(HDR-PJ270/PJ270E/PJ275\)](#)

You can select the recording medium on which the images will be saved.

[Media Info](#)

You can check the remaining recordable time and the approximate free and used space of the recording media.

[Format](#)

Formatting deletes all the movies and photos to recover recordable free space.

[Empty \(HDR-PJ270/PJ270E/PJ275\)](#)

Performing [Empty] deletes all the movies and photos in the media. It is recommended that you perform [Empty] before disposing of or transferring this product to another party to prevent leakage of your personal information.

[Repair Img. DB F.](#)

Repair the image database file when necessary, such as when the image database repair message appears.

[File Number](#)

You can select the way to assign file number of photos/MP4 movies.

[Data Code](#)

During playback, this product displays the information recorded automatically at the recording time.

[Volume](#)

You can adjust the volume of playback sound.

[Motion Interval ADJ](#)

Adjusts the residual image intervals of a motion shot video.

[Download Music \(HDR-CX240/PJ240/PJ270/PJ275\)](#)

You can transfer music files from audio CDs etc., to this product by connecting this product to a computer.

[Empty Music \(HDR-CX240/PJ240/PJ270/PJ275\)](#)

You can delete all music files stored on this product.

[WPS Push \(HDR-PJ275\)](#)

If your access point has a WPS button, you can register the access point to this product easily.



[Access point settings \(HDR-PJ275\)](#)

You can register your access point manually.



[Edit Device Name \(HDR-PJ275\)](#)

You can change the device name for Wi-Fi Direct etc.



[Disp MAC Address \(HDR-PJ275\)](#)

Display the MAC address of this product.



[SSID/PW Reset \(HDR-PJ275\)](#)

To change the device that is permitted to connect to this product, reset the SSID/password.



[Network Info Reset \(HDR-PJ275\)](#)

To change the access point to connect to, reset the connection information.



[TV Type](#)

You need to convert the signal depending on the horizontal to vertical ratio of the TV connected.



[HDMI Resolution](#)

Select the output image resolution when connecting this product to a TV with the HDMI cable.



[CTRL FOR HDMI](#)

When connecting this product to a BRAVIA Sync compatible TV with an HDMI cable, you can play back movies on this product by aiming the TV's Remote Commander at the TV.



[USB Connect](#)

Select this item if a USB connection does not start even when you connect this product to an external device with the Built-in USB Cable.



[USB Connect Setting](#)

You can set the USB transfer mode for connecting this product to a computer or other USB device.



[USB Power Supply](#)

Set whether to use USB power supplied function when this product is connected to the AC Adaptor or a USB device such as a computer.



[USB LUN Setting](#)

Improves compatibility with external devices by limiting the functions of the USB connection.



Beep

You can turn on or off the operation sound.

Monitor Brightness

You can adjust the brightness of the LCD monitor.

Airplane Mode (HDR-PJ275)

When you board an airplane, you can deactivate the Wi-Fi function temporarily.

Language Setting

You can select the language to be used on the LCD monitor.

Power Save

You can change the settings for the backlight of the LCD monitor and the power status of this product.

Initialize

All the settings return to the default.

Demo Mode

Set playback of the demonstration movie.

Date & Time Setting

Set the date & time settings.

Area Setting

You can adjust a time difference without stopping the clock. Select your local area when using this product in other time zones.

Notes on use

4-531-544-11(1)

Copyright 2014 Sony Corporation



Digital HD Video Camera Recorder
HDR-CX240/CX240E/PJ240/PJ240E/PJ270/PJ270E/PJ275

Check the charging time

Charging time

Informs you of the approximate time required to fully charge a fully discharged battery pack.



Notes on use

4-531-544-11(1)

Copyright 2014 Sony Corporation



Digital HD Video Camera Recorder
HDR-CX240/CX240E/PJ240/PJ240E/PJ270/PJ270E/PJ275

Expected recording and playback times for individual batteries

[Expected recording time with NP-BX1](#)

Informs you of the expected recording time with NP-BX1.



[Expected playback time with NP-BX1](#)

Informs you of the expected playback time with NP-BX1.



[Notes on use](#)

4-531-544-11(1)

Copyright 2014 Sony Corporation



Digital HD Video Camera Recorder
HDR-CX240/CX240E/PJ240/PJ240E/PJ270/PJ270E/PJ275

Expected movie recording time and number of recordable photos for the internal memory

[Notes on recording movies](#)

Read the precautions regarding movie recording.



[Expected recording time of movies](#)

Informs you of the expected recording time when saving on the internal memory.



[Expected number of recordable photos](#)

Informs you of the expected number of images you can save on the internal memory.



[Notes on use](#)

4-531-544-11(1)

Copyright 2014 Sony Corporation



Digital HD Video Camera Recorder
HDR-CX240/CX240E/PJ240/PJ240E/PJ270/PJ270E/PJ275

Expected movie recording time and number of recordable photos for memory cards

[Notes on recording movies](#)

Read the precautions regarding movie recording.



[Expected recording time of movies](#)

Informs you of the expected recording time of movies when saving on a memory card.



[Expected number of recordable photos](#)

Informs you of the expected number of images you can save on a memory card.



[Notes on use](#)

4-531-544-11(1)

Copyright 2014 Sony Corporation



Digital HD Video Camera Recorder
HDR-CX240/CX240E/PJ240/PJ240E/PJ270/PJ270E/PJ275

Bit-rate for each recording mode

[Bit-rate and recording pixels](#)

Explains the bit-rate, pixels and aspect ratio of each recording mode for movies (movie + audio, etc).



[Notes on use](#)

4-531-544-11(1)

Copyright 2014 Sony Corporation



Digital HD Video Camera Recorder
HDR-CX240/CX240E/PJ240/PJ240E/PJ270/PJ270E/PJ275

Pixels recorded at each image size of photos

[Recording pixels and aspect ratio](#)

Explains the photo recording pixels and the aspect ratio.



[Notes on use](#)

4-531-544-11(1)

Copyright 2014 Sony Corporation



Digital HD Video Camera Recorder
HDR-CX240/CX240E/PJ240/PJ240E/PJ270/PJ270E/PJ275

Precautions

[About the AVCHD format](#)

Explains the AVCHD standard.



[About the memory card](#)

Read the precautions regarding memory cards.



[About the battery pack](#)

Read the battery information.



Notes on use

4-531-544-11(1)

Copyright 2014 Sony Corporation



Digital HD Video Camera Recorder
HDR-CX240/CX240E/PJ240/PJ240E/PJ270/PJ270E/PJ275

Handling of this product

[On use and care](#)

Read the precautions, etc for using this product.

[On connecting to a computer or accessory etc.](#)

Read the information regarding connecting to your computer or an accessory.

[Notes on optional accessories](#)

Read the information on accessories (sold separately).

[On moisture condensation](#)

Read the information on moisture condensation.

[Notes on disposal/transfer the ownership of this product \(models equipped with the internal memory\)](#)

Read the notes on disposal/transfer of this product.

Notes on use

4-531-544-11(1)

Copyright 2014 Sony Corporation



Digital HD Video Camera Recorder
HDR-CX240/CX240E/PJ240/PJ240E/PJ270/PJ270E/PJ275

Maintenance

[On handling the LCD monitor](#)

Read the information on care of the LCD monitor.



[To clean the casing and the projector lens surface \(models with the projector\)](#)

Read the information on care of the casing and lens.



[About care and storage of the lens](#)

Read the information on care and storage of the lens.



Notes on use

4-531-544-11(1)

Copyright 2014 Sony Corporation



Digital HD Video Camera Recorder
HDR-CX240/CX240E/PJ240/PJ240E/PJ270/PJ270E/PJ275

Using this product abroad

[Using this product abroad](#)

Read the information on using this product abroad.



[World time difference](#)

Check the time difference for cities worldwide.



Notes on use

4-531-544-11(1)

Copyright 2014 Sony Corporation



Digital HD Video Camera Recorder
HDR-CX240/CX240E/PJ240/PJ240E/PJ270/PJ270E/PJ275

Trademarks

[On trademarks](#)

Read the information on trademarks.



[Notes on use](#)

4-531-544-11(1)

Copyright 2014 Sony Corporation



Digital HD Video Camera Recorder
HDR-CX240/CX240E/PJ240/PJ240E/PJ270/PJ270E/PJ275

License

[Notes on the License](#)

Read the notes on the license.



[Notes on use](#)

4-531-544-11(1)

Copyright 2014 Sony Corporation



Digital HD Video Camera Recorder
HDR-CX240/CX240E/PJ240/PJ240E/PJ270/PJ270E/PJ275

Zoom magnifications

[Zoom magnifications](#)

Introduces the zoom magnifications you can set on this product for recording.



[Notes on use](#)

4-531-544-11(1)

Copyright 2014 Sony Corporation



Troubleshooting

Digital HD Video Camera Recorder
HDR-CX240/CX240E/PJ240/PJ240E/PJ270/PJ270E/PJ275

If you have problems

[If you have problems](#)

Explains the procedure to follow if you run into any problems using this product.



[Notes on use](#)

4-531-544-11(1)

Copyright 2014 Sony Corporation



Digital HD Video Camera Recorder
HDR-CX240/CX240E/PJ240/PJ240E/PJ270/PJ270E/PJ275

Overall operations

The power does not turn on.



This product does not operate even when the power is set to on.



The menu settings have been changed automatically.



This product gets warm.



A rattling noise is heard when this product is shaken.



Intelligent Auto is canceled.



Notes on use

4-531-544-11(1)

Copyright 2014 Sony Corporation



Troubleshooting

Digital HD Video Camera Recorder
HDR-CX240/CX240E/PJ240/PJ240E/PJ270/PJ270E/PJ275

Batteries/power sources

The power abruptly turns off.



The POWER/CHG (charge) lamp does not light while the battery pack is being charged.



The POWER/CHG (charge) lamp flashes while the battery pack is being charged.



The remaining battery power is not displayed correctly.



The battery pack is quickly discharged.



Notes on use

4-531-544-11(1)

Copyright 2014 Sony Corporation



Troubleshooting

Digital HD Video Camera Recorder
HDR-CX240/CX240E/PJ240/PJ240E/PJ270/PJ270E/PJ275

Monitor

- Menu items are grayed out. >
- The buttons do not appear on the LCD monitor. >
- The buttons on the LCD monitor quickly disappear. >
- There are dots in the shape of a grid on the monitor. >
- The backlight of the LCD monitor turns off if you do not attempt to operate this product for a while. >

Notes on use

4-531-544-11(1)

Copyright 2014 Sony Corporation



Digital HD Video Camera Recorder
HDR-CX240/CX240E/PJ240/PJ240E/PJ270/PJ270E/PJ275

Memory card

Operations using the memory card cannot be performed.



Images stored on the memory card cannot be deleted.



The data file name is not indicated correctly or flashes.



Images cannot be played back or the memory card is not recognized.



Notes on use

4-531-544-11(1)

Copyright 2014 Sony Corporation



Digital HD Video Camera Recorder
HDR-CX240/CX240E/PJ240/PJ240E/PJ270/PJ270E/PJ275

Recording

Pressing START/STOP or PHOTO does not record images.



Photos cannot be recorded.



The access lamp remains lit or flashing even if recording has stopped.



The imaging field looks different.



The actual recording time for movies is less than the expected recording time of the recording media.



This product stops recording.



There is a slight time lag between the moment when START/STOP is pressed and the actual movie recording starts or stops.



The auto focus does not function.



SteadyShot does not function.



Images cannot be recorded or played back correctly.



The subjects passing across this product very fast appear crooked.



Horizontal stripes appear on the images.



[Monitor Brightness] cannot be set.



Photos are recorded automatically.





Troubleshooting

Digital HD Video Camera Recorder
HDR-CX240/CX240E/PJ240/PJ240E/PJ270/PJ270E/PJ275

Playback

Images cannot be played back.



Photos cannot be played back.



The movie freezes.



An icon appears on a thumbnail.



No sound or only a quiet sound is heard during playback.



Notes on use

4-531-544-11(1)

Copyright 2014 Sony Corporation



Digital HD Video Camera Recorder
HDR-CX240/CX240E/PJ240/PJ240E/PJ270/PJ270E/PJ275

Wi-Fi

The wireless access point you want to connect to does not appear. (models with the Wi-Fi/NFC functions) 

[WPS Push] does not work. (models with the Wi-Fi/NFC functions) 

[Ctrl with Smartphone], [Send to Smartphone], [Send to Computer] or [View on TV] terminates prematurely. (models with the Wi-Fi/NFC functions) 

Cannot transfer movies to your smartphone. (models with the Wi-Fi/NFC functions) 

The shooting screen does not display smoothly. The connection is cut off. (models with the Wi-Fi/NFC functions) 

The NFC connection does not work. (models with the Wi-Fi/NFC functions) 

Notes on use

4-531-544-11(1)

Copyright 2014 Sony Corporation



Digital HD Video Camera Recorder
HDR-CX240/CX240E/PJ240/PJ240E/PJ270/PJ270E/PJ275

Editing movies/photos on this product

Unable to edit.



A movie cannot be divided.



The demonstration movies cannot be deleted. (models with the internal memory)



Notes on use

4-531-544-11(1)

Copyright 2014 Sony Corporation



Troubleshooting

Digital HD Video Camera Recorder
HDR-CX240/CX240E/PJ240/PJ240E/PJ270/PJ270E/PJ275

Playback on a TV

Neither image nor sound is played on the connected TV.



The top, bottom, right, and left edges of images are trimmed slightly on a connected TV.



The image appears distorted on the 4:3 TV.



Black bands appear at the top and bottom of the LCD monitor of the 4:3 TV.



Notes on use

4-531-544-11(1)

Copyright 2014 Sony Corporation



Troubleshooting

Digital HD Video Camera Recorder
HDR-CX240/CX240E/PJ240/PJ240E/PJ270/PJ270E/PJ275

Copying/Connecting to other devices

Images are not copied correctly.



[Notes on use](#)

4-531-544-11(1)

Copyright 2014 Sony Corporation



Troubleshooting

Digital HD Video Camera Recorder
HDR-CX240/CX240E/PJ240/PJ240E/PJ270/PJ270E/PJ275

Connecting to a computer

[PlayMemories Home cannot be installed.](#)



[PlayMemories Home does not work correctly.](#)



[This product is not recognized by the computer.](#)



[Notes on use](#)

4-531-544-11(1)

Copyright 2014 Sony Corporation



Troubleshooting

Digital HD Video Camera Recorder
HDR-CX240/CX240E/PJ240/PJ240E/PJ270/PJ270E/PJ275

Self-diagnosis display/Warning indicators

[Self-diagnosis display](#)



[Notes on use](#)

4-531-544-11(1)

Copyright 2014 Sony Corporation



Troubleshooting

Digital HD Video Camera Recorder
HDR-CX240/CX240E/PJ240/PJ240E/PJ270/PJ270E/PJ275

Warning messages

Warning Indicators

If warning messages appear, follow the instructions.



Notes on use

4-531-544-11(1)

Copyright 2014 Sony Corporation



Digital HD Video Camera Recorder
HDR-CX240/CX240E/PJ240/PJ240E/PJ270/PJ270E/PJ275

Model Information

In this Help Guide, the differences in the specifications for each model are described together.

If you find the description “Models with ...” like below, confirm in this chapter whether the description applies to this product.

- (models with the internal memory)
- (models with the NTSC color system)

To confirm the model name of this product

See the bottom of this product.

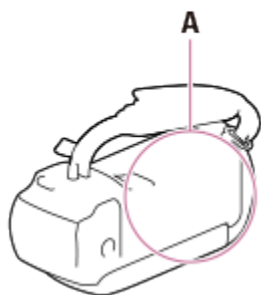

A: Model name (HDR-xxxx)

Differences in functions

Models with the internal memory: HDR-PJ270/PJ270E/PJ275

Models with the projector: HDR-PJ240/PJ240E/PJ270/PJ270E/PJ275

Models with the Wi-Fi/NFC functions: HDR-PJ275

Models with the NTSC color system: HDR-CX240/PJ240/PJ270/PJ275

Models with the PAL color system: HDR-CX240E/PJ240E/PJ270E

Models with the USB IN/OUT jacks: HDR-CX240/PJ240/PJ270/PJ275

Models with the USB Output only jack: HDR-CX240E/PJ240E/PJ270E

Note

- For the following items, the descriptions are explained with the model name.
 - _Parts and controls
 - _Menu items
 - _Expected recording time of movies
 - _Expected number of recordable photos

Related Topic

- [Parts and controls \(front/top\)](#)

- Parts and controls (LCD monitor)
- Parts and controls (side)
- Parts and controls (back/bottom)
- Screen indicators
- Expected recording time of movies
- Expected number of recordable photos

Notes on use

4-531-544-11(1)

Copyright 2014 Sony Corporation



Digital HD Video Camera Recorder
HDR-CX240/CX240E/PJ240/PJ240E/PJ270/PJ270E/PJ275

Parts and controls (front/top)

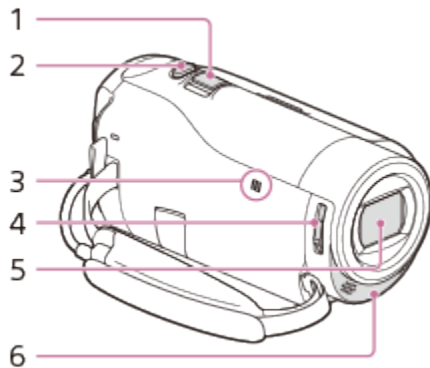

1. Power zoom lever
2. PHOTO button
3. N mark (HDR-PJ275)
NFC: Near Field Communication
4. LENS COVER switch
5. Lens (ZEISS lens)
6. Built-in microphone

Notes on use

4-531-544-11(1)

Copyright 2014 Sony Corporation



Digital HD Video Camera Recorder
HDR-CX240/CX240E/PJ240/PJ240E/PJ270/PJ270E/PJ275

Parts and controls (LCD monitor)

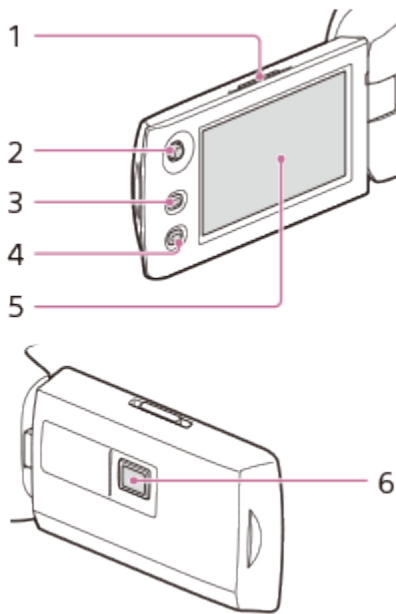

1. PROJECTOR FOCUS lever (HDR-PJ240/PJ240E/PJ270/PJ270E/PJ275)
2. Multi-selector
3.  (View Images) button
4. PROJECTOR button (HDR-PJ240/PJ240E/PJ270/PJ270E/PJ275)
5. LCD monitor

If you rotate the LCD panel 180 degrees, you can close the LCD monitor with the screen facing out. This is convenient during playback operations.

6. Projector lens (HDR-PJ240/PJ240E/PJ270/PJ270E/PJ275)

Notes on use

4-531-544-11(1)

Copyright 2014 Sony Corporation



Digital HD Video Camera Recorder
HDR-CX240/CX240E/PJ240/PJ240E/PJ270/PJ270E/PJ275

Parts and controls (side)

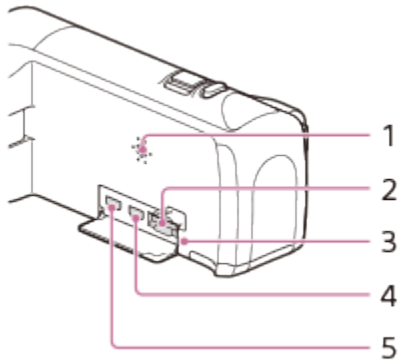

1. Speaker
2. Memory card slot
3. Memory card access lamp
While the lamp is lit or flashing, this product is reading or writing data.
4. HDMI OUT jack
5. PROJECTOR IN jack (HDR-PJ240/PJ240E/PJ270/PJ270E/PJ275)

Notes on use

4-531-544-11(1)

Copyright 2014 Sony Corporation



Digital HD Video Camera Recorder
 HDR-CX240/CX240E/PJ240/PJ240E/PJ270/PJ270E/PJ275

Parts and controls (back/bottom)

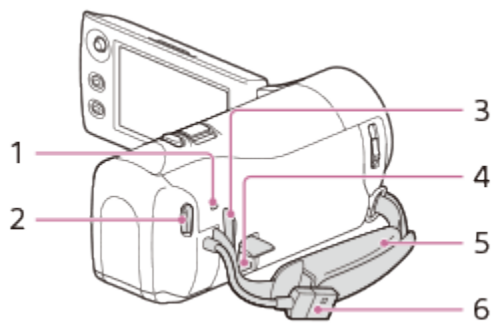

- 1. POWER/CHG (charge) lamp
- 2. START/STOP button
- 3. Loop for a shoulder belt
- 4. MULTI Terminal
 This terminal does not support VMC-AVM1 Adaptor Cable (sold separately). You cannot use accessories via an A/V Remote Connector.
- 5. Grip belt
- 6. Built-in USB Cable

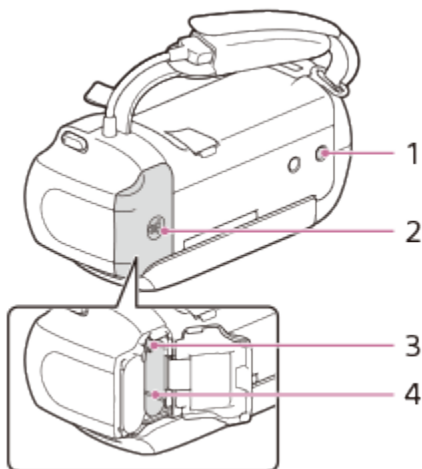

- 1. Tripod receptacle
 Attach a tripod (sold separately: the length of the screw must be less than 5.5 mm (7/32 in.)). Depending on the specifications of the tripod, this product may not attach in the proper direction.
- 2. Battery cover
- 3. Battery release lever
- 4. Battery pack

To fasten the grip belt

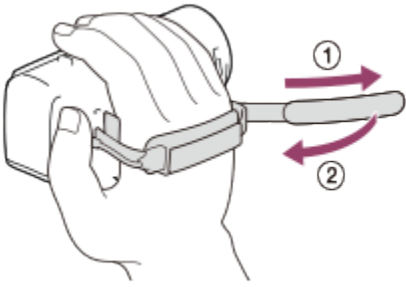

Notes on use

4-531-544-11(1)

Copyright 2014 Sony Corporation



Digital HD Video Camera Recorder
 HDR-CX240/CX240E/PJ240/PJ240E/PJ270/PJ270E/PJ275

Screen indicators

The following indicators appear when you change the settings.

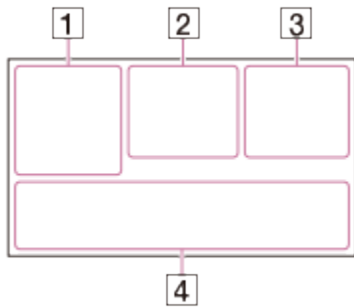

On the left side of the screen (1)

- MENU button
- Self-timer recording
- [Airplane Mode] set to [On]
- Fader
- [Face Detection] set to [Off]
- [Smile Shutter]
- Manual focus
- Scene Selection
- White Balance
- SteadyShot off
- Intelligent Auto

At the center of the screen (2)

- Slideshow Set
- Warning
- Playback mode
- REC /STBY** Recording mode
 - AE/AF lock
- NFC
- Wi-Fi
- Picture Effect

On the right side of the screen (3)

- 60i** Frame rate (60p/50p/60i/50i), recording mode (PS/FX/FH/HQ/LP) and movie size
- Dual Video REC

 Remaining battery

 Recording/playback/editing media

0:00:00 Counter (hour:minute:second)

00min Estimated recording time

9999 **16:9**  **9.2M** Approximate number of recordable photos and photo size

101 ▶ Playback folder of the memory card

100/112 Current playing movie or photo/Number of total recorded movies or photos

At the bottom of the screen (4)

 [Wind Noise Reduct.] set to [On]

 Blt-in Zoom Mic

 Low Lux

 Exposure

 Intelligent Auto

 Data file name

 Protect

Note

- Indicators and their positions are approximate and may differ from what you actually see.
- Some indicators may not appear, depending on the model.

Related Topic

• [Screen display on the Event View screen](#)

Notes on use

4-531-544-11(1)

Copyright 2014 Sony Corporation



Digital HD Video Camera Recorder
HDR-CX240/CX240E/PJ240/PJ240E/PJ270/PJ270E/PJ275

Selecting items on the LCD monitor

Use the multi-selector to select the items on the LCD monitor.

1. Move the multi-selector towards ▲ / ▼ / ◀ / ▶ to select the desired item.
2. Press the center of the multi-selector to complete the selection.

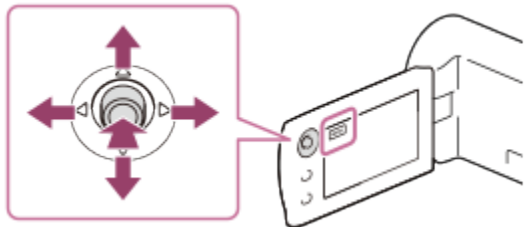

Notes on use

4-531-544-11(1)

Copyright 2014 Sony Corporation



Digital HD Video Camera Recorder
HDR-CX240/CX240E/PJ240/PJ240E/PJ270/PJ270E/PJ275

Supplied items

The numbers in () indicate the supplied quantity.

Camcorder (1)

AC Adaptor (1)

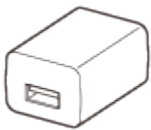

- The shape of the AC Adaptor varies depending on the countries/regions.

HDMI cable (1)

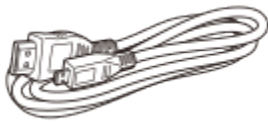

USB connection support cable (1)



Rechargeable battery pack NP-BX1 (1)



- When using this product while connected to a wall outlet (wall socket), such as while charging, make sure to attach the battery pack to this product.

“Operating Guide” (1)

Hint

- The USB connection support cable is designed for use with this product only. Use this cable when the Built-in USB Cable of this product is too short for connection.

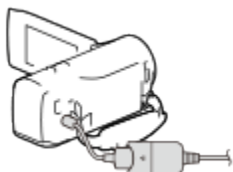



Digital HD Video Camera Recorder
HDR-CX240/CX240E/PJ240/PJ240E/PJ270/PJ270E/PJ275

Inserting the battery pack

Insert the battery pack to this product.

1. Open the battery cover by sliding it in the direction of arrow.

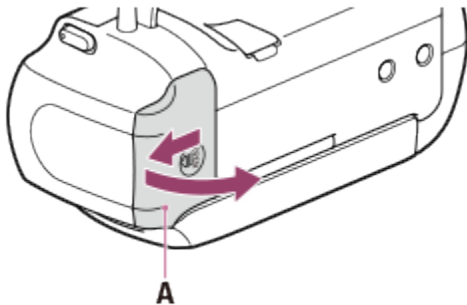

A: Battery cover

2. Insert the battery pack into this product.
 - Insert the battery pack into this product sliding the battery release lever.

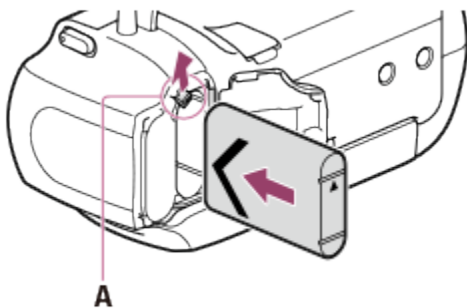

A: Battery release lever

3. Close the battery cover by sliding it in the direction of arrow.

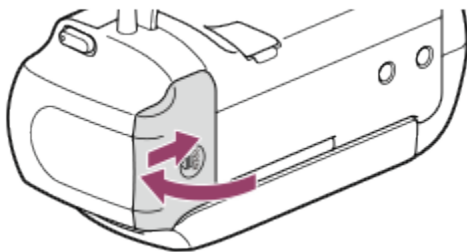

To remove the battery pack

Turn off this product, then open the battery cover (①), and then remove the battery pack from this product sliding the battery release lever (②).

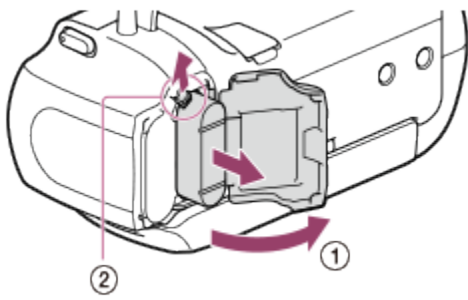

Note

- You cannot insert any battery pack other than the X type to this product.
- In the default setting, the power turns off automatically if you leave this product without any operation for about 2 minutes, to save battery power (Power Save).

Related Topic

● [Power Save](#)

[Notes on use](#)

4-531-544-11(1)

Copyright 2014 Sony Corporation



Digital HD Video Camera Recorder
HDR-CX240/CX240E/PJ240/PJ240E/PJ270/PJ270E/PJ275

Charging the battery pack using the AC Adaptor

Charge the battery pack using the supplied AC Adaptor. Insert the battery pack in advance.

1. Close the LCD monitor.

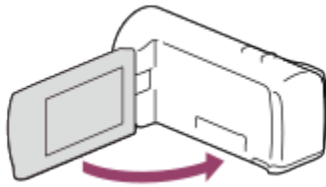

2. Pull out the Built-in USB Cable from this product.

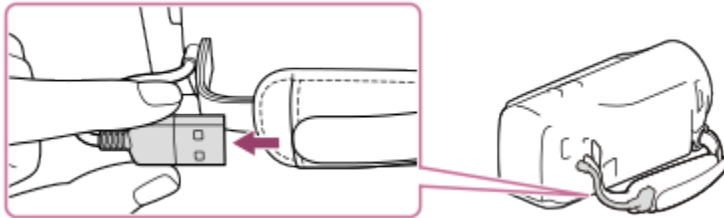

3. Connect this product to a wall outlet (wall socket) using the USB connection support cable and the AC Adaptor.
 - The POWER/CHG (charge) lamp lights orange.
 - The POWER/CHG (charge) lamp turns off when the battery pack is fully charged. Disconnect the USB connection support cable from this product.

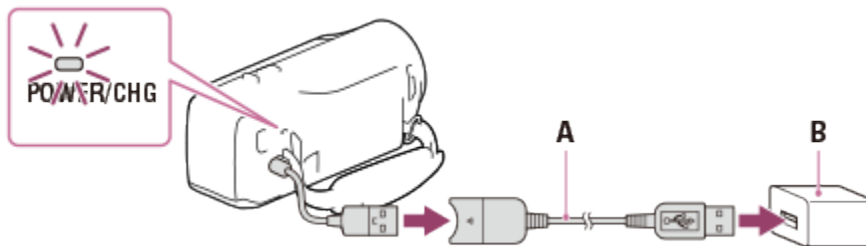

A: USB connection support cable

B: AC Adaptor

To store the Built-in USB Cable

Put the Built-in USB Cable back in the pocket on the grip belt after use.

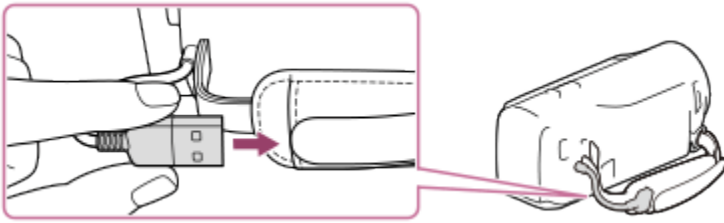

Note

- The shape of the AC Adaptor varies depending on the countries/regions.
- Be aware of the following notes on using the AC Adaptor.
 - _ Use a nearby wall outlet (wall socket) when using the AC Adaptor. Disconnect the AC Adaptor from the wall outlet (wall socket) immediately if any malfunction occurs while using this product.
 - _ Do not use the AC Adaptor placed in a narrow space, such as between a wall and furniture.
 - _ Do not short-circuit the USB jack of the AC Adaptor or battery terminal with any metallic objects. This may cause a malfunction.
 - _ To disconnect the AC Adaptor from this product, first disconnect the USB connection support cable from the AC Adaptor, and then disconnect this product from the USB connection support cable holding the connectors.

Hint

- It is recommended that you charge the battery in a temperature range of 10 °C to 30 °C (50 °F to 86 °F).

Related Topic

- [Charging time](#)
- [Expected recording time with NP-BX1](#)
- [Expected playback time with NP-BX1](#)
- [Using this product abroad](#)
- [Checking the remaining battery power](#)

Notes on use

4-531-544-11(1)

Copyright 2014 Sony Corporation



Digital HD Video Camera Recorder
HDR-CX240/CX240E/PJ240/PJ240E/PJ270/PJ270E/PJ275

Charging the battery pack using your computer

Charge the battery pack by connecting this product and your computer with the Built-in USB Cable. Insert the battery pack in advance.

1. Close the LCD monitor.

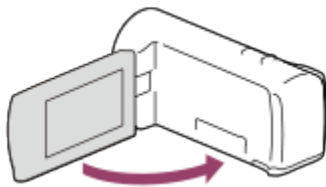

2. Pull out the Built-in USB Cable from this product.

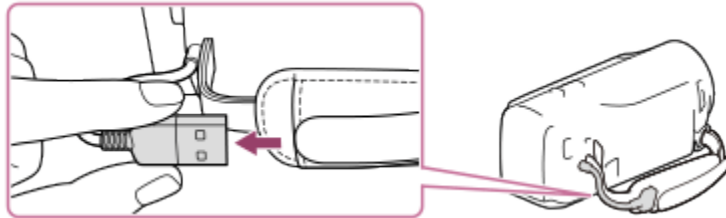

3. Connect this product to a running computer using the Built-in USB Cable.
 - The POWER/CHG (charge) lamp turns orange.
 - The POWER/CHG (charge) lamp turns off when the battery pack is fully charged. Disconnect the Built-in USB Cable from the computer, and then store it in the pocket on the grip belt.
 - If the Built-in USB Cable is not long enough for the connection, use the USB connection support cable.

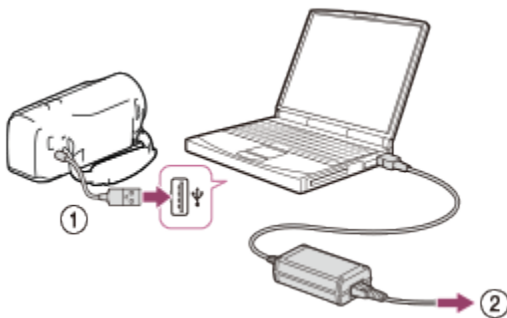

- ①: Built-in USB Cable
②: To a wall outlet (wall socket)

To put the Built-in USB Cable away

Put the Built-in USB Cable back in the pocket on the grip belt after use.

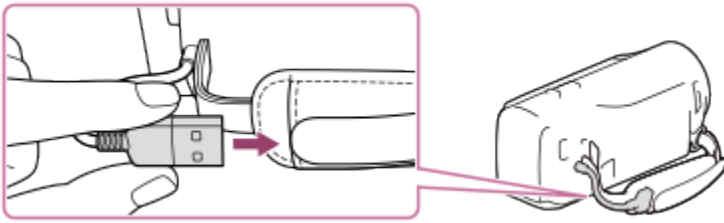

Hint

- It is recommended that you charge the battery in a temperature range of 10 °C to 30 °C (50 °F to 86 °F).

Related Topic

- [Charging time](#)
- [Expected recording time with NP-BX1](#)
- [Expected playback time with NP-BX1](#)
- [Using this product abroad](#)
- [Checking the remaining battery power](#)

Notes on use

4-531-544-11(1)

Copyright 2014 Sony Corporation



Digital HD Video Camera Recorder
HDR-CX240/CX240E/PJ240/PJ240E/PJ270/PJ270E/PJ275

Turning the power on

Turn on this product.

1. Open the LCD monitor of this product and turn the power on.

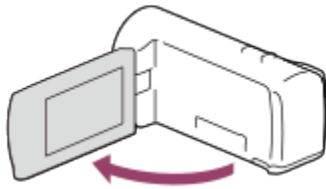

To turn off the power

Close the LCD monitor.

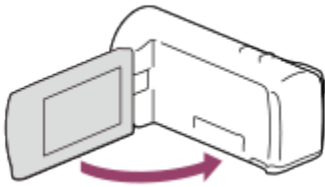

Notes on use

4-531-544-11(1)

Copyright 2014 Sony Corporation



Digital HD Video Camera Recorder
HDR-CX240/CX240E/PJ240/PJ240E/PJ270/PJ270E/PJ275

Using this product supplying power from a wall outlet (wall socket)

Supply power to this product using the AC Adaptor.

1. Insert the battery pack, and then pull out the Built-in USB Cable.

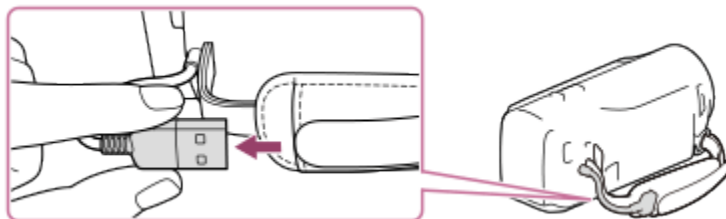

2. Connect this product to a wall outlet (wall socket) using the USB connection support cable and the AC Adaptor.

Note

- The battery pack is not charged, even when the AC Adaptor is connected to this product, as long as the power is on.
- To supply power via the AC Adaptor to this product, set [USB Power Supply] to [On]. Also, the battery pack must be inserted into this product.
- Even when connecting the AC Adaptor to this product, this product may subsidiarily use power from the battery pack depending on the environment in which you use this product.

Related Topic

- [Charging the battery pack using the AC Adaptor](#)
- [USB Power Supply](#)

Notes on use

4-531-544-11(1)

Copyright 2014 Sony Corporation



Digital HD Video Camera Recorder
HDR-CX240/CX240E/PJ240/PJ240E/PJ270/PJ270E/PJ275

Checking the remaining battery power

An icon indicating the remaining battery power is displayed.



Sufficient power remaining



Remaining battery level



Battery power depleted

- It will take approximately 1 minute to display the correct remaining battery power.
- The remaining battery power may not be displayed correctly depending on ambient conditions and the environment in which you are using this product.

Notes on use

4-531-544-11(1)

Copyright 2014 Sony Corporation



Digital HD Video Camera Recorder
HDR-CX240/CX240E/PJ240/PJ240E/PJ270/PJ270E/PJ275

Setting the language, date and time

Set the language, date and time when using this product for the first time.

1. Open the LCD monitor of this product and turn the power on.
2. Select the desired language, then select [Next].

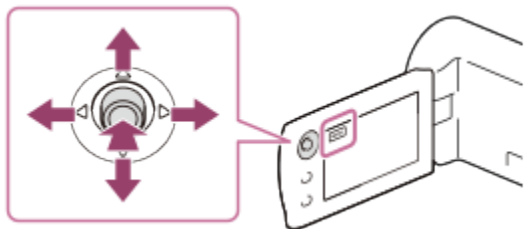

Hint

- Select the button on the LCD monitor using the multi-selector.

3. Select the desired geographical area with / , then select [Next].



4. Set [Daylight Savings] or [Summer Time], select the date format and the date and time.
 - If you set [Daylight Savings] or [Summer Time] to [On], the clock advances 1 hour.
 - When you select the date and time, select one of the items and adjust the value with / .
 - When you select - , the date and time setting operation is complete.

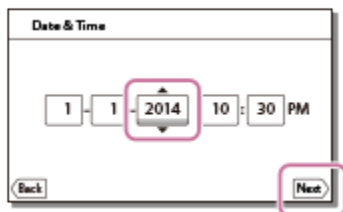

Hint

- The date and time are recorded automatically and can be displayed only during playback. To display them, select - [Setup] - [Playback Settings] - [Data Code] - [Date/Time].



Digital HD Video Camera Recorder
HDR-CX240/CX240E/PJ240/PJ240E/PJ270/PJ270E/PJ275

Adjusting the angle of the LCD monitor for easier viewing

You can adjust the angle of the LCD monitor for easier viewing.

1. First open the LCD monitor 90 degrees to this product (①), and then adjust the angle (②).

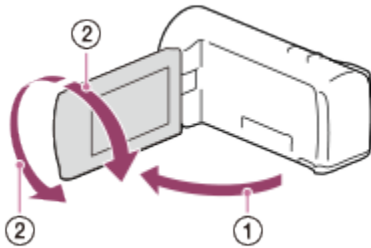

Notes on use

4-531-544-11(1)

Copyright 2014 Sony Corporation



Digital HD Video Camera Recorder
HDR-CX240/CX240E/PJ240/PJ240E/PJ270/PJ270E/PJ275

Displaying items on the LCD monitor

Items on the LCD monitor disappear if you do not operate this product for a few seconds after you turn this product on or switch between the movie recording and photo shooting modes. To display items on the LCD monitor again, operate the multi-selector.

Hint

- To keep the LCD monitor active, use [Display Setting] to change the setting.

Related Topic

[Display Setting](#)

Notes on use

4-531-544-11(1)

Copyright 2014 Sony Corporation



Digital HD Video Camera Recorder
HDR-CX240/CX240E/PJ240/PJ240E/PJ270/PJ270E/PJ275

Inserting a memory card

Insert a memory card into this product.

1. Open the cover and insert the memory card until it clicks.
 - microSD memory card: Insert the memory card straight in the direction shown in figure A until it clicks.
 - Memory Stick Micro (M2) media: Insert the memory card straight in the direction shown in figure B until it clicks.

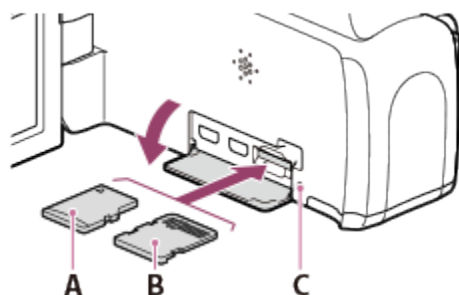

- A: Label side
B: Terminal side
C: Access lamp

Note

- To ensure stable operation of the memory card, it is recommended to format the memory card with this product before the first use. Formatting the memory card will erase all the data stored on it and the data will be irrecoverable. Save your important data on your PC, etc.
- If [Failed to create a new Image Database File. It may be possible that there is not enough free space.] is displayed, format the memory card.
- Confirm the direction of the memory card. If you forcibly insert the memory card in the wrong direction, the memory card, memory card slot, or image data may be damaged.
- Do not insert any memory card other than those that fit into the memory card slot. Doing so may cause a malfunction.
- When inserting or ejecting the memory card, be careful so that the memory card does not pop out and drop.
- Memory card will not be recognized by this product unless it is inserted straight in the correct direction.
- If [Preparing image database file. Please wait.] is displayed, wait until the message disappears.

Hint

- To eject the memory card, open the cover and lightly push the memory card in once.

- Displaying items on the LCD monitor
- Expected recording time of movies
- Expected number of recordable photos
- Types of memory card you can use with this product
- Media Select (HDR-PJ270/PJ270E/PJ275)
- Format

Notes on use

4-531-544-11(1)

Copyright 2014 Sony Corporation



Digital HD Video Camera Recorder
HDR-CX240/CX240E/PJ240/PJ240E/PJ270/PJ270E/PJ275

Types of memory card you can use with this product

The following types of memory cards can be used with this product.

Types of Memory Stick media you can use with this product

In this Help Guide, the following Memory Stick media you can use with this product is called Memory Stick Micro media.

- Memory Stick Micro (Mark2) media

Note

- Memory Stick Micro media with a capacity up to 16 GB have been confirmed to operate properly with this product.

Types of SD memory card you can use with this product

In this Help Guide, the following types of microSD cards you can use with this product are called “microSD card.”

- microSD memory card
- microSDHC memory card
- microSDXC memory card

Note

- For recording movies, use the card of Class 4 or faster.
- microSD cards with a capacity up to 64 GB have been confirmed to operate properly with this product.

Related Topic

- [Expected recording time of movies](#)
- [Expected number of recordable photos](#)

[Notes on use](#)

4-531-544-11(1)

Copyright 2014 Sony Corporation



Digital HD Video Camera Recorder
HDR-CX240/CX240E/PJ240/PJ240E/PJ270/PJ270E/PJ275

Recording movies

Record movies.

1. Open the lens cover.

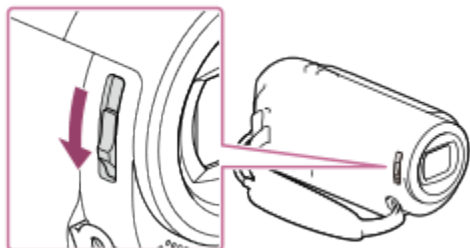

2. Open the LCD monitor of this product and turn the power on.

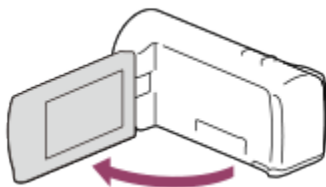

3. Press START/STOP to start recording.
 - To stop recording, press START/STOP again.

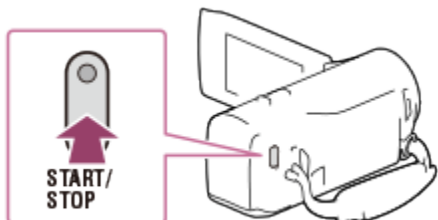

Note

- If you close the LCD monitor while recording movies, this product stops recording.
- The maximum continuous recordable time of a movie is about 13 hours.
- When a movie file exceeds 2 GB, the next movie file is created automatically.
- The following states will be indicated if data is still being written onto the recording media after recording has finished. During this time, do not apply shock or vibration to this product, or remove the battery pack or AC Adaptor.
 - Access lamp is lit or flashing
 - The media icon in the upper right of the LCD monitor is flashing
- The LCD monitor of this product can display recording images across the entire monitor (full pixel display).

However, this may cause slight trimming of the top, bottom, right, and left edges of images when played back on a TV which is not compatible with full pixel display. It is recommended you record images with [Grid Line] set to [On] using the outer frame of [Grid Line] as a guide.

Hint

- In the default setting, this product records an AVCHD movie and MP4 movie simultaneously in the movie recording mode. When you do not want to record an MP4 movie, set [Dual Video REC] to [Off].

Related Topic

- [Expected recording time of movies](#)
- [Media Select \(HDR-PJ270/PJ270E/PJ275\)](#)
- [Media Info](#)
- [Grid Line](#)
- [Dual Video REC](#)

[Notes on use](#)

4-531-544-11(1)

Copyright 2014 Sony Corporation



Digital HD Video Camera Recorder
HDR-CX240/CX240E/PJ240/PJ240E/PJ270/PJ270E/PJ275

Shooting photos

Shoot photos.

1. Open the lens cover.

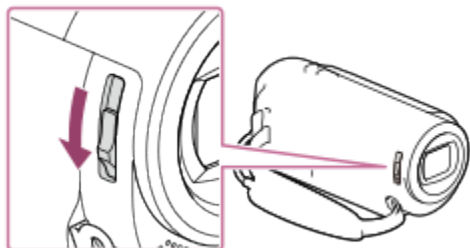

2. Open the LCD monitor of this product and turn the power on.

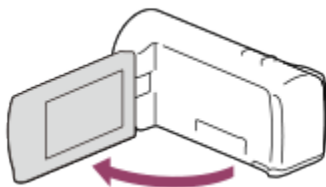

3. Select [MODE] on the LCD monitor, and then select the photo recording mode.

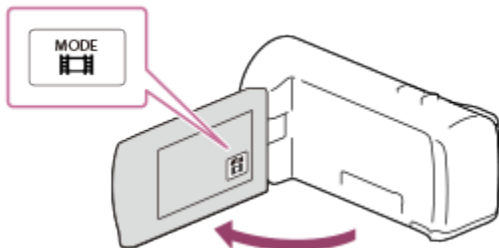

4. Press PHOTO lightly to adjust the focus, then press it fully.
 - When the focus is adjusted properly, the AE/AF lock indicator appears on the LCD monitor.

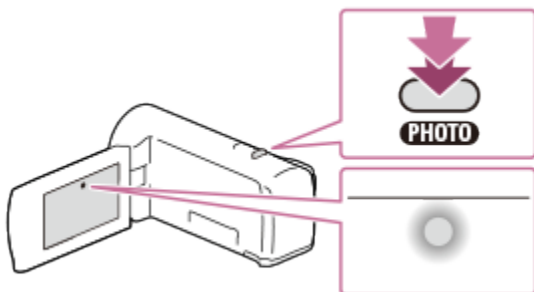

- The following states will be indicated if data is still being written onto the recording media after recording has finished. During this time, do not apply shock or vibration to this product, or remove the battery pack or AC Adaptor.
 - _ Access lamp is lit or flashing
 - _ The media icon in the upper right of the LCD monitor is flashing

Related Topic

● [Image Size](#)

Notes on use

4-531-544-11(1)

Copyright 2014 Sony Corporation



Digital HD Video Camera Recorder
HDR-CX240/CX240E/PJ240/PJ240E/PJ270/PJ270E/PJ275

Zooming

You can record an image with the subject magnified.

1. Move the power zoom lever to magnify or reduce the size of the image.

W:

Wider range of view (Wide angle)

T:

Close view (Telephoto)

- Move the power zoom lever slightly for a slower zoom. Move it further for a faster zoom.

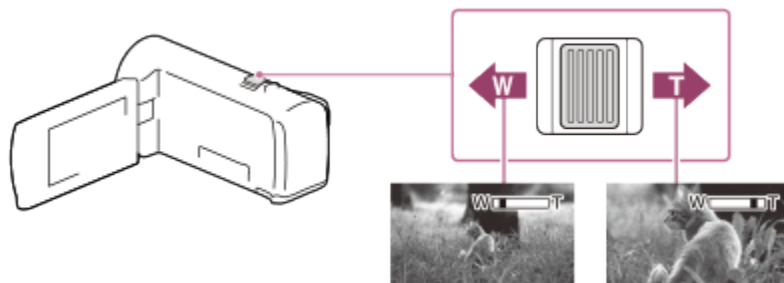

Note

- Be sure to keep your finger on the power zoom lever. If you move your finger off the power zoom lever, the operation sound of the power zoom lever may also be recorded.
- The minimum possible distance between this product and subject while maintaining sharp focus is about 1 cm (about 13/32 in.) for wide angle and about 80 cm (about 31 1/2 in.) for telephoto.

Related Topic

- [Digital Zoom](#)
- [Zoom magnifications](#)

Notes on use

4-531-544-11(1)

Copyright 2014 Sony Corporation



Digital HD Video Camera Recorder
HDR-CX240/CX240E/PJ240/PJ240E/PJ270/PJ270E/PJ275



Capturing photos during movie recording (Dual Capture)

You can shoot photos during movie recording.

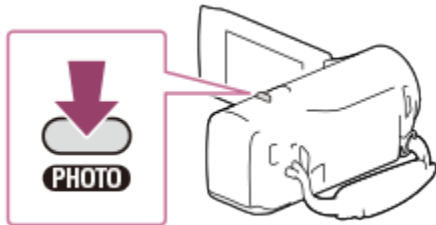
1. Press PHOTO during movie recording to capture still photos.



Note

- You may not be able to shoot photos depending on the setting in [ REC Mode] and [ Frame Rate].
- You cannot capture photos during movie recording in the following situation(s):
 - When an item of [Picture Effect] is selected

Related Topic

- [REC Mode](#)
- [Frame Rate](#)
- [Picture Effect](#)

Notes on use

4-531-544-11(1)

Copyright 2014 Sony Corporation



Digital HD Video Camera Recorder
HDR-CX240/CX240E/PJ240/PJ240E/PJ270/PJ270E/PJ275

Recording in mirror mode

You can rotate the LCD monitor 180 degrees so the LCD monitor faces toward you to record yourself.

1. Open the LCD monitor 90 degrees to this product (①), then rotate it 180 degrees to the lens side (②), and then start recording.

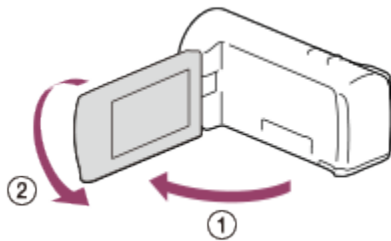

Hint

- A mirror-image of the subject appears on the LCD monitor, but the image will be normal when recorded.

Notes on use

4-531-544-11(1)

Copyright 2014 Sony Corporation



Digital HD Video Camera Recorder
HDR-CX240/CX240E/PJ240/PJ240E/PJ270/PJ270E/PJ275

Intelligent Auto

This product records images after selecting the most suitable setting for the subjects or the situation automatically.

- Select - [On] - on the recording screen of movies or photos.
 - To cancel the Intelligent Auto function, select - [Off] - .



- Point this product toward the subject and start recording.
 - The icons that correspond to the conditions detected are displayed.



About the detectable scenes

Face detection: (Portrait), (Baby)

Scene detection: (Backlight), (Landscape), (Night Scene), (Spotlight), (Low light), (Macro)

Camera-shake detection: (Tripod)

Note

- This product may not detect the expected scene or subject, depending on the recording conditions.

Notes on use

4-531-544-11(1)

Copyright 2014 Sony Corporation





Digital HD Video Camera Recorder
HDR-CX240/CX240E/PJ240/PJ240E/PJ270/PJ270E/PJ275

Playing movies and photos from the Event View screen

You can search for recorded images by date and time of recording (Event View).

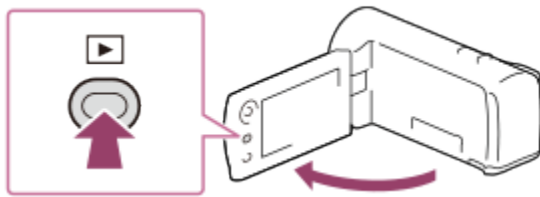
1. Open the LCD monitor and press  (View Images) to enter the playback mode.
 - You can also operate by selecting  (View Images) on the LCD monitor.



2. Select  /  to move the desired event to the center (①) and then select it (②).
 - This product displays recorded images as an event automatically, based on the date and time.

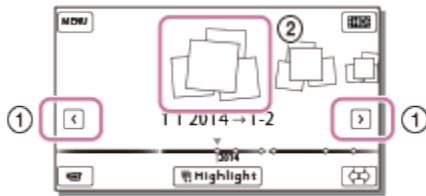

3. Select the image.
 - This product plays from the selected image to the last image in the event.

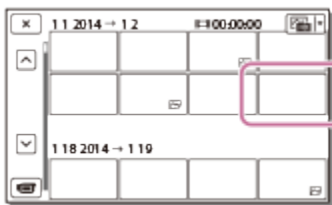

4. Select the appropriate buttons on the LCD monitor for various playback operations.

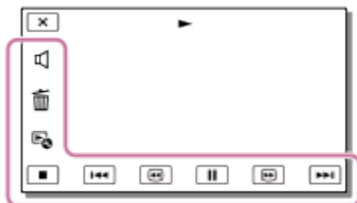



Buttons for playback operations

 /  : Previous/Next

 : Delete

 /  : Fast-reverse/fast-forward

 : Context

 /  : Play/Pause

 : Stop







 : Play/stop slide show

 : Motion shot video

Note

- To prevent your image data from being lost, save all your recorded images on external media periodically.
- Some buttons described above may not appear, depending on the image being played back.
- In the default setting, a protected demonstration movie is pre-recorded (models with the internal memory).

Hint

- As you repeat selecting  /  during playback, movies are played as fast as about 5 times - about 10 times - about 30 times - about 60 times.
- Select  /  during pause to play movies slowly.
- To repeat Slideshow, select  - [Slideshow Set] when  is selected with the Switch Image Type button.

Related Topic

- [Send to Computer \(models with the Wi-Fi/NFC functions\)](#)
- [Protect](#)

Notes on use

4-531-544-11(1)

Copyright 2014 Sony Corporation



Digital HD Video Camera Recorder
 HDR-CX240/CX240E/PJ240/PJ240E/PJ270/PJ270E/PJ275

Screen display on the Event View screen

Explains items displayed on the Event View screen.

Event View screen

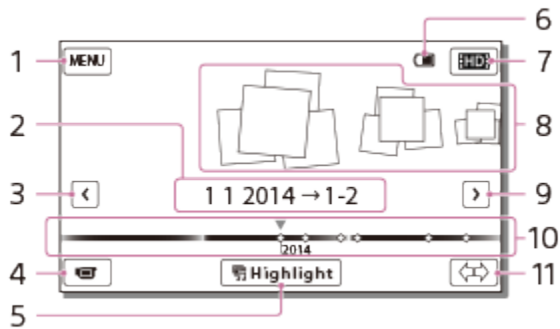

1. To the MENU screen
2. Event name
3. To the previous event
4. To the movie/photo recording mode
5. To play back short movies (Highlight Playback)
6. Remaining battery
7. To switch movie format (HD/MP4)
8. Events
9. To the next event
10. Time-line bar
11. To change Event Scale (approx. 3 months/1.5 years)

Index screen

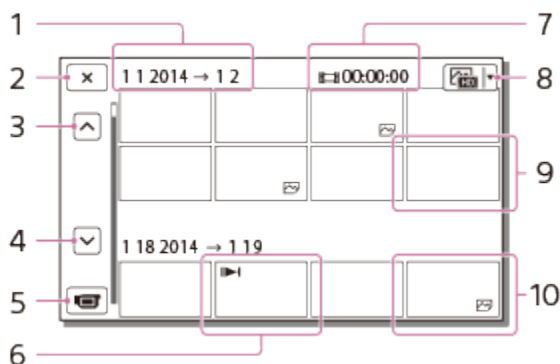

1. Event name
2. To close the index screen
3. To the previous event
4. To the next event
5. To the movie/photo recording mode
6. Last played image
7. Recorded time/number of photos
8. To switch between the movie/photo playback screen
9. Movie
10. Photo

Hint

- Reduced-size images which enable you to view many images at the same time on an index screen are called “thumbnails.”

Related Topic

 [Event View](#)

[Notes on use](#)

4-531-544-11(1)

Copyright 2014 Sony Corporation



Digital HD Video Camera Recorder
 HDR-CX240/CX240E/PJ240/PJ240E/PJ270/PJ270E/PJ275

Playing back a short movie (Highlight Playback)

You can enjoy movies and photos as a short movie.

1. Open the LCD monitor and press (View Images) to enter the playback mode.
 - You can also operate by selecting (View Images) on the LCD monitor.

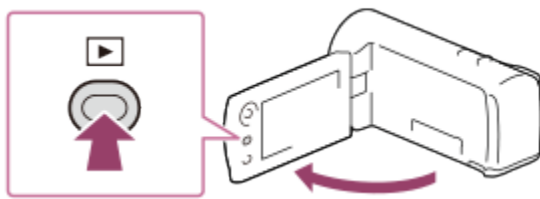

2. Display the desired event at the center of the Event View, and select [Highlight].



3. Play a movie or a photo.



4. Select the desired operation when the highlight playback finishes.

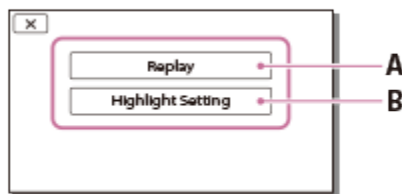

A: This product plays the Highlight Playback scenes again.
 B: You can change the settings for Highlight Playback.

Buttons for playback operations

: Previous/Next

: Volume

 : Context

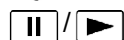
 : Play/Pause

 : Stop

Note

- MP4 movies cannot be played using the Highlight Playback function.
- Highlight Playback scenes will change each time you select a Highlight Playback.
- The [Playback Range] setting is cleared when the Highlight Playback stops.
- After the music file is transferred to this product, if you cannot play the music, the music file may be damaged. Delete the music file by selecting **MENU** - [Setup] - [ Playback Settings] - [Empty Music], then transfer the music file again. You can restore the music data recorded on this product at the default using “Music Transfer.” For operating instructions, see “Music Transfer” help (models with the USB IN/OUT jacks).

Related Topic

 [Empty Music \(HDR-CX240/PJ240/PJ270/PJ275\)](#)

Notes on use

4-531-544-11(1)

Copyright 2014 Sony Corporation



Digital HD Video Camera Recorder
HDR-CX240/CX240E/PJ240/PJ240E/PJ270/PJ270E/PJ275

Changing the settings for Highlight Playback

You can set the playback range of the Highlight Playback and select a theme for Highlight Playback.

1. Select [Highlight Setting] on the LCD monitor before or after the Highlight Playback.
 - You can also change the setting by selecting  while this product is playing highlight scenes.

Descriptions of menu items

[Playback Range]

You can set the playback range (starting and ending date) of the Highlight Playback.

[Theme]

You can select a theme for Highlight Playback.

[Music]

You can select music.

[Audio mix]



The original sound is played back with the music.

[Length]

You can set the length of the Highlight Playback segment.

[Highlight Point]

You can set the points in a movie or photo that will be used in a Highlight Playback.

Play the desired movie, and select  - . Or play the desired photo and select .

 appears on the movie or photo that is used in a Highlight Playback.

To erase the points, select  - [Clear All Points].

Related Topic

- [Playing back a short movie \(Highlight Playback\)](#)

Notes on use

4-531-544-11(1)



Copyright 2014 Sony Corporation



Digital HD Video Camera Recorder
HDR-CX240/CX240E/PJ240/PJ240E/PJ270/PJ270E/PJ275

Saving Highlight Playback (Scenario Save)

You can save your favorite Highlight Playback as a “Scenario.” Up to 8 scenarios can be saved.

1. Select [Replay] on the LCD monitor after a Highlight Playback has finished.
2. When the Highlight Playback starts again, select  - [ Scenario Save].



Note

- The scenarios can be played on this product only.

Related Topic

- [Playing back a short movie \(Highlight Playback\)](#)
- [Playing back a saved scenario](#)

Notes on use

4-531-544-11(1)

Copyright 2014 Sony Corporation



Digital HD Video Camera Recorder
HDR-CX240/CX240E/PJ240/PJ240E/PJ270/PJ270E/PJ275

Playing back a saved scenario

You can play back Highlight Scenarios saved on this product.

1. Select **[MENU]** - **[Playback Function]** - **[Scenario]**, select the desired scenario, and then select **[OK]**.

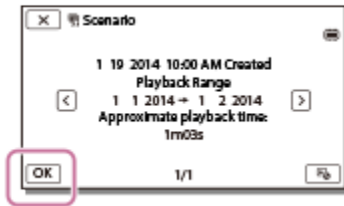

Hint

- To erase a saved scenario, select **[Erase]** - **[Erase All]** on the **[Scenario]** screen.

Related Topic

- [Saving Highlight Playback \(Scenario Save\)](#)

Notes on use

4-531-544-11(1)



Copyright 2014 Sony Corporation



Digital HD Video Camera Recorder
HDR-CX240/CX240E/PJ240/PJ240E/PJ270/PJ270E/PJ275

Playing MP4 movies (HD movie) (switching the movie format)

The format of a movie to be played or edited can be changed on the Event View screen.

1. Press  (View Images) to enter the playback mode.
2. Select the movie format you want to play from  or  at the top right corner of the LCD monitor.



- The format of a movie to be played or edited will be switched.

Notes on use

4-531-544-11(1)

Copyright 2014 Sony Corporation



Digital HD Video Camera Recorder
HDR-CX240/CX240E/PJ240/PJ240E/PJ270/PJ270E/PJ275

Notes on editing

- Some basic editing operations can be done on this product. If you want to do advanced editing operations, install and use the PlayMemories Home software.
- You cannot restore images once they are deleted. Save important movies and photos before deleting.
- Do not remove the battery pack or the AC Adaptor from this product while deleting or dividing the images. Doing so may damage the recording media.
- Do not eject the memory card while deleting or dividing images saved on the memory card.
- If you delete or divide movies that are included in saved scenarios, the scenarios will also be deleted.

Related Topic

- [Using the PlayMemories Home software](#)
- [Saving Highlight Playback \(Scenario Save\)](#)
- [Delete](#)
- [Dividing a movie](#)

Notes on use

4-531-544-11(1)



Copyright 2014 Sony Corporation



Digital HD Video Camera Recorder
HDR-CX240/CX240E/PJ240/PJ240E/PJ270/PJ270E/PJ275

Deleting the selected images



Select and delete unnecessary images.

1. Press the  button on this product to enter the playback mode.
2. On the Event View screen, select , and then select the movie format you want to delete.



3.  - [Edit/Copy]/[Edit] - [Delete].
4. Select [Multiple Images], and then select the type of image you want to delete.



5. Add check marks  to the movies or photos to be deleted and select .

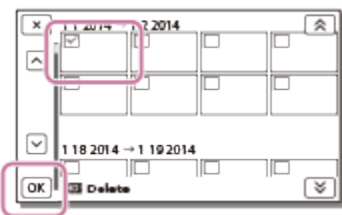

Hint

- You cannot delete protected images (). Release the protection of the data before deleting.
- To delete the unwanted part of a movie, divide the movie and then delete that part.

Related Topic



- [Protect](#)
- [Format](#)



Digital HD Video Camera Recorder
HDR-CX240/CX240E/PJ240/PJ240E/PJ270/PJ270E/PJ275

Deleting by date

Select unnecessary images by date of recording and delete them.

1. Press the  button on this product to enter the playback mode.
2. On the Event View screen, select , and then select the movie format you want to delete.



3.  - /[] - [].
4. Select .
5. Select the date you want to delete using /, and then select .

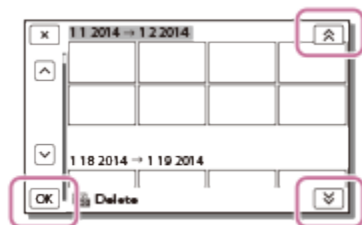

Related Topic

 [Format](#)

Notes on use

4-531-544-11(1)

Copyright 2014 Sony Corporation



Digital HD Video Camera Recorder
HDR-CX240/CX240E/PJ240/PJ240E/PJ270/PJ270E/PJ275

Dividing a movie

Split a recorded movie at your desired point.

1. Select  - [Divide] on the movie playback screen.



2. Select the point where you want to divide the movie into scenes using  / , and then select .

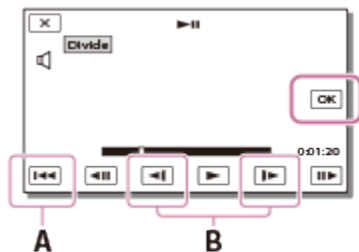

A: Returns to the beginning of the selected movie

B: Adjusts the dividing point with more precision

Note

- A slight difference may occur from the point where you select and the actual dividing point, as this product selects the dividing point based on about half-second increments.
- An MP4 movie cannot be divided.

Notes on use

4-531-544-11(1)

Copyright 2014 Sony Corporation





Digital HD Video Camera Recorder
HDR-CX240/CX240E/PJ240/PJ240E/PJ270/PJ270E/PJ275

Capturing a photo from a movie (models with the internal memory or models with the USB IN/OUT jacks)

You can capture images from movies recorded with this product.

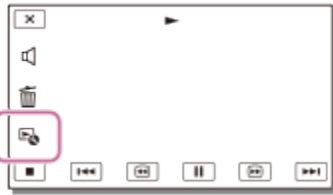
1. Select  - [Photo Capture] that appears on the playback screen of a movie.



2. Select the scene you want to capture a photo using  / , and then select .

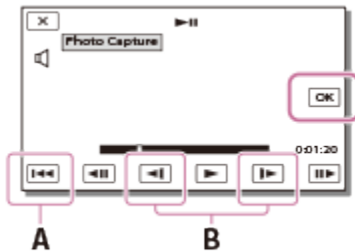

- The image size of the photo will be [2.1 M].

A: Returns to the beginning of the selected movie

B: Adjusts the capturing point with more precision

Note

- You cannot capture photos from a movie saved on a memory card. (models with the USB output only jack)

Hint

- The recording date and time of captured photos are the same as the recording date and time of the movies.
- If the movie you are capturing from has no data code, the recording date and time of the photo will be the date and time you captured from the movie.

Notes on use

4-531-544-11(1)



Copyright 2014 Sony Corporation



Digital HD Video Camera Recorder
HDR-CX240/CX240E/PJ240/PJ240E/PJ270/PJ270E/PJ275

Viewing trajectory of a moving object (Motion Shot Video)

You can view the trajectory of a fast-moving object.

1. On the Event View screen, play your desired movie, and then select .
To stop [Motion Shot Video] playback, select .



Note

- [Motion Shot Video] cannot be saved as movies.
- Trajectories of a moving object may not be plottable if the object is moving slowly or almost not at all.

Hint

- If this function does not work well, you can use  to change the interval of trajectories to be plotted.
- You can capture photos from your favorite scene of a [Motion Shot Video] ([Photo Capture]).

Related Topic

- [Playing movies and photos from the Event View screen](#)
- [Capturing photos during movie recording \(Dual Capture\)](#)
- [Motion Interval ADJ](#)

Notes on use

4-531-544-11(1)

Copyright 2014 Sony Corporation



Digital HD Video Camera Recorder
HDR-CX240/CX240E/PJ240/PJ240E/PJ270/PJ270E/PJ275

Notes on using the projector (models with the projector)

- The LCD monitor turns off while an image is being projected.
- Be careful of the following operations or situations while using the projector.
 - _ Make sure not to project images towards the eyes.
 - _ Make sure not to touch the projector lens.
 - _ The LCD monitor and the projector lens become hot while in use.
 - _ Using the projector shortens battery life (using the supplied AC Adaptor is recommended).
- The following operations are unavailable while you are using the projector.
 - _ Operation of this product with the LCD monitor closed
 - _ Several other functions
- When the projected images contain a lot of black, faint color unevenness may appear. This is caused by light reflection in the projector lens and is not a malfunction.

Notes on use

4-531-544-11(1)

Copyright 2014 Sony Corporation



Digital HD Video Camera Recorder
HDR-CX240/CX240E/PJ240/PJ240E/PJ270/PJ270E/PJ275

Using the built-in projector (models with the projector)

You can use a flat surface such as a wall as a screen to view recorded images using the built-in projector.

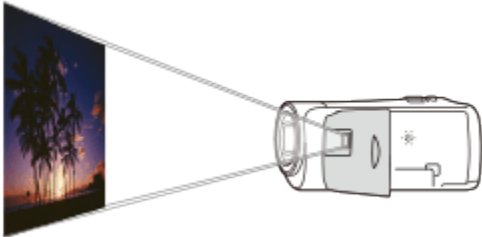

1. Face the projector lens towards a surface, such as a wall, and then press PROJECTOR.

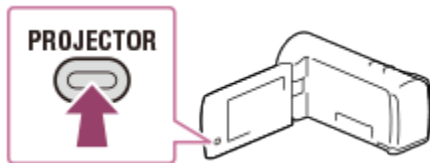

2. Select [Image Shot on This Device] on the LCD monitor.
3. Select [Project] on the LCD monitor.



- This screen appears the first time you use the built-in projector after this product is turned on.

4. Adjust the focus of the projected image using the PROJECTOR FOCUS lever.

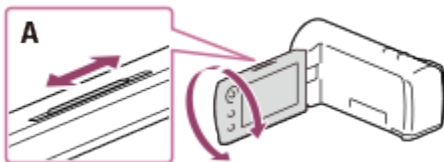

A: PROJECTOR FOCUS lever

- The projected image is larger when the distance between this product and the reflecting surface increase.
- It is recommended that you place this product further than 0.5 m (1.6 feet) away (approximate distance) from the surface that the images are to be projected onto.

5. Use the power zoom lever to move the selection frame that appears on the projection screen, and then press the PHOTO button.

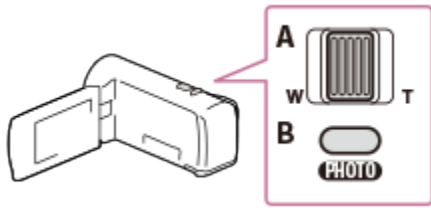

A: Power zoom lever

B: PHOTO button

- For details on playback, see “Playing movies and photos from the Event View screen.”
- Press PROJECTOR to turn off the projector.

Related Topic

- [Playing movies and photos from the Event View screen](#)

Notes on use

4-531-544-11(1)

Copyright 2014 Sony Corporation



Digital HD Video Camera Recorder
HDR-CX240/CX240E/PJ240/PJ240E/PJ270/PJ270E/PJ275

Using the projector for your computer or smartphone (models with the projector)

You can project images from a computer or smartphone using the built-in projector.

1. Connect the PROJECTOR IN jack of this product to an HDMI output jack of the other device using the HDMI cable (supplied).

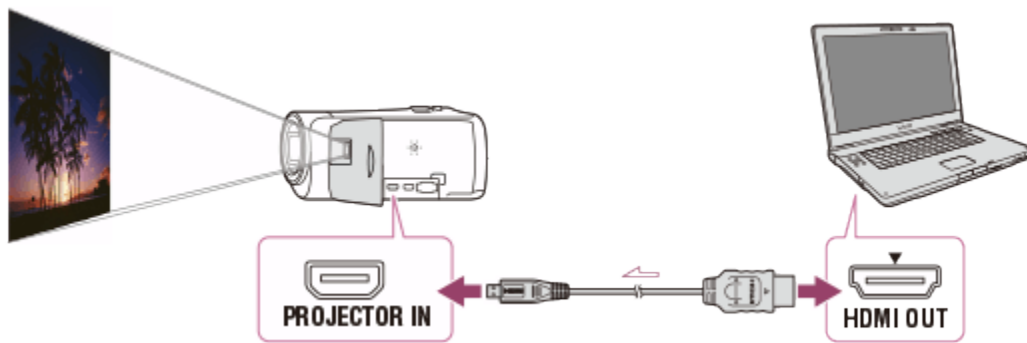

2. Face the projector lens towards a surface, such as a wall, and then press PROJECTOR.
3. Select [Image from External Device] on the LCD monitor.
4. Select [Project] on the LCD monitor.



- This screen appears the first time you use the built-in projector after this product is turned on.

5. Adjust the focus of the projected image using the PROJECTOR FOCUS lever.

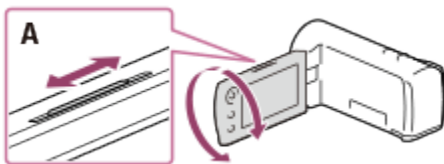

A: PROJECTOR FOCUS lever

- The further you position this product from the wall, the larger the screen will be.
- It is recommended that you place this product further than 0.5 m (1.6 feet) away (approximate distance) from the surface that the images are to be projected onto.

6. Select the image you want to view using your computer or smartphone.

- To turn off the projector, press PROJECTOR.

Note

- You can only operate the PROJECTOR FOCUS lever while projecting images.

Hint

- If the terminal of the device connected is not compatible with the HDMI cable (supplied), use an HDMI plug adaptor (sold separately).

Related Topic

- [On the HDMI cable](#)

Notes on use

4-531-544-11(1)

Copyright 2014 Sony Corporation



Digital HD Video Camera Recorder
HDR-CX240/CX240E/PJ240/PJ240E/PJ270/PJ270E/PJ275

Connecting this product to a high definition TV

You can play movies in high definition image quality (HD) by connecting this product to an HDMI compatible TV.

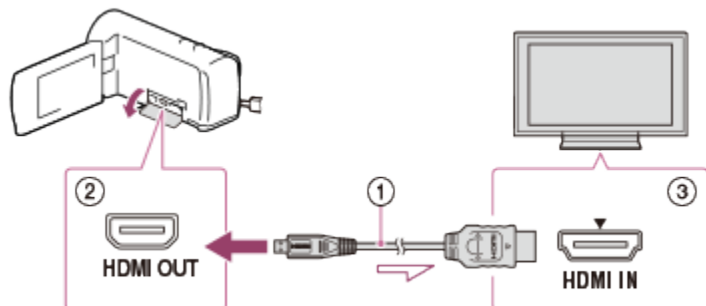

1. Switch the input on the TV to the connected jack.
2. Connect the HDMI cable (①) (supplied) to the HDMI OUT jack (②) on this product and to the HDMI input jack (③) on the TV.
3. Play a movie or a photo on this product.

Note

- Refer to the instruction manuals of the TV as well.
- Use the supplied AC Adaptor as the power source.
- If the TV does not have an HDMI input jack, use an AV cable (sold separately).
- If you connect this product to the TV using more than one type of cable to output images, HDMI input takes priority on the TV.

Notes on use

4-531-544-11(1)

Copyright 2014 Sony Corporation



Digital HD Video Camera Recorder
HDR-CX240/CX240E/PJ240/PJ240E/PJ270/PJ270E/PJ275

Using BRAVIA Sync

You can operate this product with the remote commander of your TV by connecting this product to a BRAVIA Sync compatible TV launched in 2008 or later with the HDMI cable.

You can operate the menu of this product by pressing the SYNC MENU button of the remote commander of your TV. You can display the LCD monitor of this product such as Event View, play selected movies or display selected photos by pressing up/down/left/right/enter buttons of the remote commander of your TV.

Note

- There may be some operations you cannot do with the remote commander.
- Set [CTRL FOR HDMI] to [On].
- Also set your TV accordingly. Refer to the instruction manual of the TV for details.
- The operation of BRAVIA Sync differs according to each model of BRAVIA. Refer to the instruction manual of your TV for details.
- If you turn off the TV, this product is turned off simultaneously.

Related Topic

● [CTRL FOR HDMI](#)

Notes on use

4-531-544-11(1)

Copyright 2014 Sony Corporation



Digital HD Video Camera Recorder
HDR-CX240/CX240E/PJ240/PJ240E/PJ270/PJ270E/PJ275

On Photo TV HD

This product is compatible with the Photo TV HD standard. Photo TV HD allows for highly-detailed, photo-like depiction of subtle textures and colors. By connecting Sony's Photo TV HD-compatible devices using the HDMI cable(*), a whole new world of photos can be enjoyed in breathtaking HD quality.

* The TV will automatically switch to the appropriate mode when displaying photos.

Notes on use

4-531-544-11(1)

Copyright 2014 Sony Corporation



Digital HD Video Camera Recorder
HDR-CX240/CX240E/PJ240/PJ240E/PJ270/PJ270E/PJ275

On the HDMI cable

- Use the supplied HDMI cable or an HDMI cable with the HDMI logo.
- Use an HDMI micro connector on one end (for this product), and a plug suitable for connecting your TV on the other end.
- Copyright-protected images are not output from the HDMI OUT jack of this product.
- Some TVs may not function correctly (e.g., no sound or image) with this connection.
- Do not connect the HDMI OUT jack of this product to an external device HDMI OUT jack, as malfunction may result. HDMI (High-Definition Multimedia Interface) is an interface to send both video/audio signals. The HDMI OUT jack outputs high quality images and digital audio.

Notes on use

4-531-544-11(1)

Copyright 2014 Sony Corporation



Digital HD Video Camera Recorder
HDR-CX240/CX240E/PJ240/PJ240E/PJ270/PJ270E/PJ275

Connecting this product to a non-high-definition TV

Play back images with this product connected to a TV by an AV cable (sold separately).

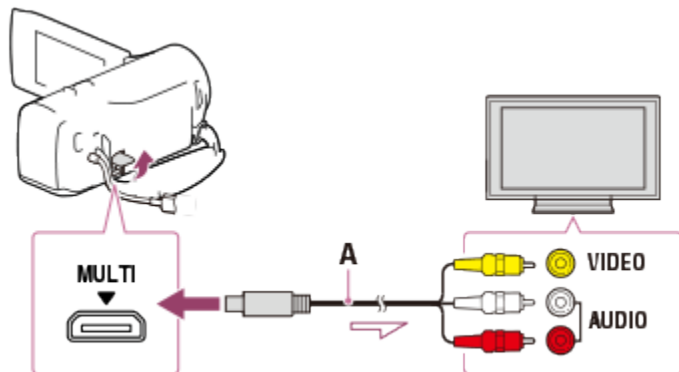

A: AV cable (sold separately)

1. Switch the input on the TV to the connected jack.
2. Connect the MULTI terminal of this product and the VIDEO/AUDIO jack of your TV using an AV cable (sold separately).
3. Play a movie or a photo on this product.

Note

- Refer to the instruction manuals of the TV as well.
- Use the supplied AC Adaptor as the power source.

Related Topic

- [TV Type](#)

Notes on use

4-531-544-11(1)

Copyright 2014 Sony Corporation



Digital HD Video Camera Recorder
HDR-CX240/CX240E/PJ240/PJ240E/PJ270/PJ270E/PJ275

Using the PlayMemories Home software

The PlayMemories Home software allows you to import movies and still images to your computer to use them in a variety of ways.

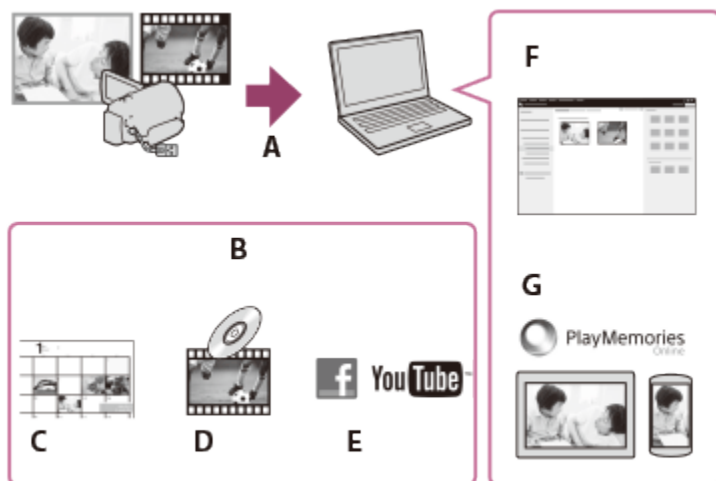

- A: Import images from this product
- B: The functions below are also available on a Windows PC
- C: View images in a calendar
- D: Create a movie disc
- E: Upload images to online services
- F: Play the imported images
- G: Share images on PlayMemories Online

Installing the PlayMemories Home software in your computer

PlayMemories Home can be downloaded from the following URL.

www.sony.net/pm/

Notes on use

4-531-544-11(1)

Copyright 2014 Sony Corporation



Digital HD Video Camera Recorder
HDR-CX240/CX240E/PJ240/PJ240E/PJ270/PJ270E/PJ275

Checking the computer system

You can check the system requirements for software at the following URL.

www.sony.net/pcenv/

Notes on use

4-531-544-11(1)

Copyright 2014 Sony Corporation



Digital HD Video Camera Recorder
HDR-CX240/CX240E/PJ240/PJ240E/PJ270/PJ270E/PJ275

Installing the PlayMemories Home software in your computer

Installing the PlayMemories Home software on your computer enables you to make use of your recorded images.

1. Access the following download page using an Internet browser on your computer to download the PlayMemories Home software.
www.sony.net/pm/
 - Install the software according to the on-screen instructions.
 - When the installation has completed, PlayMemories Home starts.
 - If the PMB (Picture Motion Browser) software is installed on your computer, it will be overwritten by the PlayMemories Home software. Use PlayMemories Home, the successor software of PMB.
2. Connect this product and your computer with the Built-in USB Cable.
 - If the PlayMemories Home software is already installed on your computer, connect this product to your computer. Functions that can be used with this product will then be available.

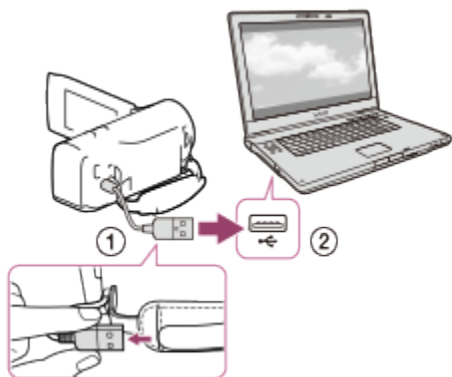

- ① Built-in USB Cable
- ② To the USB jack of your computer

Note

- Log on to your computer as an administrator.
- You may need to restart your computer. When prompted to restart, follow the on-screen instructions.
- Depending on the usage environment, DirectX can then be installed.

Hint



- For details on PlayMemories Home, refer to the help of PlayMemories Home.



Digital HD Video Camera Recorder
HDR-CX240/CX240E/PJ240/PJ240E/PJ270/PJ270E/PJ275

Disconnecting this product from the computer

Disconnect this product from the computer connected with the Built-in USB Cable.

1. Click  in the task tray, and then click .
 - If you use a Windows Vista computer, click  in the task tray.
2. Click the message displayed on the computer screen.
3. Select - on the LCD monitor, and then disconnect the Built-in USB Cable.

Note

- If you use a Mac computer, drag and drop the memory card or the drive icon to the Trash before disconnecting. The connection with the computer is released.
- If you use a Windows 7 or Windows 8 computer, a disconnection icon may not be displayed. In this case, you can release the connection without performing the above operations.

Notes on use

4-531-544-11(1)

Copyright 2014 Sony Corporation



Digital HD Video Camera Recorder
HDR-CX240/CX240E/PJ240/PJ240E/PJ270/PJ270E/PJ275

About the dedicated software for this product

You can download the dedicated software from the Sony website.

Windows:

www.sony.co.jp/imsoft/Win/

Mac:

www.sony.co.jp/imsoft/Mac/

Note

- The software that can be used with this product will differ, depending on the countries/regions.

Notes on use

4-531-544-11(1)

Copyright 2014 Sony Corporation



Digital HD Video Camera Recorder
HDR-CX240/CX240E/PJ240/PJ240E/PJ270/PJ270E/PJ275

Creating a Blu-ray disc

You can create a Blu-ray disc with an AVCHD movie previously imported to a computer.

To create a Blu-ray disc, the “BD Add-on Software” must be installed.

<http://support.d-imaging.sony.co.jp/BDUW/>

- Your computer must support the creation of Blu-ray discs.
- BD-R (unrewritable) and BD-RE (rewritable) media are available for creating Blu-ray discs. You cannot add contents to either type of disc after creating the disc.
- To play back a Blu-ray disc that has been created with a movie that was recorded in [60p Quality **PS**] (models with the NTSC color system) / [50p Quality **PS**] (models with the PAL color system) image quality, you need a device that complies with the AVCHD Ver. 2.0 format.

Notes on use

4-531-544-11(1)

Copyright 2014 Sony Corporation



Digital HD Video Camera Recorder
HDR-CX240/CX240E/PJ240/PJ240E/PJ270/PJ270E/PJ275

Creating a disc with a recorder

You can copy images on this product onto a disc or video cassette. Connect this product to a disc recorder with an AV cable (sold separately).

Note

- After inserting the battery pack to this product, connect this product to a wall outlet (wall socket) using the supplied AC Adaptor for this operation.
- Refer to the instruction manual supplied with the device connected.

1. Insert the recording medium in the recording device (a disc recorder, etc.).
 - If your recording device has an input selector, set it to the input mode.
2. Connect this product to the recording device with an AV cable (sold separately).
 - Connect this product to the input jacks of the recording device.

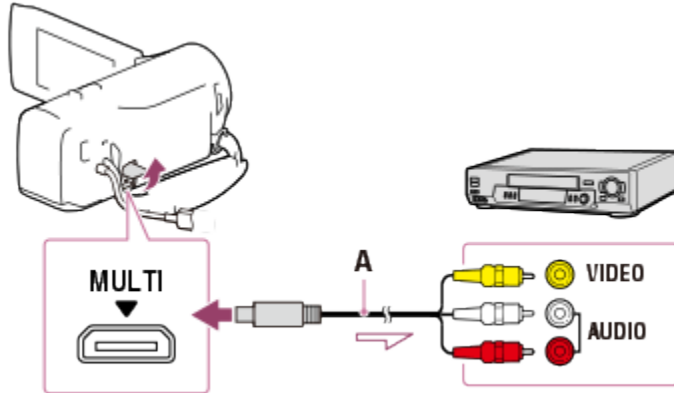

A: AV cable (sold separately)

3. Start playback on this product, and record it on the recording device.
4. When dubbing is finished, stop the recording device, and then this product.

Note

- You cannot copy images to recorders connected with the HDMI cable.
- Since copying is performed via analog data transfer, the image quality may deteriorate.
- Images will be copied with standard definition image quality.
- When you connect a monaural device, connect the yellow plug of an AV cable (sold separately) to the video input jack, and the white (left channel) or the red (right channel) plug to the audio input jack on the device.

Hint

Change the [Data Code] setting if you want to copy the date and time and the camera setting data information.

- Set [TV Type] to [4:3] if the screen size of your display device such as TV is 4:3.

Related Topic

- [Charging the battery pack using the AC Adaptor](#)
- [Data Code](#)
- [TV Type](#)

Notes on use

4-531-544-11(1)

Copyright 2014 Sony Corporation



Digital HD Video Camera Recorder
HDR-CX240/CX240E/PJ240/PJ240E/PJ270/PJ270E/PJ275

What you can do with the Wi-Fi function (models with the Wi-Fi/NFC functions)

Explains what you can do using the Wi-Fi function of this product.

Saving movies and photos to your computer

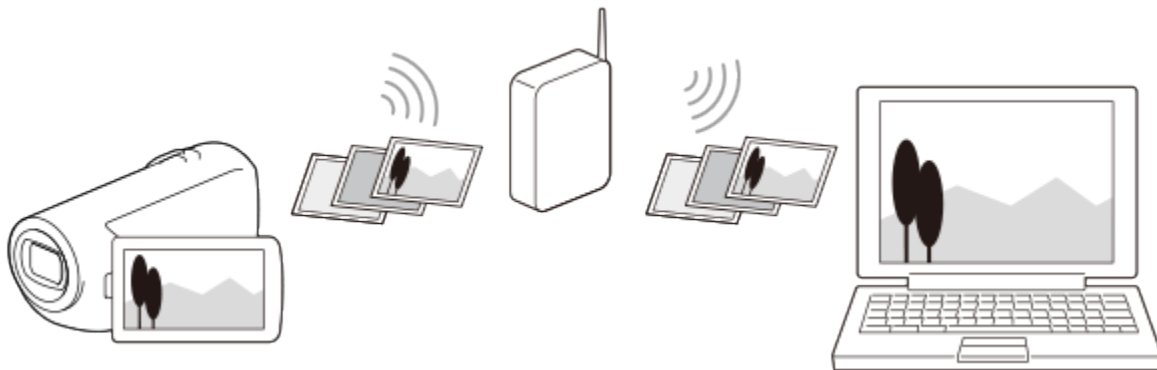

Transferring movies (MP4) and photos to your smartphone or tablet

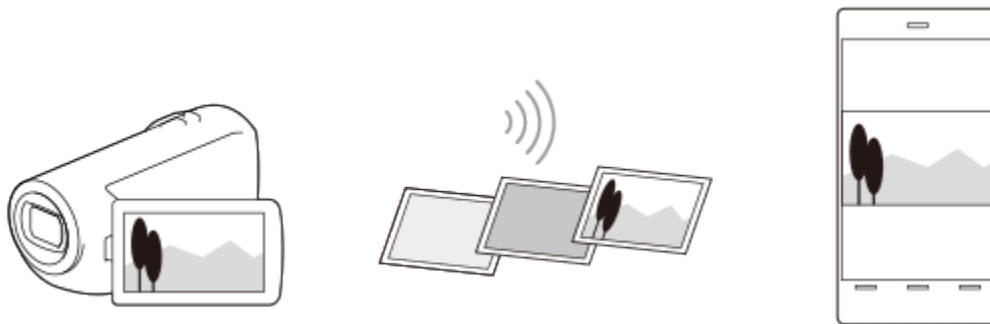

Using your smartphone or tablet as a wireless remote commander

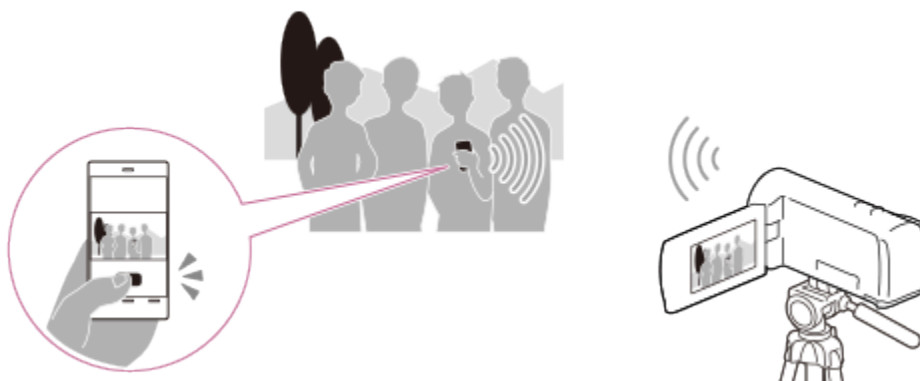

Playing images on a TV

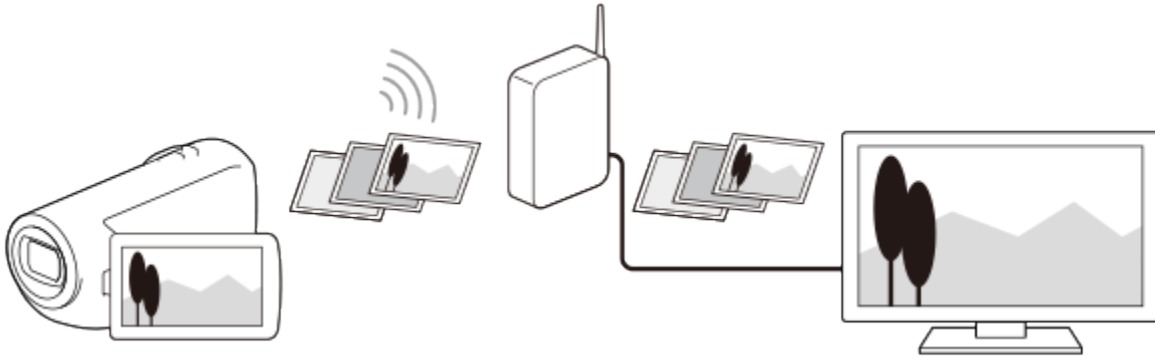

Note

- You cannot use the Wi-Fi function of this product to connect to a public wireless network.
- PlayMemories Mobile is not guaranteed to work on all smartphones and tablets.

Related Topic

- [Send to Computer \(models with the Wi-Fi/NFC functions\)](#)
- [Transferring movies \(MP4\) and photos to your smartphone or tablet \(models with the Wi-Fi/NFC functions\)](#)
- [Transferring movies \(MP4\) and photos to your smartphone or tablet using the NFC function \(NFC one-touch sharing\) \(models with the Wi-Fi/NFC functions\)](#)
- [Using your smartphone or tablet as a wireless remote commander \(models with the Wi-Fi/NFC functions\)](#)
- [Using your smartphone or tablet as a wireless remote commander using the NFC function \(NFC one-touch remote\) \(models with the Wi-Fi/NFC functions\)](#)
- [Playing images on a TV \(View on TV\) \(models with the Wi-Fi/NFC functions\)](#)

Notes on use

4-531-544-11(1)

Copyright 2014 Sony Corporation



Digital HD Video Camera Recorder
HDR-CX240/CX240E/PJ240/PJ240E/PJ270/PJ270E/PJ275

Using your smartphone or tablet as a wireless remote commander (models with the Wi-Fi/NFC functions)

You can operate this product using your smartphone or tablet as a wireless remote commander.

1. Install PlayMemories Mobile on your smartphone.
 - If PlayMemories Mobile is already installed in your smartphone, update the software to the latest version.
2. On the LCD monitor of this product, select **MENU** - [Camera/Mic] - [Shooting Assist] - [Ctrl with Smartphone].
 - The SSID and password are displayed on the LCD monitor of this product. This product is now ready to be operated using your smartphone.



A: SSID

B: Password

3. Start PlayMemories Mobile, then on the smartphone screen, select the SSID displayed on the LCD monitor of this product, and then enter the password displayed on the LCD monitor of this product.
 - Connect to this product using your smartphone.
4. Operate this product using your smartphone.

Note

- The photo size stored on the smartphone is [2M] except when the image size is [S (VGA)].
- Movies are recorded on this product and are not stored on the smartphone.
- The operation methods and display screens for the application are subject to change without notice by future upgrades.
- This application is not guaranteed to work on all smartphones and tablets.

Hint

- For the latest supported OS, refer to the download page of PlayMemories Mobile.

- About the PlayMemories Mobile software (models with the Wi-Fi/NFC functions)
- Connecting to an Android smartphone or tablet (models with the Wi-Fi/NFC functions)
- Connecting to an NFC-enabled smartphone or tablet (models with the Wi-Fi/NFC functions)
- Connecting to an iPhone or iPad (models with the Wi-Fi/NFC functions)

Notes on use

4-531-544-11(1)

Copyright 2014 Sony Corporation



Digital HD Video Camera Recorder
HDR-CX240/CX240E/PJ240/PJ240E/PJ270/PJ270E/PJ275

Using your smartphone or tablet as a wireless remote commander using the NFC function (NFC one-touch remote) (models with the Wi-Fi/NFC functions)

You can operate this product using your NFC-enabled smartphone or tablet as a wireless remote commander.

Note

- Make sure that your smartphone is not in sleep mode and the screen is unlocked in advance.
1. Install PlayMemories Mobile on your smartphone.
 - If PlayMemories Mobile is already installed in your smartphone, update the software to the latest version.
 2. Select [Settings] on the smartphone, then select [More...] and place a checkmark next to [NFC].

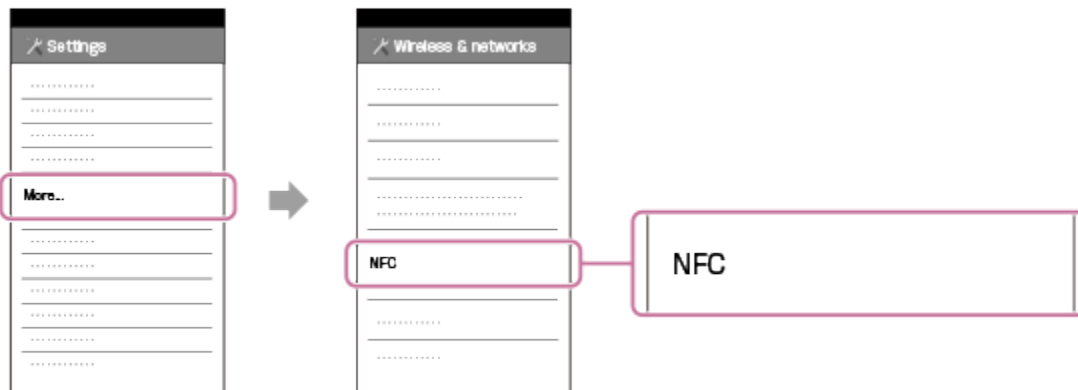

3. Enter the recording mode, and then touch  (N mark) of this product to  (N mark) of your smartphone.

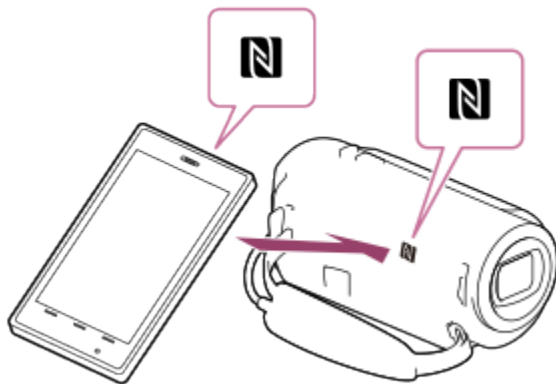

- Make sure that  (N mark) is displayed on the LCD monitor of this product.
- Hold this product and your smartphone together and keep them still for about 1-2 seconds until PlayMemories Mobile starts up on your smartphone.

4. Operate this product using your smartphone.

Note

- The photo size stored on the smartphone is [2M] except when the image size is [4:3 S (VGA)].
- Movies are recorded on this product and are not stored on the smartphone.
- The operation methods and display screens for the application are subject to change without notice by future upgrades.
- This application is not guaranteed to work on all smartphones and tablets.
- If the connections is not made successfully, try the procedures shown in “Connecting to an Android smartphone or tablet.”

Hint

- For the latest supported OS, refer to the download page of PlayMemories Mobile.

Related Topic

- [About the PlayMemories Mobile software \(models with the Wi-Fi/NFC functions\)](#)
- [Connecting to an Android smartphone or tablet \(models with the Wi-Fi/NFC functions\)](#)
- [Connecting to an NFC-enabled smartphone or tablet \(models with the Wi-Fi/NFC functions\)](#)

[Notes on use](#)

4-531-544-11(1)

Copyright 2014 Sony Corporation



Digital HD Video Camera Recorder
HDR-CX240/CX240E/PJ240/PJ240E/PJ270/PJ270E/PJ275

Transferring movies (MP4) and photos to your smartphone or tablet (models with the Wi-Fi/NFC functions)

Transfer images to your smartphone or tablet.

1. Install PlayMemories Mobile on your smartphone.
 - If PlayMemories Mobile is already installed in your smartphone, update the software to the latest version.
2. Press the  button on this product to enter the playback mode.
3. On the LCD monitor of this product, select **MENU** - [Edit/Copy] - [Send to Smartphone] - [Select on This Device].
 - If you select [Select on Smartphone], all images stored in the internal memory of this product (models with the internal memory) or on the memory card are displayed on the smartphone screen.
4. Select the type of image you want to transfer.



5. Select the image you want to transfer, and add  mark, and then select **OK** - **OK**.

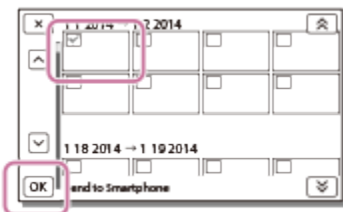

- The SSID and a password are displayed on the LCD monitor of this product. This product is now ready to be connected from your smartphone.



A: SSID

B: Password

6. Start PlayMemories Mobile, then on the smartphone screen, select the SSID displayed on the LCD monitor of this product, and then enter the password displayed on the LCD monitor of this product.
7. The images are transferred from this product to the smartphone.
 - Transferred images will be stored in Gallery/Album on an Android smartphone/tablet or Album on an iPhone/iPad.

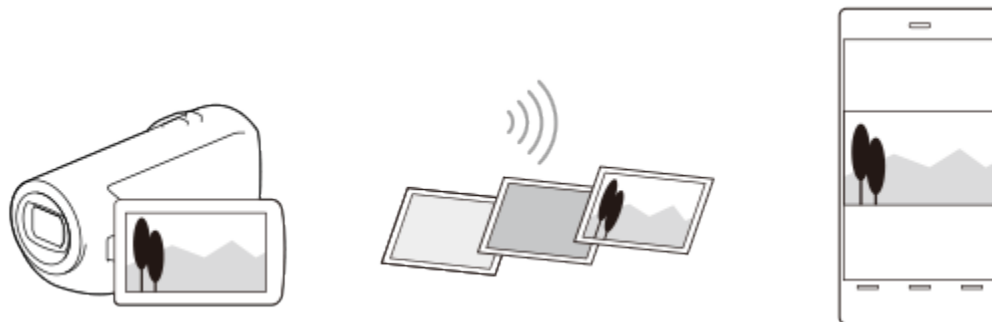
**Note**

- You cannot transfer AVCHD movies.
- [Send to Smartphone] is not available when MP4 movies or still images have not been saved on this product.
- If you want to import images recorded on a memory card, insert the memory card to this product, and then select the memory card in [Media Select] (models with the internal memory).
- This application is not guaranteed to work on all smartphones and tablets.

Hint

- For the latest supported OS, refer to the download page of PlayMemories Mobile.

Related Topic

- [About the PlayMemories Mobile software \(models with the Wi-Fi/NFC functions\)](#)
- [Connecting to an Android smartphone or tablet \(models with the Wi-Fi/NFC functions\)](#)
- [Connecting to an NFC-enabled smartphone or tablet \(models with the Wi-Fi/NFC functions\)](#)
- [Connecting to an iPhone or iPad \(models with the Wi-Fi/NFC functions\)](#)

Notes on use

4-531-544-11(1)

Copyright 2014 Sony Corporation



Digital HD Video Camera Recorder
HDR-CX240/CX240E/PJ240/PJ240E/PJ270/PJ270E/PJ275



Transferring movies (MP4) and photos to your smartphone or tablet using the NFC function (NFC one-touch sharing) (models with the Wi-Fi/NFC functions)

Transfer images to your NFC-enabled Android smartphone or tablet.

Note

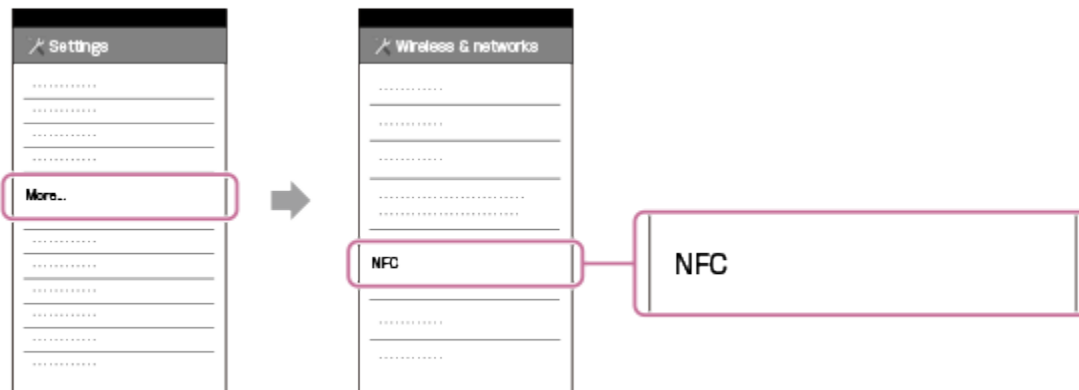
- Make sure that your smartphone is not in sleep mode and the screen is unlocked in advance.
1. Install PlayMemories Mobile on your smartphone.
 - If PlayMemories Mobile is already installed in your smartphone, update the software to the latest version.
 2. Select [Settings] on the smartphone, then select [More...] and place a checkmark next to [NFC].



3. Press the  button on this product to enter the playback mode, and then display the image you want to transfer on the LCD monitor of this product.
4. Touch  (N mark) of this product to  (N mark) of your smartphone.

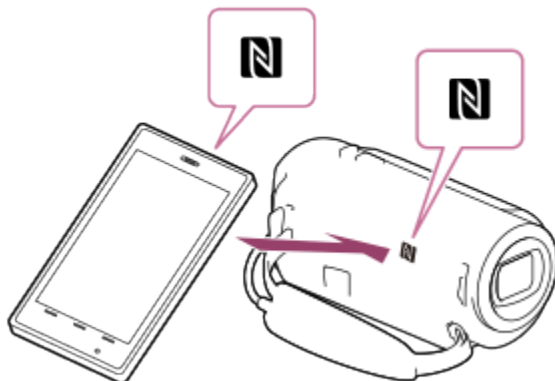

- Hold this product and your smartphone together and keep them still for about 1-2 seconds until PlayMemories Mobile starts up on your smartphone.

Make sure that  (N mark) is displayed on the LCD monitor of this product.

5. The images are transferred from this product to the smartphone.

- Transferred images will be stored in Gallery/Album on an Android smartphone/tablet or Album on an iPhone/iPad.

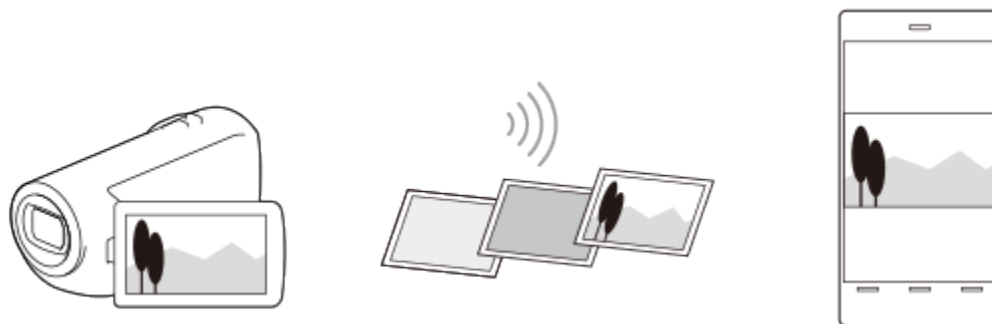

Note

- You cannot transfer AVCHD movies.
- [Send to Smartphone] is not available when MP4 movies or still images have not been saved on this product.
- If you want to import images recorded on a memory card, insert the memory card to this product, and then select the memory card in [Media Select] (models with the internal memory).
- This application is not guaranteed to work on all smartphones and tablets.
- If the connections is not made successfully, try the procedures shown in “Connecting to an Android smartphone or tablet.”

Hint

- For the latest supported OS, refer to the download page of PlayMemories Mobile.

Related Topic

- [About the PlayMemories Mobile software \(models with the Wi-Fi/NFC functions\)](#)
- [Connecting to an NFC-enabled smartphone or tablet \(models with the Wi-Fi/NFC functions\)](#)
- [Connecting to an Android smartphone or tablet \(models with the Wi-Fi/NFC functions\)](#)

Notes on use

4-531-544-11(1)

Copyright 2014 Sony Corporation



Digital HD Video Camera Recorder
HDR-CX240/CX240E/PJ240/PJ240E/PJ270/PJ270E/PJ275

Send to Computer (models with the Wi-Fi/NFC functions)

You can transfer and save movies and photos to your computer.

1. Install the software on your computer.

For Windows: PlayMemories Home

www.sony.net/pm/

For Mac: Wireless Auto Import

www.sony.co.jp/imsoft/Mac/

- If connecting this product to your computer for the first time after installing the software, set [USB Connect Setting] to [Auto] or [MTP] on this product, and then connect this product to your computer with the Built-in USB Cable.
- If the software is already installed in your computer, update the software to the latest version.

2. Connect this product to the wireless network access point.

- If your access point does not support the WPS push button, refer to [Access point settings].
- If your access point supports the WPS push button, refer to [WPS Push].
- Settings for steps 1 and 2 are required only the first time.

3. Press the  button on this product to enter the playback mode.

4. On the LCD monitor of this product, select  - [Edit/Copy] - [Send to Computer].

- Images are automatically transferred to and saved on the computer.
- Only newly recorded images are transferred.

Note

- You must turn on the computer to execute [Send to Computer].
- Depending on the settings of the application on the computer, this product may turn off automatically after saving images.
- If you want to import images recorded on a memory card, insert the memory card to this product in advance (models with the internal memory).
- Importing movies and multiple still images may take time.

Related Topic

- [Access point settings \(HDR-PJ275\)](#)
- [WPS Push \(HDR-PJ275\)](#)





Digital HD Video Camera Recorder
HDR-CX240/CX240E/PJ240/PJ240E/PJ270/PJ270E/PJ275

Playing images on a TV (View on TV) (models with the Wi-Fi/NFC functions)

You can view images on your TV connected to the network by transferring images from this product without connecting this product and TV with a cable.

Operations may be required on your TV before playing depending on the TV you use. Refer to the instruction manuals of the TV as well.

1. Connect this product to a wireless network access point.
 - If your access point does not support the WPS push button, refer to [Access point settings].
 - If your access point supports the WPS push button, refer to [WPS Push].
 - Step 1 can be skipped from the second time.
2. Press the  button on this product to enter the playback mode.
3. Select  - [Edit/Copy] - [View on TV] - the type of image you want to transfer.
4. Play a movie or a photo on the TV.

Note

- This function is available with the DLNA player compatible TVs.
- You can view images only on TVs that are compatible with the network function (including wired network).
- It may take time until the images are played on the TV.
- This function is not available when using an access point without a security setting (WEP/WPA/WPA2) to protect from prying eyes.
- Select the access point you registered with this product when connecting your TV.
- To enjoy viewing movies comfortably, use a wired network connection for your TV. Depending on the wireless network environment, movies may not be played smoothly.
- Depending on the settings of the recorded movie, it may not play smoothly.

Related Topic

- [Access point settings \(HDR-PJ275\)](#)
- [WPS Push \(HDR-PJ275\)](#)



Digital HD Video Camera Recorder
HDR-CX240/CX240E/PJ240/PJ240E/PJ270/PJ270E/PJ275

Connecting to an Android smartphone or tablet (models with the Wi-Fi/NFC functions)

Shows how to connect this product to your Android smartphone or tablet. Display the SSID and password in advance by selecting [Send to Smartphone] or [Ctrl with Smartphone] on this product.

1. Start up PlayMemories Mobile on the smartphone.



2. Select the SSID displayed on this product.



3. Enter the password displayed on this product.



Related Topic

- [About the PlayMemories Mobile software \(models with the Wi-Fi/NFC functions\)](#)
- [Transferring movies \(MP4\) and photos to your smartphone or tablet \(models with the Wi-Fi/NFC functions\)](#)
- [Using your smartphone or tablet as a wireless remote commander \(models with the Wi-Fi/NFC functions\)](#)

Notes on use

4-531-544-11(1)

Copyright 2014 Sony Corporation



Digital HD Video Camera Recorder
HDR-CX240/CX240E/PJ240/PJ240E/PJ270/PJ270E/PJ275

Connecting to an iPhone or iPad (models with the Wi-Fi/NFC functions)

Shows how to connect this product to your iPhone or iPad. Display the SSID and password in advance by selecting [Send to Smartphone] or [Ctrl with Smartphone] on this product.

1. Open the settings menu.



2. Select Wi-Fi.

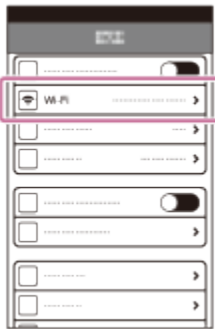

3. Select the SSID displayed on this product.



4. Enter the password displayed on this product.



5. Confirm that the SSID displayed on this product is selected.

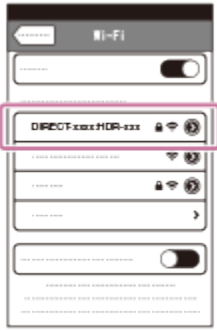

6. Go back to Home and start up PlayMemories Mobile.

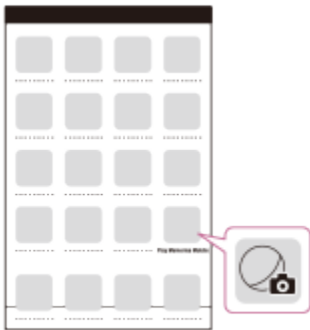

Related Topic

- [About the PlayMemories Mobile software \(models with the Wi-Fi/NFC functions\)](#)
- [Transferring movies \(MP4\) and photos to your smartphone or tablet \(models with the Wi-Fi/NFC functions\)](#)
- [Using your smartphone or tablet as a wireless remote commander \(models with the Wi-Fi/NFC functions\)](#)

Notes on use

4-531-544-11(1)

Copyright 2014 Sony Corporation





Digital HD Video Camera Recorder
HDR-CX240/CX240E/PJ240/PJ240E/PJ270/PJ270E/PJ275

Connecting to an NFC-enabled smartphone or tablet (models with the Wi-Fi/NFC functions)

You can easily connect this product to your NFC-enabled Android smartphone or tablet.

Note

- Make sure that your smartphone is not in sleep mode and the screen is unlocked in advance.
1. Touch  (N mark) of this product to  (N mark) of your smartphone.
 - Make sure that  (N mark) is displayed on the LCD monitor of this product.

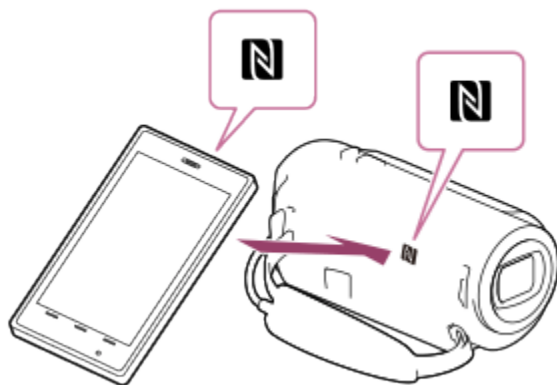

What you can do with the NFC connection

Operations available when you touch this product to an NFC-enabled smartphone differs depending on the status of this product.

When this product is in movie/photo recording mode

[Ctrl with Smartphone] starts up.

When images are being played back on this product

[Send to Smartphone] starts up and images being played back are transferred.

Note

- To use the one-touch functions of this product, an NFC-enabled smartphone or tablet is required.
- NFC (Near Field Communication) is an international standard for short-range wireless communication technology.
- If the connection is not made successfully, try the procedures shown in “Connecting to an Android smartphone or tablet.”

Related Topic

- [About the PlayMemories Mobile software \(models with the Wi-Fi/NFC functions\)](#)

- Transferring movies (MP4) and photos to your smartphone or tablet (models with the Wi-Fi/NFC functions)
- Using your smartphone or tablet as a wireless remote commander (models with the Wi-Fi/NFC functions)

Notes on use

4-531-544-11(1)

Copyright 2014 Sony Corporation



Digital HD Video Camera Recorder
HDR-CX240/CX240E/PJ240/PJ240E/PJ270/PJ270E/PJ275

About the PlayMemories Mobile software (models with the Wi-Fi/NFC functions)

To perform operations such as [Ctrl with Smartphone] and [Send to Smartphone], the PlayMemories Mobile application for smartphone is required. Install the application from the applications store for your smartphone. If PlayMemories Mobile is already installed in your smartphone, update the application to the latest version. For details on PlayMemories Mobile, visit the PlayMemories Mobile support page (www.sony.net/pmm/).

Notes on use

4-531-544-11(1)

Copyright 2014 Sony Corporation



Digital HD Video Camera Recorder
HDR-CX240/CX240E/PJ240/PJ240E/PJ270/PJ270E/PJ275

Setting up menu items

This product has various menu items under each of 6 menu categories.

1. Select **MENU**.



2. Select a category.

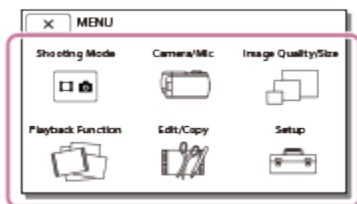

3. Select your desired menu item.



Note

- Select **X** to finish setting the menu or to return to the previous screen.

To find a menu item quickly

The [Camera/Mic] and [Setup] menus have sub-categories. Select the sub-category icon so that you can select your desired menu item.

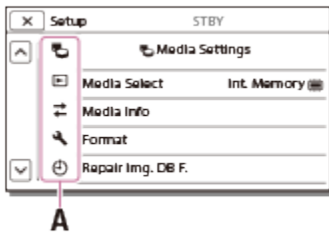

A: Sub-category icons

When you cannot select a menu item

Some menu items or settings are not available, depending on the settings of this product. When you select grayed out menu items or settings, this product displays the reason why you cannot select the menu item.

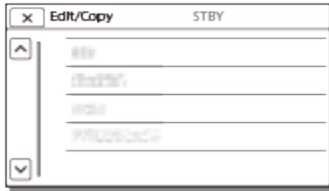

Notes on use

4-531-544-11(1)

Copyright 2014 Sony Corporation



Digital HD Video Camera Recorder
HDR-CX240/CX240E/PJ240/PJ240E/PJ270/PJ270E/PJ275

How to use the keyboard (HDR-PJ275)

A keyboard is displayed on the LCD monitor when text needs to be entered.

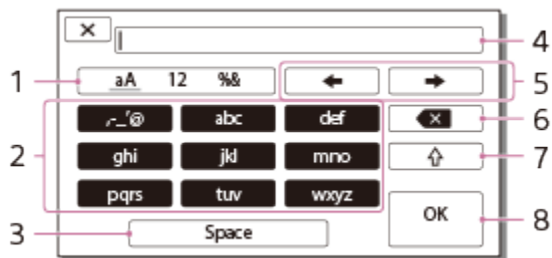

1. Switch character types.

Each time you switch character types, character types are switched among alphabet letters, numerals and symbols.

2. Keyboard

Each time you select and enter any character, the character that you enter will be displayed in turn.

For example: If you want to enter “abd”

Select [abc] and press it once to display “a,” and then enter “a” with . To enter “b” and “d,” press [abc] twice to display “b,” and then press [def] once to display “d.”

3. Space

Enters a space.

4. Input box

The characters you entered are displayed. ◀ indicates the limit to text length.

5. Move cursor

Moves the cursor in the input box to the right or left.

6. Delete

Deletes the character preceding the cursor.

7. 

Switches the next character to a capital or small letter.

8. Fix

Finalizes the entry.

To cancel text entry, select .

Notes on use



Digital HD Video Camera Recorder
HDR-CX240/CX240E/PJ240/PJ240E/PJ270/PJ270E/PJ275

Movie

You can select the movie recording mode.

1. **MENU** - [Shooting Mode] - [Movie].

Related Topic

- [Recording movies](#)

Notes on use

4-531-544-11(1)

Copyright 2014 Sony Corporation



Digital HD Video Camera Recorder
HDR-CX240/CX240E/PJ240/PJ240E/PJ270/PJ270E/PJ275

Photo

You can select the photo shooting mode.

1. **MENU** - [Shooting Mode] - [Photo].

Related Topic

● [Shooting photos](#)

Notes on use

4-531-544-11(1)

Copyright 2014 Sony Corporation



Digital HD Video Camera Recorder
HDR-CX240/CX240E/PJ240/PJ240E/PJ270/PJ270E/PJ275

White Balance

You can adjust the color balance to the recording environment.

1. - [Camera/Mic] - [Manual Settings] - [White Balance] - desired setting.

Descriptions of menu items

(Auto) (default setting):

The white balance is adjusted automatically.

If you have changed the battery pack while [Auto] was selected, or taken this product outdoors after inside use (or vice versa), aim this product at a nearby white object for about 10 seconds for better color balance adjustment.

(Outdoor):

The white balance is appropriately adjusted for the following recording conditions:

- Outdoors
- Night views, neon signs and fireworks
- Sunrise or sunset
- Under daylight fluorescent lamps

(Indoor):

The white balance is appropriately adjusted for the following recording conditions:

- Indoors
- At party scenes or studios where the lighting conditions change quickly
- Under video lamps in a studio, or under sodium lamps or incandescent-like color lamps

(One Push):

The white balance will be adjusted according to the ambient light.

1. Select .
2. Keep framing white object such as a piece of paper, to fill the LCD monitor under the same lightning conditions as you will shoot the subject.
3. Select .

If the lighting conditions changed by bringing this product outdoors from inside the house, or vice versa, you need to redo the [One Push] procedure to readjust the white balance.

Note

- Set [White Balance] to [Auto] or adjust the color in [One Push] under white or cool white fluorescent lamps.
- While you are recording a movie, (One Push) cannot be set.
- If you set [White Balance], [Scene Selection] is set to [Auto].



Digital HD Video Camera Recorder
HDR-CX240/CX240E/PJ240/PJ240E/PJ270/PJ270E/PJ275

Exposure

You can fix the brightness of an image manually. Adjust the brightness when the subject is too bright or too dark.

1. - [Camera/Mic] - [ Manual Settings] - [Exposure] - desired setting.

Descriptions of menu items

Auto (default setting):

The exposure is adjusted automatically.

Manual:

Select if the subject is white or the backlight is bright, or select if the subject is black or the light is dim.

Notes on use

4-531-544-11(1)

Copyright 2014 Sony Corporation



Digital HD Video Camera Recorder
HDR-CX240/CX240E/PJ240/PJ240E/PJ270/PJ270E/PJ275

Focus

You can adjust the focus manually. You can select this function also when you want to focus on a certain subject intentionally.

1. [MENU] - [Camera/Mic] - [Manual Settings] - [Focus] - desired setting.

Descriptions of menu items

Auto (default setting):

The focus is adjusted automatically.

Manual:

appears.

Adjust the focus using (nearby subject) or (distant subject). appears when the focus cannot be adjusted any closer, and appears when the focus cannot be adjusted farther away.

Note

- The minimum possible distance between this product and subject while maintaining sharp focus is about 1 cm (about 13/32 in.) for wide angle and about 80 cm (about 31 1/2 in.) for telephoto.

Hint

- It is easier to focus on the subject by moving the power zoom lever towards T (telephoto) to adjust the focus, then towards W (wide angle) to adjust the zoom for recording. When you want to record a subject at close range, move the power zoom lever to W (wide angle), then adjust the focus.
- This product displays the focal distance information for a few seconds when [Focus] is set to [Manual] or when you set the focus manually. You can use this information as a guide when the subject is dark and focus adjustment is difficult.

Notes on use

4-531-544-11(1)

Copyright 2014 Sony Corporation



Digital HD Video Camera Recorder
HDR-CX240/CX240E/PJ240/PJ240E/PJ270/PJ270E/PJ275

Low Lux

You can record bright color images, even in dim light.

1. **MENU** - [Camera/Mic] - [**M** Manual Settings] - [Low Lux] - desired setting.

Descriptions of menu items

Off (default setting):

The Low Lux function is not used.

On (🔦):

The Low Lux function is used.

Notes on use

4-531-544-11(1)

Copyright 2014 Sony Corporation



Digital HD Video Camera Recorder
HDR-CX240/CX240E/PJ240/PJ240E/PJ270/PJ270E/PJ275

Scene Selection

You can record images effectively in various situations.

1. [MENU] - [Camera/Mic] - [ Camera Settings] - [Scene Selection] - desired setting.

Descriptions of menu items

 **(Auto)(default setting):**

Adjusts image quality automatically.

 **(Night Scene)(*):**

Using a tripod (sold separately) allows you to shoot beautiful night scenes.



 **(Sunrise&Sunset)(*):**

Reproduces the atmosphere of scenes such as sunsets or sunrises.



 **(Fireworks)(*):**

Takes spectacular shots of fireworks.



 **(Landscape)(*):**

Shoots distant subjects clearly. This setting also prevents this product from focusing on glass or metal mesh in windows between this product and the subject.



 **(Portrait):**

Brings out the subject such as people or flowers while creating a soft background.



 **(Spotlight):**

Prevents people's faces from appearing excessively white when subjects are lit by strong light.



 **(Beach):**

Takes the vivid blue of the ocean or a lake.



 **(Snow):**

Takes bright pictures of a white landscape.



* Adjusted to focus on subjects farther away only.

Note

- If you set [Scene Selection], the following settings are canceled.
 - _ White Balance



Digital HD Video Camera Recorder
HDR-CX240/CX240E/PJ240/PJ240E/PJ270/PJ270E/PJ275

Picture Effect

Allows you to shoot more impressive images by selecting the desired effect.

1. **MENU** - [Camera/Mic] -  Camera Settings] - [Picture Effect] - desired setting.

Descriptions of menu items

Off (default setting):

Does not use the Picture Effect.

(Toy Camera):

Allows you to shoot an image having a unique color tone with its surrounding colors dark. Select the effect you want with [OPTION].

(Pop Color):

Allows you to shoot a pop art-like colorful image with emphasis on the color tone.

(Posterization):

Creates a high contrast, abstract look by heavily emphasizing primary colors, or in black and white. Select the effect you want with [OPTION].

(Retro Photo):

Creates the look of an aged photo with sepia color tones and faded contrast.

(Soft High-key):

Allows you to shoot soft, clear images with an emphasis on brightness.

(Partial Color):

Allows you to shoot an image that makes a strong impression by leaving a specified color on portions of a monochrome image. Select the effect you want with [OPTION].

(High Contrast Mono.):

Creates an intense, high-contrast image in black and white.

Note

- When you select a [Picture Effect] item, the following functions are not available.
 - Recording photos in the movie recording mode
 - Some other functions



Digital HD Video Camera Recorder
HDR-CX240/CX240E/PJ240/PJ240E/PJ270/PJ270E/PJ275

Fader

You can record a transition with the following effects adding to the interval between scenes. Select the desired effect in [STBY] (to fading in) or [REC] (to fading out) mode.

1. [MENU] - [Camera/Mic] - [Camera Settings] - [Fader] - desired setting.

Descriptions of menu items

Off (default setting):

Does not use an effect.

White Fader(**W**):

Fades in/out with the white effect.



A: Out

B: In

Black Fader(**B**):

Fades in/out with the black effect.

Images recorded using the [Black Fader] effect may appear dark on the index screen.



A: Out

B: In

Note

- When you press START/STOP, the setting is cleared.

Notes on use



Digital HD Video Camera Recorder
HDR-CX240/CX240E/PJ240/PJ240E/PJ270/PJ270E/PJ275

Self-Timer

Press PHOTO to start the count down. A photo is recorded after about 10 seconds.

1. [MENU] - [Camera/Mic] - [ Camera Settings] - [ Self-Timer] - desired setting.

Descriptions of menu items

Off (default setting):

Cancels the self-timer.

On ():

Starts the self-timer recording. To cancel the recording, select  .

Notes on use

4-531-544-11(1)

Copyright 2014 Sony Corporation



Digital HD Video Camera Recorder
HDR-CX240/CX240E/PJ240/PJ240E/PJ270/PJ270E/PJ275

SteadyShot (Movie)

You can compensate for camera shake.

1. - [Camera/Mic] - Camera Settings] - SteadyShot] - desired setting.

Descriptions of menu items

Active (default setting):

Records a movie using a more effective SteadyShot function.

Standard:

This product reduces camera shake using the SteadyShot function in wide-angle shooting.

Off ():

This product does not use the SteadyShot function.

Note

- The angle of view will be changed after changing the settings of the SteadyShot] function.
- The zoom magnification varies depending on the SteadyShot] setting.

Related Topic

[Zoom magnifications](#)

Notes on use

4-531-544-11(1)

Copyright 2014 Sony Corporation



Digital HD Video Camera Recorder
HDR-CX240/CX240E/PJ240/PJ240E/PJ270/PJ270E/PJ275

Digital Zoom

You can select the maximum zoom level. Note that the image quality decreases when you use the digital zoom.

1. [MENU] - [Camera/Mic] - [ Camera Settings] - [Digital Zoom] - desired setting.

Descriptions of menu items

Off (default setting):

Digital zoom cannot be used.

320:

Up to 320 zoom is performed digitally.

Notes on use

4-531-544-11(1)

Copyright 2014 Sony Corporation



Digital HD Video Camera Recorder
HDR-CX240/CX240E/PJ240/PJ240E/PJ270/PJ270E/PJ275

Auto Back Light

This product adjusts the exposure for backlit subjects automatically.

1. **MENU** - [Camera/Mic] - [ Camera Settings] - [Auto Back Light] - desired setting.

Descriptions of menu items

On (default setting):

The exposure for backlit subjects is adjusted automatically.

Off:

Does not adjust the exposure for backlit subjects.

Notes on use

4-531-544-11(1)

Copyright 2014 Sony Corporation



Digital HD Video Camera Recorder
HDR-CX240/CX240E/PJ240/PJ240E/PJ270/PJ270E/PJ275

Face Detection

You can set this product to detect a face automatically. This product adjusts the focus/color/exposure automatically for the face of the selected subject.

1. **MENU** - [Camera/Mic] - [Face] - [Face Detection] - desired setting.

Descriptions of menu items

Auto (default setting):

Detects faces.

Off (OFF):

Does not detect faces.

Note

- Faces may not be detected depending on recording conditions.

Hint

- Recording conditions for better face detection performance are as follows.
 - _ Shoot in a sufficiently bright place.
 - _ The subject is not wearing glasses, a hat or mask.
 - _ The subject faces directly towards the camera.

Related Topic

[Smile Shutter](#)

Notes on use

4-531-544-11(1)

Copyright 2014 Sony Corporation



Digital HD Video Camera Recorder
HDR-CX240/CX240E/PJ240/PJ240E/PJ270/PJ270E/PJ275

Smile Shutter

The shutter is released automatically when this product detects a smile. If you do not want to take photos automatically, select [Off].

1. **MENU** - [Camera/Mic] - [Face] - [Smile Shutter] - desired setting.

Descriptions of menu items

Dual Capture ():

Only during movie recording, the shutter is released automatically, when this product detects a smile.

Always On ():

The shutter is released when this product detects a smile whenever this product is in recording mode.

Off (default setting):

Smiles are not detected, so photos are not recorded automatically.

Note

- Smiles may not be detected depending on recording conditions, subject conditions, and the setting of this product.

Notes on use

4-531-544-11(1)

Copyright 2014 Sony Corporation



Digital HD Video Camera Recorder
HDR-CX240/CX240E/PJ240/PJ240E/PJ270/PJ270E/PJ275

Smile Sensitivity

Sets the smile detection sensitivity for using the Smile Shutter function.

1. [MENU] - [Camera/Mic] - [Face] - [Smile Sensitivity] - desired setting.

Descriptions of menu items

Big Smile:

Detects a big smile.

Normal Smile (default setting):

Detects a normal smile.

Slight Smile:

Detects even a slight smile.

Notes on use

4-531-544-11(1)

Copyright 2014 Sony Corporation



Digital HD Video Camera Recorder
HDR-CX240/CX240E/PJ240/PJ240E/PJ270/PJ270E/PJ275

Blt-in Zoom Mic

You can record a movie with vivid sound appropriate to the zoom position.

1. **[MENU]** - [Camera/Mic] - [ Microphone] - [Blt-in Zoom Mic] - desired setting.

Descriptions of menu items

Off (default setting):

The microphone does not record sound following zooming in or out.

On ():

The microphone records sound following zooming in or out.

Notes on use

4-531-544-11(1)

Copyright 2014 Sony Corporation



Digital HD Video Camera Recorder
HDR-CX240/CX240E/PJ240/PJ240E/PJ270/PJ270E/PJ275

Wind Noise Reduct.

This product records a movie with less wind noise input from the built-in microphone.

1. **MENU** - [Camera/Mic] - [Microphone] - [Wind Noise Reduct.] - desired setting.

Descriptions of menu items

Off (default setting):

Disables wind noise reduction.

On ():

Enables wind noise reduction cutting the low-range wind noise.

Notes on use

4-531-544-11(1)

Copyright 2014 Sony Corporation



Digital HD Video Camera Recorder
HDR-CX240/CX240E/PJ240/PJ240E/PJ270/PJ270E/PJ275

Micref Level

You can select the microphone level for recording sound.

1. **MENU** - [Camera/Mic] - [Microphone] - [Micref Level] - desired setting.

Descriptions of menu items

Normal (default setting):

Records various ambient sounds, converting them into the appropriate level.

Low ():

Records ambient sound faithfully. Select [Low] when you want to record an exciting and powerful sound in a concert hall, etc. (This setting is not suitable for recording conversations.)

Notes on use

4-531-544-11(1)

Copyright 2014 Sony Corporation



Digital HD Video Camera Recorder
HDR-CX240/CX240E/PJ240/PJ240E/PJ270/PJ270E/PJ275

Ctrl with Smartphone (HDR-PJ275)

You can use your smartphone as a wireless remote commander.

1. **MENU** - [Camera/Mic] - [ Shooting Assist] - [Ctrl with Smartphone].

Related Topic

- [Using your smartphone or tablet as a wireless remote commander \(models with the Wi-Fi/NFC functions\)](#)
- [Using your smartphone or tablet as a wireless remote commander using the NFC function \(NFC one-touch remote\) \(models with the Wi-Fi/NFC functions\)](#)

Notes on use

4-531-544-11(1)

Copyright 2014 Sony Corporation



Digital HD Video Camera Recorder
HDR-CX240/CX240E/PJ240/PJ240E/PJ270/PJ270E/PJ275

My Button

You can assign functions that you frequently use when recording to one of the My Buttons.

1. **[MENU]** - [Camera/Mic] - [Shooting Assist] - [My Button].
2. Select the menu item that you want to assign to a My Button using **[^]** / **[v]**.

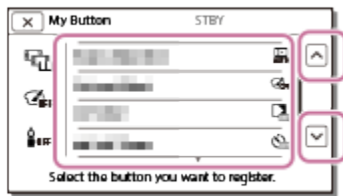

3. Select one of the My Buttons to which the menu item will be assigned.



4. Select **[OK]**.

Notes on use

4-531-544-11(1)

Copyright 2014 Sony Corporation



Digital HD Video Camera Recorder
HDR-CX240/CX240E/PJ240/PJ240E/PJ270/PJ270E/PJ275

Grid Line

You can display the lines and check that the subject is horizontal or vertical.

1. **MENU** - [Camera/Mic] - [Shooting Assist] - [Grid Line] - desired setting.

Descriptions of menu items

Off (default setting):

Does not display the grid lines.

On:

Displays the grid lines.

Hint

- Positioning the subject at the cross point of the grid lines makes a balanced composition.
- The lines is not recorded.
- The outer frame of grid lines shows the display area of a TV which is not compatible with full pixel display.

Notes on use

4-531-544-11(1)

Copyright 2014 Sony Corporation



Digital HD Video Camera Recorder
HDR-CX240/CX240E/PJ240/PJ240E/PJ270/PJ270E/PJ275

Display Setting

You can set the duration of displaying the icons or indicators on the LCD monitor while recording.

1. **MENU** - [Camera/Mic] - [Shooting Assist] - [Display Setting] - desired setting.

Descriptions of menu items

Auto (default setting):

Displays for about 3 seconds.

On:

Always displays.

Note

- You cannot change the setting of the icons or indicators on the LCD monitor while in playback mode.

Notes on use

4-531-544-11(1)

Copyright 2014 Sony Corporation



Digital HD Video Camera Recorder
HDR-CX240/CX240E/PJ240/PJ240E/PJ270/PJ270E/PJ275

REC Mode

You can select your desired image quality for AVCHD movies. The recording time or the type of media device to which the images can be copied may differ, depending on the movie quality selected.

1. **MENU** - [Image Quality/Size] - [REC Mode] - desired setting.

Descriptions of menu items

Highest Quality **FX**:

Records a movie in the highest quality possible for this product (when in 60i (*)/50i (**)).

High Quality **FH**:

Records a higher quality movie (when in 60i (*)/50i (**)).

Standard **HQ**:

Records a standard quality movie (when in 60i (*)/50i (**)).

Long Time **LP**:

Records a long movie (when in 60i (*)/50i (**)).

60p Quality **PS** (*)/50p Quality **PS** (**)

Records a movie in 60p (*)/50p (**).

*Models with the NTSC color system

**Models with the PAL color system

Hint

- Types of media that images can be saved on will depend on the image quality selected.

– 60p Quality **PS** (*)/50p Quality **PS** (**)/Highest Quality **FX**:

Blu-ray discs

– High Quality **FH**/Standard **HQ**/Long Time **LP**:

Blu-ray discs, AVCHD recording discs

*Models with the NTSC color system: [60p Quality **PS**] can be set only when the [Frame Rate] is set to [60p].

Models with the PAL color system: [50p Quality **PS] can be set only when the [Frame Rate] is set to [50p].

Related Topic

● [Frame Rate](#)



Digital HD Video Camera Recorder
HDR-CX240/CX240E/PJ240/PJ240E/PJ270/PJ270E/PJ275

Frame Rate

You can select the frame rate to be used to record AVCHD movies. Using 60i(*) or 50i(**) is recommended for standard recording. Set [Frame Rate] first, before setting [REC Mode].

1. [MENU] - [Image Quality/Size] - [Frame Rate] - desired setting.

Descriptions of menu items

60i(*)/50i(**) (default setting):

This is an ordinary setting for recording.

60p(*)/50p(**):

You can record movies with a volume of data twice that of 60i(*) or 50i(**) per unit time. When you play a movie recorded with this setting on a TV, the TV must be compatible with 60p(*) or 50p(**) movie playback and you have to set [HDMI Resolution] to 1080p.

*Models with the NTSC color system

**Models with the PAL color system

Note

- The media that the recorded images can be saved on will depend on the recording mode that has been set during recording.

Related Topic

● [REC Mode](#)

Notes on use

4-531-544-11(1)

Copyright 2014 Sony Corporation



Digital HD Video Camera Recorder
HDR-CX240/CX240E/PJ240/PJ240E/PJ270/PJ270E/PJ275

Dual Video REC

You can set the dual recording mode (recording an MP4 movie during movie recording) to on or off.

1. **MENU** - [Image Quality/Size] - [Dual Video REC] - desired setting.

Descriptions of menu items

On (default setting):

Records an MP4 movie while recording an HD movie.

Off:

Does not record an MP4 movie while recording an HD movie.

Note

- When [**REC Mode**] is set to [60p Quality **PS** (models with the NTSC color system)]/[50p Quality **PS** (models with the PAL color system)] , [Dual Video REC] will be set to [Off].

Notes on use

4-531-544-11(1)

Copyright 2014 Sony Corporation



Digital HD Video Camera Recorder
HDR-CX240/CX240E/PJ240/PJ240E/PJ270/PJ270E/PJ275

Image Size

You can select a size for the photos you are going to shoot. The number of photos you can shoot differs, depending on the image size selected.

1. **MENU** - [Image Quality/Size] - [ Image Size] - desired setting.

16:9 L (9.2M)

4:3 L (6.9M)

16:9 S (2.1M)

4:3 S (VGA)

Note

- The image size selected with this setting also is applied to photos taken by the Dual Capture function.

Notes on use

4-531-544-11(1)

Copyright 2014 Sony Corporation



Digital HD Video Camera Recorder
HDR-CX240/CX240E/PJ240/PJ240E/PJ270/PJ270E/PJ275

Event View

You can play back recorded images by date of recording (Event View).

1. **MENU** - [Playback Function] - [Event View].

Related Topic

- [Playing movies and photos from the Event View screen](#)

Notes on use

4-531-544-11(1)

Copyright 2014 Sony Corporation



Digital HD Video Camera Recorder
HDR-CX240/CX240E/PJ240/PJ240E/PJ270/PJ270E/PJ275

Scenario

You can view Highlight Scenario that you have saved.

1.  - [Playback Function] - [ Scenario].

Related Topic

- [Playing back a saved scenario](#)

Notes on use

4-531-544-11(1)



Copyright 2014 Sony Corporation



Digital HD Video Camera Recorder
HDR-CX240/CX240E/PJ240/PJ240E/PJ270/PJ270E/PJ275

Send to Smartphone (HDR-PJ275)

Transfer images recorded with this product to your smartphone.

1. Press the  button on this product to enter the playback mode.
2.  - [Edit/Copy] - [Send to Smartphone].

Related Topic

- [Transferring movies \(MP4\) and photos to your smartphone or tablet \(models with the Wi-Fi/NFC functions\)](#)
- [Transferring movies \(MP4\) and photos to your smartphone or tablet using the NFC function \(NFC one-touch sharing\) \(models with the Wi-Fi/NFC functions\)](#)

Notes on use

4-531-544-11(1)



Copyright 2014 Sony Corporation



Digital HD Video Camera Recorder
HDR-CX240/CX240E/PJ240/PJ240E/PJ270/PJ270E/PJ275

View on TV (HDR-PJ275)

You can view images on your TV that is compatible with the network function by transferring images from this product without connecting this product and TV with a cable. Operations may be required on your TV before playing depending on the TV you use. For details, refer to the instruction manuals of the TV.

1. Press  on this product to enter the playback mode.
2.  - [Edit/Copy] - [View on TV].

Related Topic

- [Playing images on a TV \(View on TV\) \(models with the Wi-Fi/NFC functions\)](#)

Notes on use

4-531-544-11(1)



Copyright 2014 Sony Corporation



Digital HD Video Camera Recorder
HDR-CX240/CX240E/PJ240/PJ240E/PJ270/PJ270E/PJ275

Send to Computer (HDR-PJ275)

Transfer images recorded with this product to your computer.

1. Press the  button on this product to enter the playback mode.
2.  - [Edit/Copy] - [Send to Computer].

Related Topic

- [Send to Computer \(models with the Wi-Fi/NFC functions\)](#)

Notes on use

4-531-544-11(1)



Copyright 2014 Sony Corporation



Digital HD Video Camera Recorder
HDR-CX240/CX240E/PJ240/PJ240E/PJ270/PJ270E/PJ275



Delete

You can delete unnecessary images.



1. Press the  button on this product to enter the playback mode.
2. On the Event View screen, select , and then select the movie format you want to delete.
3.  - [Edit/Copy]/[Edit] - [Delete] - desired setting.

Descriptions of menu items



Multiple Images:

You can select images to be deleted. Select the type of image you want to delete, then add  to the desired images, and then select .

All In Event:

You can delete all images in the selected date at one time. Select the date you want to delete using  / , and then select .

Related Topic

-  [Deleting the selected images](#)
-  [Deleting by date](#)

Notes on use

4-531-544-11(1)

Copyright 2014 Sony Corporation



Digital HD Video Camera Recorder
HDR-CX240/CX240E/PJ240/PJ240E/PJ270/PJ270E/PJ275

Protect

Protect movies and photos to avoid deleting them by mistake. will be displayed on the protected images.

1. Press the button on this product to enter the playback mode.
2. On the Event View screen, select , and then select the movie format you want to protect.
3. - [Edit/Copy]/[Edit] - [Protect] - desired setting.

Descriptions of menu items

Multiple Images:

You can select images to be protected. Select the type of image you want to protect, then add to the desired images, and then select .

Set All In Event:

You can protect all images in the selected date at one time. Select the date you want to protect using / , and then select .

Remove All In Event:

You can remove the protection from all images in the selected date at one time. Select the date you want to remove the protection using / , and then select .

Note

- You cannot select multiple dates.

Notes on use

4-531-544-11(1)

Copyright 2014 Sony Corporation



Digital HD Video Camera Recorder
HDR-CX240/CX240E/PJ240/PJ240E/PJ270/PJ270E/PJ275

Copy

You can copy images stored on the recording media of this product. The original copy of the image will not be deleted after the copy operation has been completed. After you select [Copy], a display asking you to select the source and the destination for the images to be copied appears. Select the desired item.

1. - [Edit/Copy] - [Copy] - desired source and desired destination for the images - desired setting.

Descriptions of menu items

Multiple Images:

You can select images to be copied. Select the type of image you want to copy, then add to the desired images, and then select .

All In Event:

You can copy all images in the selected date at one time.

Select the date you want to copy using / , and then select .

Note

- When you record an image on the memory card for the first time, create the image database file by selecting [Repair Img. DB F.] - [Memory Card]. (HDR-PJ270/PJ270E/PJ275)
- Connect this product to a wall outlet (wall socket) using the supplied AC Adaptor to prevent this product from running out of power during copy.

Related Topic

- [Repair Img. DB F.](#)
- [Media Select \(HDR-PJ270/PJ270E/PJ275\)](#)

Notes on use

4-531-544-11(1)

Copyright 2014 Sony Corporation



Digital HD Video Camera Recorder
HDR-CX240/CX240E/PJ240/PJ240E/PJ270/PJ270E/PJ275

Media Select (HDR-PJ270/PJ270E/PJ275)

You can select your desired medium for recording, playback and editing.

1. **MENU** - [Setup] - [Media Settings] - [Media Select] - desired recording medium.

Descriptions of menu items

Int. Memory (default setting):

Records, plays or edits images on the internal memory.

Memory Card:

Records, plays or edits images on a memory card.

Note

- You cannot select a different recording medium for movies and for photos.

Related Topic

- [Screen indicators](#)
- [Expected recording time of movies](#)
- [Expected number of recordable photos](#)

Notes on use

4-531-544-11(1)

Copyright 2014 Sony Corporation



Digital HD Video Camera Recorder
HDR-CX240/CX240E/PJ240/PJ240E/PJ270/PJ270E/PJ275

Media Info

You can check the remaining recordable time and the approximate free and used space of the recording media.

1. **MENU** - [Setup] - [ Media Settings] - [Media Info].

Note

- Since there is a management file area, the used space is not displayed as 0% even if you perform [Format].

Related Topic

- [Media Select \(HDR-PJ270/PJ270E/PJ275\)](#)
- [Format](#)

Notes on use

4-531-544-11(1)

Copyright 2014 Sony Corporation



Digital HD Video Camera Recorder
HDR-CX240/CX240E/PJ240/PJ240E/PJ270/PJ270E/PJ275

Format

Formatting deletes all the movies and photos to recover recordable free space.

1. **MENU** - [Setup] - [Media Settings] - [Format] - desired recording medium, and select **OK**.

Note

- Connect this product to a wall outlet (wall socket) using the supplied AC Adaptor for this operation.
- To avoid the loss of important images, you should save them before formatting the recording media.
- Protected movies and photos will also be deleted.
- Make sure not to do the following while [Executing...] is displayed.
 - Open/Close the LCD monitor.
 - Operate buttons on this product.
 - Eject the memory card from this product.
 - Disconnect the AC Adaptor.
 - Remove the battery pack.

Hint

- Perform [Empty] to prevent data on the internal memory from being recovered. (HDR-PJ270/PJ270E/PJ275)

Related Topic

- [Protect](#)
- [Empty \(HDR-PJ270/PJ270E/PJ275\)](#)

Notes on use

4-531-544-11(1)

Copyright 2014 Sony Corporation



Digital HD Video Camera Recorder
HDR-CX240/CX240E/PJ240/PJ240E/PJ270/PJ270E/PJ275

Empty (HDR-PJ270/PJ270E/PJ275)

It is recommended that you perform [Empty] before disposing of or transferring this product to another party to prevent leakage of your personal information.

1. Connect the AC Adaptor to this product.
2. **MENU** - [Setup] - [Media Settings] - [Format] - [Int. Memory] - [Empty].

Note

- You cannot perform [Empty] unless you connect the AC Adaptor to the wall outlet (wall socket).
- To avoid the loss of important images, they should be saved on a computer or other devices before performing [Empty].
- Disconnect all cables except the AC Adaptor. Do not disconnect the AC Adaptor during the operation.
- If you stop performing [Empty] while [Executing...] appears, be sure to complete the operation by performing [Format] or [Empty] before you use this product next time.

Related Topic

 [Protect](#)

Notes on use

4-531-544-11(1)

Copyright 2014 Sony Corporation



Digital HD Video Camera Recorder
HDR-CX240/CX240E/PJ240/PJ240E/PJ270/PJ270E/PJ275

Repair Img. DB F.

Repair the image database file when necessary, such as when the image database repair message appears.

1. **MENU** - [Setup] - [ Media Settings] - [Repair Img. DB F.] - desired recording medium, and select **OK**

Notes on use

4-531-544-11(1)

Copyright 2014 Sony Corporation



Digital HD Video Camera Recorder
HDR-CX240/CX240E/PJ240/PJ240E/PJ270/PJ270E/PJ275

File Number

You can select the way to assign file number of photos/MP4 movies.

1. **MENU** - [Setup] - [Media Settings] - [File Number] - desired setting.

Descriptions of menu items

Series (default setting):

Assigns file numbers of photos/MP4 movies in sequence. The file number becomes larger each time you record a photo/MP4 movie.

Even if the memory card is replaced with another one, the file number is assigned in sequence.

Reset:

Assigns file numbers in sequence, following the largest file number existing on the recording medium. When the memory card is replaced with another one, the file number is assigned for each memory card.

Notes on use

4-531-544-11(1)

Copyright 2014 Sony Corporation



Digital HD Video Camera Recorder
 HDR-CX240/CX240E/PJ240/PJ240E/PJ270/PJ270E/PJ275

Data Code

During playback, this product displays the information recorded automatically at the time of recording. You can check the following information.

1. [MENU] - [Setup] - [▶ Playback Settings] - [Data Code] - desired setting.

Descriptions of menu items

Off (default setting):

Data code is not displayed.

Date/Time:

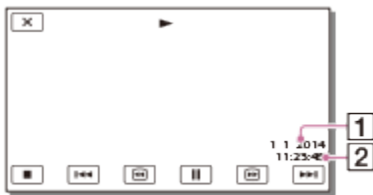

- 1 Date
- 2 Time

Camera Data:

Movie

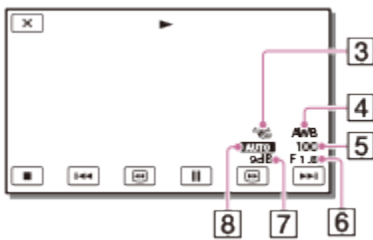

Photo



- 3 SteadyShot off
- 4 White Balance
- 5 Shutter Speed

- 6 F-stop
- 7 Gain
- 8 Brightness
- 9 Exposure

Note

- The data code is displayed on the TV screen if you connect this product to a TV.
- Depending on the recording media condition, [-- --] may appear.

Notes on use

4-531-544-11(1)

Copyright 2014 Sony Corporation



Digital HD Video Camera Recorder
HDR-CX240/CX240E/PJ240/PJ240E/PJ270/PJ270E/PJ275

Volume

You can adjust the volume of playback sound.

1. **MENU** - [Setup] - [**▶**] Playback Settings] - [Volume] - adjust the volume using **◀-** / **+▶** .

Notes on use

4-531-544-11(1)

Copyright 2014 Sony Corporation



Digital HD Video Camera Recorder
HDR-CX240/CX240E/PJ240/PJ240E/PJ270/PJ270E/PJ275

Motion Interval ADJ

Adjusts the residual image intervals of a motion shot video.

1. **MENU** - [Setup] - [**▶**] Playback Settings] - [Motion Interval ADJ].
2. Adjust the setting value of the residual image intervals with **-** / **+** .
3. Select **OK** .

Related Topic

- [Viewing trajectory of a moving object \(Motion Shot Video\)](#)

Notes on use

4-531-544-11(1)

Copyright 2014 Sony Corporation



Digital HD Video Camera Recorder
HDR-CX240/CX240E/PJ240/PJ240E/PJ270/PJ270E/PJ275

Download Music (HDR-CX240/PJ240/PJ270/PJ275)

You can transfer music files from audio CDs etc., to this product by connecting this product to a computer.

1. **MENU** - [Setup] - [**▶**] Playback Settings] - [Download Music].

Notes on use

4-531-544-11(1)

Copyright 2014 Sony Corporation



Digital HD Video Camera Recorder
HDR-CX240/CX240E/PJ240/PJ240E/PJ270/PJ270E/PJ275

Empty Music (HDR-CX240/PJ240/PJ270/PJ275)

You can delete all music files stored on this product.

1.  - [Setup] - [ Playback Settings] - [Empty Music].

Notes on use

4-531-544-11(1)

Copyright 2014 Sony Corporation



Digital HD Video Camera Recorder
HDR-CX240/CX240E/PJ240/PJ240E/PJ270/PJ270E/PJ275

WPS Push (HDR-PJ275)

If your access point has a WPS button, you can register the access point to this product easily.

1. **MENU** - [Setup] - [Connection] - [WPS Push].
2. Press the WPS button on the access point you want to register.

Note

- [WPS Push] requires that the security of the access point be WPA or WPA2 and that the WPS push button method is supported. If the security of your access point is set to WEP or your access point does not support the WPS push button method, register the access point manually.
- For details on the supported functions and settings for your access point, refer to the manual of your access point or contact the administrator of your access point.
- Depending on the surrounding conditions such as obstacles between this product and access point, signal condition and the materials of the wall, etc., connections may not be established or the communication distance may be shorter. Move this product or decrease the distance between this product and the access point.

Notes on use

4-531-544-11(1)

Copyright 2014 Sony Corporation



Digital HD Video Camera Recorder
HDR-CX240/CX240E/PJ240/PJ240E/PJ270/PJ270E/PJ275

Access point settings (HDR-PJ275)

You can register your access point manually. Before starting the procedure, check the SSID name, security mode, and password of the access point. The password may be preset in some devices. For details, see the access point operating instructions or contact the administrator.

1. [MENU] - [Setup] - [↔ Connection] - [Access point settings].
2. Select the access point you want to register.

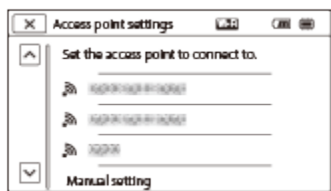

The desired access point is displayed:

Select the access point.

The desired access point is not displayed:

Select [Manual setting], then enter the SSID name of the access point, and then select the security mode.

3. Enter the password, and then select [Next] - [Register].

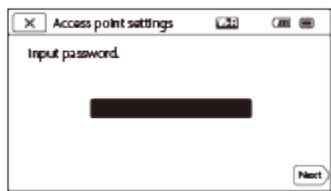

- Access points without the  icon do not require a password to be entered.

Other setting items

Depending on the status or the setting method of your access point, there may be more setting items.

WPS PIN:

Displays the PIN to enter to the connected device.

IP address setting:

Select [Auto] or [Manual].

IP address:

If you are entering the IP address manually, enter the fixed address.

Subnet mask/Default gateway:

When you set [IP address setting] to [Manual], enter the IP address and subnet mask to match your network environment.

Priority Connection:

Select [On] or [Off].

Note

- To give the registered access point priority, set [Priority Connection] to [On].

Hint

- For input method, see “How to use the keyboard.”

Related Topic

- [WPS Push \(HDR-PJ275\)](#)
- [How to use the keyboard \(HDR-PJ275\)](#)

[Notes on use](#)

4-531-544-11(1)

Copyright 2014 Sony Corporation



Digital HD Video Camera Recorder
HDR-CX240/CX240E/PJ240/PJ240E/PJ270/PJ270E/PJ275

Edit Device Name (HDR-PJ275)

You can change the device name for Wi-Fi Direct etc.

1. **MENU** - [Setup] - [Connection] - [Edit Device Name].
2. Select the input box, input the device name, and then select **OK**.

Hint

- For input method, see “How to use the keyboard.”

Related Topic

- [Access point settings \(HDR-PJ275\)](#)
- [How to use the keyboard \(HDR-PJ275\)](#)

Notes on use

4-531-544-11(1)

Copyright 2014 Sony Corporation



Digital HD Video Camera Recorder
HDR-CX240/CX240E/PJ240/PJ240E/PJ270/PJ270E/PJ275

Disp MAC Address (HDR-PJ275)

Display the MAC address of this product.

1. **MENU** - [Setup] - [Connection] - [Disp MAC Address].
 - The MAC address is displayed.

Notes on use

4-531-544-11(1)

Copyright 2014 Sony Corporation



Digital HD Video Camera Recorder
HDR-CX240/CX240E/PJ240/PJ240E/PJ270/PJ270E/PJ275

SSID/PW Reset (HDR-PJ275)

This product shares the SSID/password for [Send to Smartphone] and [Ctrl with Smartphone] with a device that has permission to connect. If you want to change the device that is permitted to connect to this product, reset the SSID/password by the following procedure.

1. **MENU** - [Setup] - [Connection] - [SSID/PW Reset] - **OK** .

Note

- After resetting the SSID/password, you must set the smartphone again.

Related Topic

- [Using your smartphone or tablet as a wireless remote commander \(models with the Wi-Fi/NFC functions\)](#)
- [Using your smartphone or tablet as a wireless remote commander using the NFC function \(NFC one-touch remote\) \(models with the Wi-Fi/NFC functions\)](#)
- [Transferring movies \(MP4\) and photos to your smartphone or tablet \(models with the Wi-Fi/NFC functions\)](#)
- [Transferring movies \(MP4\) and photos to your smartphone or tablet using the NFC function \(NFC one-touch sharing\) \(models with the Wi-Fi/NFC functions\)](#)

Notes on use

4-531-544-11(1)

Copyright 2014 Sony Corporation



Digital HD Video Camera Recorder
HDR-CX240/CX240E/PJ240/PJ240E/PJ270/PJ270E/PJ275

Network Info Reset (HDR-PJ275)

In addition to the SSID/password, you can also reset the information of the access point, etc. If you want to change the access point to connect to, reset the connection information by the following procedure.

1. **MENU** - [Setup] - [Connection] - [Network Info Reset].

Note

- After resetting the connection information, you must set the smartphone or the access point again.

Notes on use

4-531-544-11(1)

Copyright 2014 Sony Corporation



Digital HD Video Camera Recorder
HDR-CX240/CX240E/PJ240/PJ240E/PJ270/PJ270E/PJ275

TV Type

You need to convert the signal depending on the horizontal to vertical ratio of the TV connected.

1. **MENU** - [Setup] - [↔ Connection] - [TV Type] - desired setting.

Descriptions of menu items

16:9 (default setting):

Select this to view your movies on a 16:9 (wide) TV.

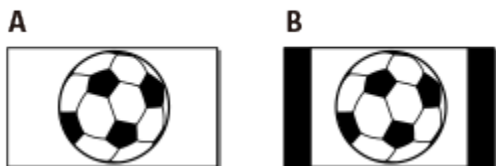

A: Images recorded in 16:9 (wide) mode

B: Images recorded in 4:3 mode

4:3:

Select this to view your movies and photos on a 4:3 standard TV.

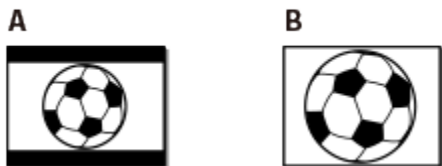

A: Images recorded in 16:9 (wide) mode

B: Images recorded in 4:3 mode

Notes on use

4-531-544-11(1)

Copyright 2014 Sony Corporation



Digital HD Video Camera Recorder
HDR-CX240/CX240E/PJ240/PJ240E/PJ270/PJ270E/PJ275

HDMI Resolution

Select the output image resolution when connecting this product to a TV with the HDMI cable.

1. **MENU** - [Setup] - [Connection] - [HDMI Resolution] - desired setting.

Descriptions of menu items

Auto (default setting):

Outputs the signal according to the TV automatically.

1080p:

Outputs the 1080p signal.

1080i:

Outputs the 1080i signal.

720p:

Outputs the 720p signal.

Notes on use

4-531-544-11(1)

Copyright 2014 Sony Corporation



Digital HD Video Camera Recorder
HDR-CX240/CX240E/PJ240/PJ240E/PJ270/PJ270E/PJ275

CTRL FOR HDMI

When connecting this product to a BRAVIA Sync compatible TV with an HDMI cable, you can play back movies on this product by aiming the TV's Remote Commander at the TV.

1. **MENU** - [Setup] - [Connection] - [CTRL FOR HDMI] - desired setting.

Descriptions of menu items

On (default setting):

Operates this product using the TV's Remote Commander.

Off:

Does not operate this product using the TV's Remote Commander.

Notes on use

4-531-544-11(1)

Copyright 2014 Sony Corporation



Digital HD Video Camera Recorder
HDR-CX240/CX240E/PJ240/PJ240E/PJ270/PJ270E/PJ275

USB Connect

Select this item if a USB connection does not start even when you connect this product to an external device with the Built-in USB Cable.

1. **MENU** - [Setup] - [Connection] - [USB Connect].

Notes on use

4-531-544-11(1)

Copyright 2014 Sony Corporation



Digital HD Video Camera Recorder
HDR-CX240/CX240E/PJ240/PJ240E/PJ270/PJ270E/PJ275

USB Connect Setting

You can set the USB transfer mode for connecting this product to a computer or other USB device.

1. **MENU** - [Setup] - [Connection] - [USB Connect Setting] - desired setting.

Descriptions of menu items

Auto (default setting):

This product automatically selects the USB transfer mode depending on the connected device.

MTP:

This is a USB transfer mode compatible with certain types of computers.

Mass Storage:

This is a USB transfer mode compatible with many types of USB devices.

Note

- When this product is connected to an external device in the [MTP] mode, image files will be displayed with the recorded date, however, some information included in the image files cannot be displayed on the connected device. To import images from this product to your computer, use the PlayMemories Home software.
- If the “Device Stage*” window does not open when you connect this product to a computer equipped with Windows 7 or Windows 8, set [USB Connect Setting] to [Auto].

*“Device Stage” is a menu of Windows 7 or Windows 8, that is used to manage devices (camcorder, camera, etc.) that are connected to the computer.

Notes on use

4-531-544-11(1)

Copyright 2014 Sony Corporation



Digital HD Video Camera Recorder
HDR-CX240/CX240E/PJ240/PJ240E/PJ270/PJ270E/PJ275

USB Power Supply

Set whether to use USB power supplied function when this product is connected to the AC Adaptor or a USB device such as a computer.

1. **MENU** - [Setup] - [Connection] - [USB Power Supply].

Descriptions of menu items

On (default setting):

Power is supplied when connected using the Built-in USB Cable.

Off:

Does not supply power when connected using the Built-in USB Cable.

Note

- If you changed this setting while the Built-in USB Cable was connected to this product, disconnect the Built-in USB Cable and connect it again.
- The setting of [USB Power Supply] is effective only when this product is connected to a USB device that is compatible with the 500 mA power supply standard.
- Only the playback functions are available while this product is connected to a USB device that is compatible with the 500 mA power supply standard.

Notes on use

4-531-544-11(1)

Copyright 2014 Sony Corporation



Digital HD Video Camera Recorder
HDR-CX240/CX240E/PJ240/PJ240E/PJ270/PJ270E/PJ275

USB LUN Setting

Improves compatibility with external devices by limiting the functions of the USB connection.

1. **MENU** - [Setup] - [Connection] - [USB LUN Setting] - desired setting.

Descriptions of menu items

Multi (default setting):

Use this setting for ordinary operations.

Single:

Try this setting only if you cannot connect to an external device.

Notes on use

4-531-544-11(1)

Copyright 2014 Sony Corporation



Digital HD Video Camera Recorder
HDR-CX240/CX240E/PJ240/PJ240E/PJ270/PJ270E/PJ275

Beep

You can turn on or off the melody which sounds when you start/stop recording, or operate this product.

1. **MENU** - [Setup] - [ General Settings] - [Beep] - desired setting.

Descriptions of menu items

On (default setting):

A melody sounds.

Off:

Cancels the melody.

Notes on use

4-531-544-11(1)

Copyright 2014 Sony Corporation



Digital HD Video Camera Recorder
HDR-CX240/CX240E/PJ240/PJ240E/PJ270/PJ270E/PJ275

Monitor Brightness

You can adjust the brightness of the LCD monitor.

1. **MENU** - [Setup] - [ General Settings] - [Monitor Brightness] - desired setting.

Descriptions of menu items

Normal (default setting):

Normal setting (normal brightness).

Bright:

Select this when the LCD monitor is not bright enough. This adjustment does not affect the recorded images in any way.

Notes on use

4-531-544-11(1)

Copyright 2014 Sony Corporation



Digital HD Video Camera Recorder
HDR-CX240/CX240E/PJ240/PJ240E/PJ270/PJ270E/PJ275

Airplane Mode (HDR-PJ275)

When you board an airplane, you can deactivate the Wi-Fi function temporarily.

1. **MENU** - [Setup] - [General Settings] - [Airplane Mode] - desired setting.

Descriptions of menu items

Off (default setting):

Normal setting.

On ():

Use the setting when you are on board an airplane.

Notes on use

4-531-544-11(1)

Copyright 2014 Sony Corporation



Digital HD Video Camera Recorder
HDR-CX240/CX240E/PJ240/PJ240E/PJ270/PJ270E/PJ275

Language Setting

You can select the language to be used on the LCD monitor.

1. **MENU** - [Setup] - [ General Settings] - [Language Setting] - desired language.

Notes on use

4-531-544-11(1)

Copyright 2014 Sony Corporation



Digital HD Video Camera Recorder
HDR-CX240/CX240E/PJ240/PJ240E/PJ270/PJ270E/PJ275

Power Save

You can change the settings for the backlight of the LCD monitor and the power status of this product.

1. **MENU** - [Setup] - [General Settings] - [Power Save].

Descriptions of menu items

Standard (default setting):

The backlight of the LCD monitor turns dark automatically if you do not attempt to operate this product for more than about 1 minute. This product turns off automatically if you do not attempt to operate this product for more than about 2 minutes.

Max:

The brightness of the LCD monitor is adjusted to the surrounding brightness automatically. The backlight of the LCD monitor turns dark automatically if you do not attempt to operate this product for more than about 15 seconds. This product turns off automatically if you do not attempt to operate this product for more than about 1 minute.

Off:

The backlight of the LCD monitor is always on brightly. This product does not turn off automatically.

Notes on use

4-531-544-11(1)

Copyright 2014 Sony Corporation



Digital HD Video Camera Recorder
HDR-CX240/CX240E/PJ240/PJ240E/PJ270/PJ270E/PJ275

Initialize

All the settings return to the default.

1. **MENU** - [Setup] - [General Settings] - [Initialize] - **OK**.

Hint

- Even if you use this function, all movies and photos are retained.

Notes on use

4-531-544-11(1)

Copyright 2014 Sony Corporation



Digital HD Video Camera Recorder
HDR-CX240/CX240E/PJ240/PJ240E/PJ270/PJ270E/PJ275

Demo Mode

When this product is connected to a wall outlet (wall socket) using the supplied AC Adaptor and no operation is attempted within a certain period with the movie recording mode or the Event View mode set, a demonstration movie starts playing.

1. **MENU** - [Setup] - [General Settings] - [Demo Mode] - desired setting.

Descriptions of menu items

On (default setting):

Make the settings for playback of the demonstration movie.

Off:

The demonstration does not appear.

Note

- In the default setting, the protected demonstration movie is pre-recorded in the Event View. If you delete the demonstration movie, you cannot recover it (HDR-PJ270/PJ270E/PJ275).
- A movie you have recorded will be registered as the demonstration movie if it satisfies all of the following conditions (HDR-PJ270/PJ270E/PJ275).
 - _ The movie is protected.
 - _ The movie is the one that was recorded first.
 - _ The movie is saved on the internal memory.
 - _ The movie is recorded in the AVCHD format.
- When you operate this product, the demonstration playback will be suspended.

Notes on use

4-531-544-11(1)

Copyright 2014 Sony Corporation



Digital HD Video Camera Recorder
HDR-CX240/CX240E/PJ240/PJ240E/PJ270/PJ270E/PJ275

Date & Time Setting

Set the date & time settings.

1. **[MENU]** - [Setup] - [Clock Settings] - [Date & Time Setting] - desired setting.

Descriptions of menu items

Date & Time Format:

You can select the order of year, month and day displayed.

Daylight Savings/Summer Time:

Sets the summertime. The clock is set to move the time forward 1 hour.

Date & Time:

You can set the clock.

Notes on use

4-531-544-11(1)

Copyright 2014 Sony Corporation



Digital HD Video Camera Recorder
HDR-CX240/CX240E/PJ240/PJ240E/PJ270/PJ270E/PJ275

Area Setting

You can adjust a time difference without stopping the clock. Select your local area when using this product in other time zones.

1. **MENU** - [Setup] - [Clock Settings] - [Area Setting] - [Home] - desired setting.

Hint

- You can set another place as a [Destination].

Related Topic

● [World time difference](#)

Notes on use

4-531-544-11(1)

Copyright 2014 Sony Corporation



Digital HD Video Camera Recorder
HDR-CX240/CX240E/PJ240/PJ240E/PJ270/PJ270E/PJ275

Charging time

Approximate time (min.) required when you fully charge a fully discharged battery pack.

When using the AC Adaptor

155 min

When using your computer

275 min

Hint

- The charging times shown in the table above are measured when charging this product at a temperature of 25 °C (77 °F). It is recommended that you charge the battery in a temperature range of 10 °C to 30 °C (50 °F to 86 °F).
- The charging times are measured without using the USB Connection support cable.

Notes on use

4-531-544-11(1)

Copyright 2014 Sony Corporation



Digital HD Video Camera Recorder
HDR-CX240/CX240E/PJ240/PJ240E/PJ270/PJ270E/PJ275

Expected recording time with NP-BX1

Approximate recording time with NP-BX1 is shown as follows.

HDR-CX240/CX240E

Continuous recording time

130 min

Typical recording time

65 min

HDR-PJ240/PJ240E/PJ270/PJ270E/PJ275

Continuous recording time

125 min

Typical recording time

60 min

Hint

- Each recording time is measured with the following settings.
 - [REC Mode] is set to [Standard **HQ**]
 - [Dual Video REC] is set to [On]
- Typical recording time shows the time when you repeat recording start/stop, switching the [Shooting Mode], and zooming.
- Times measured when using this product at 25 °C (77 °F). 10 °C to 30 °C (50 °F to 86 °F) is recommended.
- The recording and playback time will be shorter, depending on the conditions under which you use this product, such as when use this product in low temperatures.

[Notes on use](#)

4-531-544-11(1)

Copyright 2014 Sony Corporation



Digital HD Video Camera Recorder
HDR-CX240/CX240E/PJ240/PJ240E/PJ270/PJ270E/PJ275

Expected playback time with NP-BX1

Approximate playback time with NP-BX1 is shown as follows.

210 min

Notes on use

4-531-544-11(1)

Copyright 2014 Sony Corporation



Digital HD Video Camera Recorder
HDR-CX240/CX240E/PJ240/PJ240E/PJ270/PJ270E/PJ275

Notes on recording movies

Read the following precautions regarding movie recording.

Note

- The recordable time may vary depending on the recording and subject conditions and [ REC Mode].
- You can record movies of a maximum of 3,999 scenes with high definition image quality (HD). And you can record a maximum of 40,000 MP4 movies and photos collectively.
- The maximum continuous recording time of a movie is approximately 13 hours.
- This product uses the VBR (Variable Bit Rate) format to automatically adjust image quality to suit the recording scene. This technology causes fluctuations in the recording time of the media. Movies containing quickly moving and complex images are recorded at a higher bit-rate, and this reduces the overall recording time.

Notes on use

4-531-544-11(1)

Copyright 2014 Sony Corporation



Digital HD Video Camera Recorder
HDR-CX240/CX240E/PJ240/PJ240E/PJ270/PJ270E/PJ275

Expected recording time of movies

The expected recording time when saving on the internal memory is shown as follows.

HDR-PJ270/PJ270E/PJ275:

60p Quality PS (*)/50p Quality PS (**):

[Dual Video REC] is set to [Off]: 35 min (35 min)

Highest Quality FX:

[Dual Video REC] is set to [On]: 35 min (35 min)

[Dual Video REC] is set to [Off]: 45 min (45 min)

High Quality FH:

[Dual Video REC] is set to [On]: 50 min (50 min)

[Dual Video REC] is set to [Off]: 1 h (1 h)

Standard HQ:

[Dual Video REC] is set to [On]: 1 h 20 min (1 h 5 min)

[Dual Video REC] is set to [Off]: 1 h 45 min (1 h 20 min)

Long Time LP:

[Dual Video REC] is set to [On]: 1 h 55 min (1 h 45 min)

[Dual Video REC] is set to [Off]: 3 h 10 min (2 h 35 min)

*Models with the NTSC color system

**Models with the PAL color system

Note

- The number in () is the minimum recordable time.
- If you want to record up to the maximum recording time, you need to delete the demonstration movie on this product (models with the internal memory).

Related Topic

- [Notes on recording movies](#)



Digital HD Video Camera Recorder
HDR-CX240/CX240E/PJ240/PJ240E/PJ270/PJ270E/PJ275

Expected number of recordable photos

The expected number of images you can save on the internal memory is shown as follows.
You can record a maximum of 33,500 MP4 movies and photos collectively.

Notes on use

4-531-544-11(1)

Copyright 2014 Sony Corporation



Digital HD Video Camera Recorder
HDR-CX240/CX240E/PJ240/PJ240E/PJ270/PJ270E/PJ275

Expected recording time of movies

The expected recording time of movies when saving on a memory card is shown as follows.

16 GB

60p Quality PS (*) / 50p Quality PS (**):

[Dual Video REC] is set to [Off]: 1 h 15 min (1 h 15 min)

Highest Quality FX:

[Dual Video REC] is set to [On]: 1 h 15 min (1 h 15 min)

[Dual Video REC] is set to [Off]: 1 h 30 min (1 h 30 min)

High Quality FH:

[Dual Video REC] is set to [On]: 1 h 40 min (1 h 40 min)

[Dual Video REC] is set to [Off]: 2 h (2 h)

Standard HQ:

[Dual Video REC] is set to [On]: 2 h 40 min (2 h 10 min)

[Dual Video REC] is set to [Off]: 3 h 35 min (2 h 45 min)

Long Time LP:

[Dual Video REC] is set to [On]: 3 h 55 min (3 h 25 min)

[Dual Video REC] is set to [Off]: 6 h 20 min (5 h 10 min)

32 GB

60p Quality PS (*) / 50p Quality PS (**):

[Dual Video REC] is set to [Off]: 2 h 30 min (2 h 30 min)

Highest Quality FX:

[Dual Video REC] is set to [On]: 2 h 35 min (2 h 35 min)

[Dual Video REC] is set to [Off]: 3 h (3 h)

High Quality FH:

[Dual Video REC] is set to [On]: 3 h 25 min (3 h 25 min)

[Dual Video REC] is set to [Off]: 4 h 5 min (4 h 5 min)

Standard HQ:

[Dual Video REC] is set to [On]: 5 h 25 min (4 h 20 min)

[Dual Video REC] is set to [Off]: 7 h 20 min (5 h 30 min)

Long Time LP:

[Dual Video REC] is set to [On]: 7 h 55 min (7 h)

[Dual Video REC] is set to [Off]: 12 h 50 min (10 h 30 min)

64 GB

60p Quality PS (*) / 50p Quality PS (**):

[Dual Video REC] is set to [Off]: 5 h 5 min (5 h 5 min)

Highest Quality FX:

[Dual Video REC] is set to [On]: 5 h 15 min (5 h 15 min)

[Dual Video REC] is set to [Off]: 6 h (6 h)

High Quality FH:

[Dual Video REC] is set to [On]: 6 h 55 min (6 h 55 min)

[Dual Video REC] is set to [Off]: 8 h 15 min (8 h 15 min)

Standard HQ:

[Dual Video REC] is set to [On]: 10 h 55 min (8 h 50 min)

[Dual Video REC] is set to [Off]: 14 h 40 min (11 h 5 min)

Long Time LP:

[Dual Video REC] is set to [On]: 15 h 55 min (14 h 5 min)

[Dual Video REC] is set to [Off]: 25 h 45 min (21 h)

*Models with the NTSC color system

**Models with the PAL color system

Note

- When using a Sony memory card.
- The number in () is the minimum recordable time.

Related Topic

● [Notes on recording movies](#)

Notes on use

4-531-544-11(1)

Copyright 2014 Sony Corporation



How to Use

Digital HD Video Camera Recorder
HDR-CX240/CX240E/PJ240/PJ240E/PJ270/PJ270E/PJ275

Expected number of recordable photos

The expected number of images you can save on a memory card is shown as follows.

When recording 9.2 M size of images

16 GB:

3,700 images

32 GB:

7,500 images

64 GB:

14,500 images

Note

- When using a Sony memory card.
- The number of recordable photos of memory card shown is for the maximum image size of this product. The actual number of recordable photos is displayed on the LCD monitor during recording.
- The number of recordable photos of memory card may vary depending on the recording conditions.
- The unique image processing system of Sony's BIONZ X allows still image resolution equivalent to the sizes described.

Notes on use

4-531-544-11(1)

Copyright 2014 Sony Corporation



Digital HD Video Camera Recorder
HDR-CX240/CX240E/PJ240/PJ240E/PJ270/PJ270E/PJ275

Bit-rate and recording pixels

The following list shows the bit-rate, pixels and aspect ratio of each recording mode for movies (movie + audio, etc.).

AVCHD:

PS: Max. 28 Mbps 1,920 x 1,080 pixels/60p(*) or 1,920 x 1,080 pixels/50p(**), AVC HD 28 M (PS), 16:9

FX: Max. 24 Mbps 1,920 x 1,080 pixels/60i(*) or 1,920 x 1,080 pixels/50i(**), AVC HD 24 M (FX), 16:9

FH: Approx. 17 Mbps (average) 1,920 x 1,080 pixels/60i(*) or 1,920 x 1,080 pixels/50i(**), AVC HD 17 M (FH), 16:9

HQ: Approx. 9 Mbps (average) 1,440 x 1,080 pixels/60i(*) or 1,440 x 1,080 pixels/50i(**), AVC HD 9 M (HQ), 16:9

LP: Approx. 5 Mbps (average) 1,440 x 1,080 pixels/60i(*) or 1,440 x 1,080 pixels/50i(**), AVC HD 5 M (LP), 16:9

MP4:

Approx. 3 Mbps (average) 1,280 x 720 pixels/30p(*) or 1,280 x 720 pixels/25p(**), 16:9

*Models with the NTSC color system

**Models with the PAL color system

Related Topic

● [Notes on recording movies](#)

Notes on use

4-531-544-11(1)

Copyright 2014 Sony Corporation



Digital HD Video Camera Recorder
HDR-CX240/CX240E/PJ240/PJ240E/PJ270/PJ270E/PJ275

Recording pixels and aspect ratio

The photo recording pixels and the aspect ratio.

Photo recording mode, Dual capture:

4,032 × 2,272 dots/16:9

3,024 × 2,272 dots/4:3

1,920 × 1,080 dots/16:9

640 × 480 dots/4:3

Capturing a photo from a movie:

1,920 × 1,080 dots/16:9

[Notes on use](#)

4-531-544-11(1)

Copyright 2014 Sony Corporation



Digital HD Video Camera Recorder
HDR-CX240/CX240E/PJ240/PJ240E/PJ270/PJ270E/PJ275

About the AVCHD format

What is the AVCHD format?

The AVCHD format is a high definition digital video camera format used to record a high definition (HD) signal using efficient data compression coding technology. The MPEG-4 AVC/H.264 format is adopted to compress video data, and the Dolby Digital or Linear PCM system is used to compress audio data.

The MPEG-4 AVC/H.264 format is capable of compressing images at higher efficiency than that of the conventional image compressing format.

Hint

- As the AVCHD format uses a compression coding technology, the picture may be disturbed in scenes where picture, field angles or brightness, etc. change drastically, but this is not a malfunction.

Notes on use

4-531-544-11(1)

Copyright 2014 Sony Corporation



Digital HD Video Camera Recorder
HDR-CX240/CX240E/PJ240/PJ240E/PJ270/PJ270E/PJ275

About the memory card

- A memory card formatted by a computer (Windows OS/Mac OS) is not guaranteed to be compatible with this product.
- Data read/write speed may vary depending on the combination of the memory card and memory card compliant product you use.
- Data may be damaged or lost in the following cases (the data will not be compensated for):
 - _ If you eject the memory card, or turn off this product while this product is reading or writing image files on the memory card (while the access lamp is lit or flashing)
 - _ If you use the memory card near magnets or magnetic fields
- It is recommended that you make a back-up of important data on the hard disk of a computer.
- Do not attach a label or the like on memory card or memory card adaptor.
- Do not touch, or allow metallic objects to come into contact with the terminals.
- Do not bend, drop or apply strong force to the memory card.
- Do not disassemble or modify the memory card.
- Do not allow the memory card to get wet.
- Keep the memory card out of the reach of small children. There is danger that a child might swallow it.
- Do not insert anything other than the compliant size of memory card into the memory card slot. Doing so may cause a malfunction.
- Do not use or keep the memory card in the following locations:
 - _ Places subject to extremely high temperature, such as a car parked outside in the sun
 - _ Places under direct sunlight
 - _ Places with extremely high humidity or subject to corrosive gases

On image data compatibility

- Image data files recorded on memory card by this product conform to the “Design rule for Camera File system” universal standard established by the JEITA (Japan Electronics and Information Technology Industries Association).
- If you cannot use memory cards that have been used with another device, format it with this product. Note that formatting erases all information on the memory card.
- You may not be able to play back images with this product:
 - _ When playing back image data modified on your computer
 - _ When playing back image data recorded with other devices

About the Memory Stick media

Memory Stick Micro media:

Recording/Playback: not supported

Memory Stick Micro (Mark2) media:

Recording/Playback: supported

- This product does not support 8-bit parallel data transfer but it supports 4-bit parallel data transfer the same as with Memory Stick PRO Duo media.
- This product cannot record or play back data that uses MagicGate technology. MagicGate is a copyright protection technology that records and transfers the contents in an encrypted format.

Related Topic

[Format](#)

Notes on use

4-531-544-11(1)

Copyright 2014 Sony Corporation



Digital HD Video Camera Recorder
HDR-CX240/CX240E/PJ240/PJ240E/PJ270/PJ270E/PJ275

About the battery pack

To charge the battery pack

- Be sure to charge the battery pack before you start using this product.
- We recommend that you charge the battery pack in an ambient temperature range of 10 °C to 30 °C (50 °F to 86 °F) until the POWER/CHG (charge) lamp turns off. If you charge the battery pack outside of this temperature range, you may not be able to charge it efficiently.
- The POWER/CHG (charge) lamp flashes during charging under the following conditions.
 - The battery pack is not inserted correctly.
 - The battery pack is damaged.
 - The temperature of the battery pack is low.
Remove the battery pack from this product and put it in a warm place.
 - The temperature of the battery pack is high.
Remove the battery pack from this product and put it in a cool place.

To use the battery pack effectively

- Battery pack performance decreases when the ambient temperature is 10 °C (50 °F) or below, and the length of time you can use the battery pack becomes shorter. If that happens, one of the following is recommended to enable longer use of the battery pack:
 - Put the battery pack in a pocket to warm it up, and install it on this product immediately before you start shooting.
- Frequent use of the LCD monitor or a frequent playback, fast forward or reverse operation wears out the battery pack faster.
- Be sure to close the LCD monitor when not recording or playing back on this product. The battery pack is also consumed when this product is in recording standby or playback pause.
- Have spare battery packs ready for 2 or 3 times the expected recording time, and make trial recordings before making the actual recording.
- Do not expose the battery pack to water. The battery pack is not water resistant.
- You may not be able to turn on this product or the battery pack may not be effectively charged if the terminal section of the battery is dirty. In this case, wipe any dust off lightly using a soft cloth or a cotton swab to clean the battery.

About the remaining battery power indicator

- When the power goes off even though the remaining battery power indicator indicates that the battery pack has enough power to operate, charge the battery pack fully again. Remaining battery power will be indicated correctly. Note, however, that the battery indication will not be restored if it is used in high temperatures for a long time, or if left in a fully charged state, or when the battery pack is frequently used.

About storage of the battery pack

- If the battery pack is not used for a long time, fully charge the battery pack and use it up on this product once a year to maintain proper function. To store the battery pack, remove it from this product and put it in a dry, cool place.
- To discharge the battery pack on this product completely, select **MENU** - [Setup] - [ General Settings] - [Power Save] - [Off], and leave this product in recording standby until the power goes off.
- To prevent staining the terminal, short-circuiting, etc., be sure to use a supplied battery case when carrying or storing.

About battery life

- Battery capacity decreases over time and through repeated use. If the interval between charges becomes significantly short, the battery pack may need to be replaced with a new one.
- Each battery's life depends on storage, operating and environmental conditions.

Related Topic

 [Power Save](#)

Notes on use

4-531-544-11(1)

Copyright 2014 Sony Corporation



Digital HD Video Camera Recorder
HDR-CX240/CX240E/PJ240/PJ240E/PJ270/PJ270E/PJ275

On use and care

On recording

- Before starting to record, test the recording function to make sure the image and sound are recorded without any problems.
- Compensation for the contents of recordings cannot be provided, even if recording or playback is not possible due to a malfunction of this product, recording media, etc.
- TV color systems differ depending on the country/region. To view your recordings on a TV, you need a TV that supports the signal format for this product.
- Television programs, films, video tapes, and other materials may be copyrighted. Unauthorized recording of such materials may be contrary to the copyright laws.

LCD monitor

- The LCD monitor is manufactured using extremely high-precision technology, so over 99.99% of the pixels are operational for effective use. However, there may be some tiny black points and/or bright points (white, red, blue, or green in color) that appear constantly on the LCD monitor. These points are normal results of the manufacturing process and do not affect the shooting in any way.

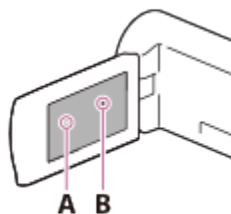

A: White, red, blue or green points

B: Black points

About this Help Guide, illustrations and on-screen displays

- The example images used in this Help Guide for illustration purposes are captured using a digital still camera, and therefore may appear different from images and screen indicators that actually appear on this product. And, the illustrations of this product and its screen indication are exaggerated or simplified for understandability.
- Design and specifications of this product and accessories are subject to change without notice.
- In this Help Guide, DVD discs recorded with high definition image quality (HD) are called AVCHD disc.
- In this Help Guide, the internal memory (models with the internal memory) and memory card are called “recording media.”

On use and storage place

- This product is not dustproofed, dripproofed or waterproofed.
- Do not hold this product by the following parts, and also do not hold this product by the jack covers.²⁶³

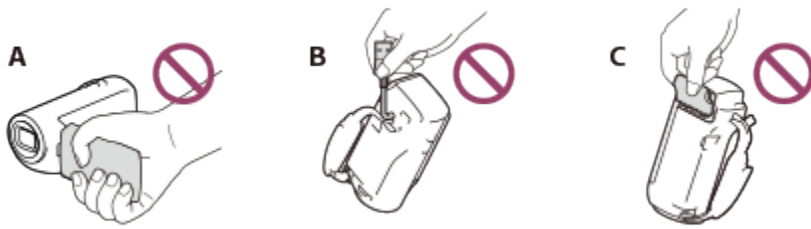

- A: LCD monitor
- B: Built-in USB Cable
- C: Battery cover

- Do not aim this product at the sun. Doing so might cause this product to malfunction. Take images of the sun only in low light conditions, such as at dusk.
- Do not use or store this product and accessories in the following locations:
 - Anywhere extremely hot, cold or humid. Never leave them exposed to temperatures above 60 °C (140 °F), such as under direct sunlight, near heaters or in a car parked in the sun. They may malfunction or become deformed.
 - Near strong magnetic fields or mechanical vibration. This product may malfunction.
 - Near strong radio waves or radiation. This product may not be able to record properly.
 - Near tuner devices such as TVs or radio. Noise may occur.
 - On a sandy beach or anywhere dusty. If sand or dust gets in this product, it may malfunction. Sometimes this malfunction cannot be repaired.
 - Near windows or outdoors, where the LCD monitor, or the lens may be exposed to direct sunlight. This damages the LCD monitor.
- For DC or AC operation, use the accessories recommended in these operating instructions.
- Do not let your product get wet, for example, from rain or sea water. If your product gets wet, it may malfunction. Sometimes this malfunction cannot be repaired.
- If any solid object or liquid gets inside the casing, unplug your product and have it checked by a Sony dealer before operating it any further.
- Avoid rough handling, disassembling, modifying, physical shock, or impact such as hammering, dropping or stepping on the product. Be particularly careful with the lens.
- Keep the LCD monitor closed when you are not using your product.
- Do not operate your product with it wrapped in an object such as a towel.
- When disconnecting the cable, pull it by the plug and not the cord.
- Do not damage the cable such as by placing anything heavy on it.
- Do not use a deformed or damaged battery pack.
- Keep metal contacts clean.
- If the battery electrolytic liquid has leaked:
 - Consult your local authorized Sony service facility.
 - Wash off any liquid that may have contacted your skin.
 - If any liquid gets in your eyes, wash with plenty of water and consult a doctor.

When not using this product for a long time

- To keep this product in optimum state for a long time, turn it on and let it run by recording and playing back images about once a month.
- Use up the battery pack completely before storing it.

Note on this product/battery pack temperature

- When the temperature of this product or battery pack becomes extremely high or extremely low, you may not be able to record or play back on this product, due to the protection features of this product being activated in such situations. In this case, an indicator appears on the LCD monitor.

Notes on charging through the Built-in USB Cable

- Charging may not be possible with all computers.
- If you connect this product to a laptop computer that is not connected to a power source, the battery of the laptop computer will continue to use up its charge. Do not leave this product connected to a computer in this manner.
- Charging with a personally assembled computer, with a converted computer, or through a USB hub are not guaranteed. This product may not function correctly depending on the USB device which is used with the computer.

LCD monitor

- Do not apply excessive pressure on the LCD monitor, as it may cause uneven color and other damage.
- If this product is used in a cold place, a residual image may appear on the LCD monitor. This is not a malfunction.
- While using this product, the back of the LCD monitor may heat up. This is not a malfunction.

ZEISS lens

- This product is equipped with a ZEISS lens, which was developed jointly by ZEISS, in Germany, and Sony Corporation, and produces superior images. It adopts the MTF(*) measurement system for video cameras and offers a quality typical of a ZEISS lens.

*MTF= Modulation Transfer Function. The number value indicates the amount of light from a subject coming into the lens.

On the pre-installed rechargeable battery

- This product has a pre-installed rechargeable battery to retain the date, time, and other settings even when the LCD monitor is closed. The pre-installed rechargeable battery is always charged while this product is connected to a wall outlet (wall socket) via the AC Adaptor or while the battery pack is inserted. The rechargeable battery will be fully discharged in about 2 months if you do not use this product at all. Charge the pre-installed rechargeable battery before you start using this product. However, even if the pre-installed rechargeable battery is not charged, this product operation other than date recording will not be affected.

How to charge the pre-installed rechargeable battery

Connect this product to a wall outlet (wall socket) using the supplied AC Adaptor, and leave it with the LCD monitor closed for more than 24 hours.

[Notes on use](#)

4-531-544-11(1)

Copyright 2014 Sony Corporation



Digital HD Video Camera Recorder
HDR-CX240/CX240E/PJ240/PJ240E/PJ270/PJ270E/PJ275

On connecting to a computer or accessory etc.

- Do not try to format the recording media of this product with a computer. If you do so, this product may not operate correctly.
- When connecting this product to another device with communication cables, be sure to insert the connector plug in the correct way. Pushing the plug forcibly into the terminal will damage the terminal and may result in a malfunction of this product.
- When this product is connected to other devices through a USB connection and the power of this product is turned on, do not close the LCD monitor. The image data that has been recorded may be lost.

Notes on use

4-531-544-11(1)

Copyright 2014 Sony Corporation



Digital HD Video Camera Recorder
HDR-CX240/CX240E/PJ240/PJ240E/PJ270/PJ270E/PJ275

Notes on optional accessories

- We recommend using genuine Sony accessories.
- Genuine Sony accessories may not be available in some countries/regions.

[Notes on use](#)

4-531-544-11(1)

Copyright 2014 Sony Corporation



Digital HD Video Camera Recorder
HDR-CX240/CX240E/PJ240/PJ240E/PJ270/PJ270E/PJ275

On moisture condensation

If this product is brought directly from a cold place to a warm place, moisture may condense inside this product. This may cause a malfunction to this product.

If moisture condensation occurs

Leave this product for about 1 hour without turning it on.

Where moisture condensation frequently occurs

Moisture may condense when you bring this product from a cold place into a warm place (or vice versa) or when you use this product in a humid place as follows:

- You bring this product from a ski slope into a place warmed up by a heating device.
- You bring this product from an air conditioned car or room into a hot place outside.
- You use this product after a squall or a rain.
- You use this product in a hot and humid place.

How to prevent moisture condensation

When you bring this product from a cold place into a warm place, put this product in a plastic bag and seal it tightly. Remove the bag when the air temperature inside the plastic bag has reached the surrounding temperature (after about 1 hour).

[Notes on use](#)

4-531-544-11(1)

Copyright 2014 Sony Corporation



Digital HD Video Camera Recorder
HDR-CX240/CX240E/PJ240/PJ240E/PJ270/PJ270E/PJ275

Notes on disposal/transfer the ownership of this product (models equipped with the internal memory)

Even if you delete all movies and still images, or perform [Format], data on the internal memory may not be completely erased. It is recommended that you perform [Empty] to prevent the recovery of your data.

Related Topic

[Format](#)

Notes on use

4-531-544-11(1)

Copyright 2014 Sony Corporation



How to Use

Digital HD Video Camera Recorder
HDR-CX240/CX240E/PJ240/PJ240E/PJ270/PJ270E/PJ275

On handling the LCD monitor

- If you leave fingerprints, hand cream, etc. on the LCD monitor, the coating of the LCD monitor will come off easily. Wipe those off as soon as possible.
- If you wipe the LCD monitor strongly with a tissue, etc., the coating of the LCD monitor may be scratched.
- If the LCD monitor becomes dirty with fingerprints or dust, it is recommended that you gently remove those from the screen then clean it with a soft cloth, etc.

Notes on use

4-531-544-11(1)

Copyright 2014 Sony Corporation



Digital HD Video Camera Recorder
HDR-CX240/CX240E/PJ240/PJ240E/PJ270/PJ270E/PJ275

To clean the casing and the projector lens surface (models with the projector)

- Wipe the casing and the lens gently with a soft cloth such as a cleaning cloth or eyeglass cleaning cloth.
- If the casing and the projector lens are very dirty, clean the casing of this product and the lens with a soft cloth lightly moistened with water, and then wipe the casing and the projector lens with a dry soft cloth.
- Avoid the following so as not to deform the casing, damage the finish or scratch the lens:
 - Using chemicals such as thinner, benzine, alcohol, chemical cloths, insect repellent, insecticide and sunscreen
 - Handling this product with the above substances on your hands
 - Leaving this product in contact with rubber or vinyl objects for a long period of time

Notes on use

4-531-544-11(1)

Copyright 2014 Sony Corporation



Digital HD Video Camera Recorder
HDR-CX240/CX240E/PJ240/PJ240E/PJ270/PJ270E/PJ275

About care and storage of the lens

- Wipe the surface of the lens clean with a soft cloth in the following instances:
 - _ When there are fingerprints on the lens surface
 - _ In hot or humid locations
 - _ When the lens is exposed to salty air such as at the seaside
- Store in a well-ventilated location subject to little dirt or dust.
- To prevent mold, periodically clean and store the lens as described above.

Notes on use

4-531-544-11(1)

Copyright 2014 Sony Corporation



Digital HD Video Camera Recorder
HDR-CX240/CX240E/PJ240/PJ240E/PJ270/PJ270E/PJ275

Using this product abroad

Power supply

- You can use this product in any countries/regions using the AC Adaptor supplied with this product within the AC 100 V to 240 V, 50 Hz/60 Hz range. You can also charge the battery pack.

Viewing images on a TV connected

- To view images on a TV (or monitor), you need to connect this product to a TV (or monitor) using the HDMI cable (supplied) or AV cable (sold separately). Refer to “On TV color systems” for countries and regions where the playback signal format of this product is supported.

Viewing high definition image quality (HD) movies

- In countries/regions where high definition image quality (HD) broadcasts are supported, you can view recorded movies on a TV at the same high definition image quality (HD) as they were recorded with this product.
To view images at the same high definition image quality (HD) as they were recorded with this product, you need the HDMI cable and a high definition TV (or monitor) that supports the signal format for this product and is equipped with an HDMI jack.

On TV color systems

- For signal formats supported by this product, refer to “Model Information.” To view images in this product on TV, use a TV (or monitor) that supports the signal format of this product.

PAL:

Australia, Austria, Belgium, China, Czech Republic, Denmark, Finland, Germany, Holland, Hong Kong, Hungary, Italy, Kuwait, Malaysia, New Zealand, Norway, Poland, Portugal, Singapore, Slovak Republic, Spain, Sweden, Switzerland, Thailand, United Kingdom, etc.

PAL-M:

Brazil

PAL-N:

Argentina, Paraguay, Uruguay



NTSC:

Bahama Islands, Bolivia, Canada, Central America, Chile, Colombia, Ecuador, Guyana, Jamaica, Japan, Korea, Mexico, Peru, Surinam, Taiwan, the Philippines, the USA, Venezuela, etc.

SECAM:

Bulgaria, France, Guiana, Iran, Iraq, Monaco, Russia, Ukraine, etc.

Setting to the local time

- You can easily set the clock to the local time by setting a time difference when using this product abroad. Select **MENU** - [Setup] - [ Clock Settings] - [Daylight Savings] or [Summer Time], and **MENU** - [Setup] - [ Clock Settings] - [Area Setting].

Related Topic

- [Connecting this product to a high definition TV](#)
- [Connecting this product to a non-high-definition TV](#)
- [World time difference](#)
- [Area Setting](#)
- [Date & Time Setting](#)

Notes on use

4-531-544-11(1)

Copyright 2014 Sony Corporation



Digital HD Video Camera Recorder
HDR-CX240/CX240E/PJ240/PJ240E/PJ270/PJ270E/PJ275

World time difference

The time difference for cities worldwide is shown as follows.

GMT:

Lisbon/London

+01:00:

Berlin/Paris

+02:00:

Helsinki/Cairo/Istanbul

+03:00:

Nairobi

+03:30:

Tehran

+04:00:

Moscow/Abu Dhabi/Baku

+04:30:

Kabul

+05:00:

Karachi/Islamabad

+05:30:

Kolkata/New Delhi

+06:00:

Almaty/Dhaka

+06:30:

Yangon

+07:00:

Bangkok/Jakarta

+08:00:

HongKong/Singapore/Beijing

+09:00:

Tokyo/Seoul

+09:30:

Adelaide/Darwin

+10:00:

Melbourne/Sydney

+11:00:

Solomon Is

+12:00:

Fiji/Wellington

-11:00:

Midway Island

-10:00:

Hawaii

-09:00:

Alaska

-08:00:

LosAngeles/Tijuana

-07:00:

Denver/Arizona

-06:00:

Chicago/MexicoCity

-05:00:

New York/Bogota

-04:00:

Santiago

-03:30:

St. John's

-03:00:

Brasilia/Montevideo

-02:00:

Fernando de Noronha

-01:00:

Azores/Cape Verde Is.

[Notes on use](#)



4-531-544-11(1)

Copyright 2014 Sony Corporation



Digital HD Video Camera Recorder
HDR-CX240/CX240E/PJ240/PJ240E/PJ270/PJ270E/PJ275

On trademarks

- Handycam and **HANDYCAM** are registered trademarks of Sony Corporation.
- AVCHD, AVCHD logotype, AVCHD Progressive and AVCHD Progressive logotype are trademarks of Panasonic Corporation and Sony Corporation.
- PlayMemories Home, the PlayMemories Home logo, PlayMemories Online, the PlayMemories Online logo, PlayMemories Mobile and the PlayMemories Mobile logo are trademarks of Sony Corporation.
- Memory Stick, , Memory Stick Duo, **MEMORY STICK DUO**, Memory Stick PRO Duo, **MEMORY STICK PRO DUO**, Memory Stick PRO-HG Duo, **MEMORY STICK PRO-HG DUO**, Memory Stick Micro, Memory Stick XC-HG Duo, **MEMORY STICK XC-HG DUO**, MagicGate, **MAGIC GATE**, MagicGate Memory Stick and MagicGate Memory Stick Duo are trademarks or registered trademarks of Sony Corporation.
- BIONZ X is a trademark of Sony Corporation.
- BRAVIA and Photo TV HD are trademarks of Sony Corporation.
- Blu-ray Disc™ and Blu-ray™ are trademarks of the Blu-ray Disc Association.
- Dolby and the double-D symbol are trademarks of Dolby Laboratories.
- The terms HDMI and HDMI High-Definition Multimedia Interface, and the HDMI Logo are trademarks or registered trademarks of HDMI Licensing LLC in the United States and other countries.
- Microsoft, Windows, Windows Vista, and DirectX are either registered trademarks or trademarks of Microsoft Corporation in the United States and/or other countries.
- Mac and Mac OS are registered trademarks of Apple Inc. in the United States and other countries.
- iPhone and iPad are trademarks of Apple Inc., registered in the U.S. and other countries.
- iOS is a registered trademark or trademark of Cisco Systems, Inc.
- Intel, Pentium and Intel Core are trademarks of Intel Corporation in the U.S. and/or other countries.
- Android and Google Play are trademarks of Google Inc.
- Wi-Fi, the Wi-Fi logo, Wi-Fi PROTECTED SET-UP, Wi-Fi Direct, WPA and WPA2 are registered trademarks of the Wi-Fi Alliance.
- DLNA and DLNA CERTIFIED are trademarks of Digital Living Network Alliance.
- The N mark is a trademark or registered trademark of NFC Forum, Inc. in the United States and in other countries.
- “” and “PlayStation” are registered trademarks of Sony Computer Entertainment Inc.
- microSDXC logo is a trademark of SD-3C, LLC.
- Facebook and the “f” logo are trademarks or registered trademarks of Facebook, Inc.
- YouTube and the YouTube logo are trademarks or registered trademarks of Google Inc.
- All other product names mentioned herein may be the trademarks or registered trademarks of their respective companies. Furthermore, ™ and ® are not mentioned in each case in this Help Guide.



Add further enjoyment with your PlayStation 3 by downloading the application for PlayStation 3 from PlayStation Store (where available.)

The application for PlayStation 3 requires PlayStation Network account and application download. Accessible in areas where the PlayStation Store is available.

[Notes on use](#)

4-531-544-11(1)

Copyright 2014 Sony Corporation



Digital HD Video Camera Recorder
HDR-CX240/CX240E/PJ240/PJ240E/PJ270/PJ270E/PJ275

Notes on the License

ANY USE OF THIS PRODUCT OTHER THAN CONSUMER PERSONAL USE IN ANY MANNER THAT COMPLIES WITH THE MPEG-2 STANDARD FOR ENCODING VIDEO INFORMATION FOR PACKAGED MEDIA IS EXPRESSLY PROHIBITED WITHOUT A LICENSE UNDER APPLICABLE PATENTS IN THE MPEG-2 PATENT PORTFOLIO, WHICH LICENSE IS AVAILABLE FROM MPEG LA, L.L.C., 250 STEELE STREET, SUITE 300, DENVER, COLORADO 80206.

THIS PRODUCT IS LICENSED UNDER THE AVC PATENT PORTFOLIO LICENSE FOR THE PERSONAL AND NON-COMMERCIAL USE OF A CONSUMER TO

- (i) ENCODE VIDEO IN COMPLIANCE WITH THE AVC STANDARD ("AVC VIDEO") AND/OR
- (ii) DECODE AVC VIDEO THAT WAS ENCODED BY A CONSUMER ENGAGED IN A PERSONAL AND NON-COMMERCIAL ACTIVITY AND/OR WAS OBTAINED FROM A VIDEO PROVIDER LICENSED TO PROVIDE AVC VIDEO.

NO LICENSE IS GRANTED OR SHALL BE IMPLIED FOR ANY OTHER USE.

ADDITIONAL INFORMATION MAY BE OBTAINED FROM MPEG LA, L.L.C.

SEE <[HTTP://WWW.MPEGLA.COM](http://www.mpegla.com)>

We provide the software in this product based on license agreements with the owners of the respective copyrights. Based on requests by the owners of copyright of these software applications, we have an obligation to inform you of the following. Please read the following sections.

Copies of the licenses (in English) are stored in the internal memory of this product. Establish a Mass Storage connection between this product and a computer, and read the files in the "LICENSE" folder in "PMHOME."

On GNU GPL/LGPL applied software

The software that is eligible for the following GNU General Public License (hereinafter referred to as "GPL") or GNU Lesser General Public License (hereinafter referred to as "LGPL") are included in this product.

This informs you that you have a right to have access to, modify, and redistribute source code for these software programs under the conditions of the supplied GPL/LGPL.

Source code is provided on the web. Use the following URL to download it. When downloading the source code, select HDR-PJ800 as the model for this product.

<http://www.sony.net/Products/Linux/>

We would prefer you do not contact us about the contents of source code.

Copies of the licenses (in English) are stored in the internal memory of this product. Establish a Mass Storage connection between this product and a computer, and read the files in the "LICENSE" folder in "PMHOME."

[Notes on use](#)



Digital HD Video Camera Recorder
HDR-CX240/CX240E/PJ240/PJ240E/PJ270/PJ270E/PJ275

Zoom magnifications

When recording a movie with SteadyShot set to [Active]

45 times

When recording a movie or photo with SteadyShot set to [Standard] or [Off]

54 times

When [Digital Zoom] is set to [320x]

320 times

Related Topic

 [Zooming](#)

Notes on use

4-531-544-11(1)

Copyright 2014 Sony Corporation



Troubleshooting

Digital HD Video Camera Recorder
HDR-CX240/CX240E/PJ240/PJ240E/PJ270/PJ270E/PJ275

If you have problems

If you run into any problems using this product, follow the steps below.

1. Check the items under “Troubleshooting,” and inspect this product.
2. Disconnect the power source, attach the power source again after about 1 minute, and turn this product on.
3. Perform [Initialize].
 - If you select [Initialize], all settings, including the clock setting, are reset.
4. Contact your Sony dealer or local authorized Sony service facility.

Note

- You may need to initialize or change the current internal memory (HDR-PJ270/PJ270E/PJ275) of this product depending on the problem.
If you do so, the data stored on the internal memory (HDR-PJ270/PJ270E/PJ275) will be deleted. Be sure to save the data on the internal memory (HDR-PJ270/PJ270E/PJ275) on other media (backup) before sending this product for repair. We will not compensate you for any loss of internal memory (HDR-PJ270/PJ270E/PJ275) data.
- During repair, we may check a minimum amount of data stored on the internal memory (HDR-PJ270/PJ270E/PJ275) in order to investigate the problem. However, your Sony dealer will neither copy nor retain your data.

Related Topic[Initialize](#)**Notes on use**

4-531-544-11(1)

Copyright 2014 Sony Corporation



Digital HD Video Camera Recorder
HDR-CX240/CX240E/PJ240/PJ240E/PJ270/PJ270E/PJ275

The power does not turn on.

- Insert a charged battery pack to this product.
- The plug of the AC Adaptor has been disconnected from a wall outlet (wall socket). Connect it to a wall outlet (wall socket).

Related Topic

- [Inserting the battery pack](#)
- [Charging the battery pack using the AC Adaptor](#)

Notes on use

4-531-544-11(1)

Copyright 2014 Sony Corporation



Digital HD Video Camera Recorder
HDR-CX240/CX240E/PJ240/PJ240E/PJ270/PJ270E/PJ275

This product does not operate even when the power is set to on.

- Disconnect the AC Adaptor from a wall outlet (wall socket) or remove the battery pack, then reconnect it after about 1 minute.

Related Topic

- [Inserting the battery pack](#)
- [Charging the battery pack using the AC Adaptor](#)

Notes on use



4-531-544-11(1)

Copyright 2014 Sony Corporation



Digital HD Video Camera Recorder
HDR-CX240/CX240E/PJ240/PJ240E/PJ270/PJ270E/PJ275

The menu settings have been changed automatically.

- While Intelligent Auto is active, some menu settings related to image quality will be changed automatically.
- The following menu items return to the default settings when you switch between movie recording, photo recording and playback modes.
 - [ Fader]
 - [ Self-Timer]

Related Topic

● [Fader](#)

● [Self-Timer](#)

Notes on use

4-531-544-11(1)

Copyright 2014 Sony Corporation



Troubleshooting

Digital HD Video Camera Recorder
HDR-CX240/CX240E/PJ240/PJ240E/PJ270/PJ270E/PJ275

This product gets warm.

- This product may become warm during operation. This is not a malfunction.

Notes on use

4-531-544-11(1)

Copyright 2014 Sony Corporation



Digital HD Video Camera Recorder
HDR-CX240/CX240E/PJ240/PJ240E/PJ270/PJ270E/PJ275

A rattling noise is heard when this product is shaken.

- If no noise is heard when this product is turned on and is in movie/photo recording mode, the noise is produced by the movement of the internal lens. This is not a malfunction.

[Notes on use](#)

4-531-544-11(1)

Copyright 2014 Sony Corporation



Digital HD Video Camera Recorder
HDR-CX240/CX240E/PJ240/PJ240E/PJ270/PJ270E/PJ275

Intelligent Auto is canceled.

- The Intelligent Auto setting is canceled if you change the following settings:
 - [White Balance]
 - [Exposure]
 - [Focus]
 - [Low Lux]
 - [Scene Selection]
 - [Auto Back Light]
 - [Face Detection]

Related Topic

- [White Balance](#)
- [Exposure](#)
- [Focus](#)
- [Low Lux](#)
- [Scene Selection](#)
- [Auto Back Light](#)
- [Face Detection](#)

Notes on use

4-531-544-11(1)

Copyright 2014 Sony Corporation



Digital HD Video Camera Recorder
HDR-CX240/CX240E/PJ240/PJ240E/PJ270/PJ270E/PJ275

The power abruptly turns off.

- Use the AC Adaptor.
- In the default setting, this product turns itself off when no operations are performed for more than about 2 minutes ([Power Save]). Change the setting of [Power Save], or turn on the power again.
- Charge the battery pack.

Related Topic

- [Power Save](#)
- [Charging the battery pack using the AC Adaptor](#)

Notes on use

4-531-544-11(1)

Copyright 2014 Sony Corporation



Digital HD Video Camera Recorder
HDR-CX240/CX240E/PJ240/PJ240E/PJ270/PJ270E/PJ275

The POWER/CHG (charge) lamp does not light while the battery pack is being charged.

- Turn off this product.
- Insert the battery pack to this product correctly.
- Connect the power cord (mains lead) to a wall outlet (wall socket) properly.
- The battery charge is completed.

Related Topic

- [Inserting the battery pack](#)
- [Charging the battery pack using the AC Adaptor](#)

Notes on use

4-531-544-11(1)

Copyright 2014 Sony Corporation



Digital HD Video Camera Recorder
HDR-CX240/CX240E/PJ240/PJ240E/PJ270/PJ270E/PJ275

The POWER/CHG (charge) lamp flashes while the battery pack is being charged.

- When the battery is being charged using the Built-in USB Cable, disconnect the Built-in USB Cable and connect it again.
- If the temperature of the battery pack is too high or too low, you may not be able to charge it.
- Insert the battery pack to this product correctly. If the problem persists, disconnect the AC Adaptor from a wall outlet (wall socket) and contact your Sony dealer. The battery pack may be damaged.

Notes on use

4-531-544-11(1)

Copyright 2014 Sony Corporation



Digital HD Video Camera Recorder
HDR-CX240/CX240E/PJ240/PJ240E/PJ270/PJ270E/PJ275

The remaining battery power is not displayed correctly.

- The ambient temperature is too high or too low. This is not a malfunction.
- The battery pack has not been charged enough. Fully charge the battery again. If the problem persists, replace the battery pack with a new one.
- The indicated remaining battery power may not be correct depending on the environment in which this product is used.

Notes on use

4-531-544-11(1)

Copyright 2014 Sony Corporation



Digital HD Video Camera Recorder
HDR-CX240/CX240E/PJ240/PJ240E/PJ270/PJ270E/PJ275

The battery pack is quickly discharged.

- The ambient temperature is too high or low. This is not a malfunction.
- The battery pack has not been charged enough. Fully charge the battery again. If the problem persists, replace the battery pack with a new one.

[Notes on use](#)

4-531-544-11(1)

Copyright 2014 Sony Corporation



Troubleshooting

Digital HD Video Camera Recorder
HDR-CX240/CX240E/PJ240/PJ240E/PJ270/PJ270E/PJ275

Menu items are grayed out.

- You cannot select grayed out items in the current recording/playback situation.
- There are some functions you cannot activate simultaneously.

[Notes on use](#)

4-531-544-11(1)

Copyright 2014 Sony Corporation



Digital HD Video Camera Recorder
HDR-CX240/CX240E/PJ240/PJ240E/PJ270/PJ270E/PJ275

The buttons do not appear on the LCD monitor.

- Use the multi-selector.

[Notes on use](#)

4-531-544-11(1)

Copyright 2014 Sony Corporation



Digital HD Video Camera Recorder
HDR-CX240/CX240E/PJ240/PJ240E/PJ270/PJ270E/PJ275

The buttons on the LCD monitor quickly disappear.

- If you set [Display Setting] to [On], the buttons do not disappear from the LCD monitor while in recording mode.

Related Topic

• [Display Setting](#)

Notes on use

4-531-544-11(1)

Copyright 2014 Sony Corporation



Digital HD Video Camera Recorder
HDR-CX240/CX240E/PJ240/PJ240E/PJ270/PJ270E/PJ275

There are dots in the shape of a grid on the monitor.

- These dots are a normal result of the manufacturing process of the monitor and do not affect the recording in any way.

[Notes on use](#)

4-531-544-11(1)

Copyright 2014 Sony Corporation



Digital HD Video Camera Recorder
HDR-CX240/CX240E/PJ240/PJ240E/PJ270/PJ270E/PJ275

The backlight of the LCD monitor turns off if you do not attempt to operate this product for a while.

- In the default setting, the backlight of the LCD monitor turns off automatically if you do not attempt to operate this product for more than about 1 minute ([Power Save]).

Related Topic

● [Power Save](#)

Notes on use

4-531-544-11(1)

Copyright 2014 Sony Corporation



Digital HD Video Camera Recorder
HDR-CX240/CX240E/PJ240/PJ240E/PJ270/PJ270E/PJ275

Operations using the memory card cannot be performed.

- If you use the memory card formatted on a computer, format it again on this product.

Related Topic

[Format](#)

Notes on use

4-531-544-11(1)

Copyright 2014 Sony Corporation



Digital HD Video Camera Recorder
HDR-CX240/CX240E/PJ240/PJ240E/PJ270/PJ270E/PJ275

Images stored on the memory card cannot be deleted.

- The maximum number of images that you can delete on the index screen at one time is 100.
- You cannot delete the protected images.

Related Topic

[Protect](#)

[Notes on use](#)

4-531-544-11(1)

Copyright 2014 Sony Corporation



Digital HD Video Camera Recorder
HDR-CX240/CX240E/PJ240/PJ240E/PJ270/PJ270E/PJ275

The data file name is not indicated correctly or flashes.

- The file is damaged.
- The file format is not supported by this product.

[Notes on use](#)

4-531-544-11(1)

Copyright 2014 Sony Corporation



Digital HD Video Camera Recorder
HDR-CX240/CX240E/PJ240/PJ240E/PJ270/PJ270E/PJ275

Images cannot be played back or the memory card is not recognized.

- The playback device does not support playing back memory cards.

[Notes on use](#)

4-531-544-11(1)

Copyright 2014 Sony Corporation



Digital HD Video Camera Recorder
HDR-CX240/CX240E/PJ240/PJ240E/PJ270/PJ270E/PJ275

Pressing START/STOP or PHOTO does not record images.

- The playback screen is displayed. Stop playback, and select **MENU** - [Shooting Mode] - [Movie] or [Photo].
- This product is recording the image you have just shot on the recording media. You cannot make new recording during this period.
- The recording media is full. Delete unnecessary images.
- Total number of movie scenes or photos exceeds the recordable capacity of this product. Delete unnecessary images.

Related Topic

[Delete](#)

Notes on use



4-531-544-11(1)

Copyright 2014 Sony Corporation



Digital HD Video Camera Recorder
HDR-CX240/CX240E/PJ240/PJ240E/PJ270/PJ270E/PJ275

Photos cannot be recorded.

- You cannot record photos together with:
 - [ Fader]
- This product cannot shoot photos while it is in movie recording mode, depending on the [ REC Mode] or [ Frame Rate] selected.
- When you select a [Picture Effect] item, you cannot record photos in the movie recording mode.

Related Topic

- [Fader](#)
- [REC Mode](#)
- [Frame Rate](#)
- [Picture Effect](#)

Notes on use

4-531-544-11(1)

Copyright 2014 Sony Corporation



Digital HD Video Camera Recorder
HDR-CX240/CX240E/PJ240/PJ240E/PJ270/PJ270E/PJ275

The access lamp remains lit or flashing even if recording has stopped.

- This product is recording the scene you have just shot on the memory card.

[Notes on use](#)

4-531-544-11(1)

Copyright 2014 Sony Corporation



Digital HD Video Camera Recorder
HDR-CX240/CX240E/PJ240/PJ240E/PJ270/PJ270E/PJ275

The imaging field looks different.

- The imaging field may look different depending on the condition of this product. This is not a malfunction.

[Notes on use](#)

4-531-544-11(1)

Copyright 2014 Sony Corporation



Digital HD Video Camera Recorder
HDR-CX240/CX240E/PJ240/PJ240E/PJ270/PJ270E/PJ275

The actual recording time for movies is less than the expected recording time of the recording media.

- Depending on the recording conditions, the time available for recording may be shorter, for example when recording a fast moving object, etc.

[Notes on use](#)

4-531-544-11(1)

Copyright 2014 Sony Corporation



Digital HD Video Camera Recorder
HDR-CX240/CX240E/PJ240/PJ240E/PJ270/PJ270E/PJ275

This product stops recording.

- If you keep applying vibration on this product, recording may stop.

[Notes on use](#)

4-531-544-11(1)

Copyright 2014 Sony Corporation



Digital HD Video Camera Recorder
HDR-CX240/CX240E/PJ240/PJ240E/PJ270/PJ270E/PJ275

There is a slight time lag between the moment when START/STOP is pressed and the actual movie recording starts or stops.

- On this product, there may be a slight time difference between the moment when you press START/STOP and when the actual movie recording starts/stops. This is not a malfunction.

Notes on use

4-531-544-11(1)

Copyright 2014 Sony Corporation



Digital HD Video Camera Recorder
HDR-CX240/CX240E/PJ240/PJ240E/PJ270/PJ270E/PJ275

The auto focus does not function.

- Set [Focus] to [Auto].
- If the auto focus does not lock on the subject, adjust the focus manually.

Related Topic

● [Focus](#)

[Notes on use](#)



4-531-544-11(1)

Copyright 2014 Sony Corporation



Digital HD Video Camera Recorder
HDR-CX240/CX240E/PJ240/PJ240E/PJ270/PJ270E/PJ275

SteadyShot does not function.

- Set [ SteadyShot] to [Active] or [Standard].
- Even if [ SteadyShot] is set to [Active] or [Standard], this product may not be able to compensate for excessive vibrations.

Related Topic

- [SteadyShot \(Movie\)](#)

Notes on use

4-531-544-11(1)

Copyright 2014 Sony Corporation



Digital HD Video Camera Recorder
HDR-CX240/CX240E/PJ240/PJ240E/PJ270/PJ270E/PJ275

Images cannot be recorded or played back correctly.

- If you record and delete images repeatedly for a long time, the files on the recording media may become fragmented and images cannot be recorded or played back correctly. After backing up the images on other media, perform [Format] of the recording media on this product.

Related Topic

 [Format](#)

Notes on use

4-531-544-11(1)

Copyright 2014 Sony Corporation



Digital HD Video Camera Recorder
HDR-CX240/CX240E/PJ240/PJ240E/PJ270/PJ270E/PJ275

The subjects passing across this product very fast appear crooked.

- This is called the focal plane phenomenon. This is not a malfunction. Because of the way the image device (CMOS sensor) reads out image signals, the subjects passing by the lens rapidly might appear crooked depending on the recording conditions.

Notes on use

4-531-544-11(1)

Copyright 2014 Sony Corporation



Digital HD Video Camera Recorder
HDR-CX240/CX240E/PJ240/PJ240E/PJ270/PJ270E/PJ275

Horizontal stripes appear on the images.

- This occurs when recording images under a fluorescent lamp, sodium lamp, or mercury lamp. This is not a malfunction.

[Notes on use](#)

4-531-544-11(1)

Copyright 2014 Sony Corporation



Digital HD Video Camera Recorder
HDR-CX240/CX240E/PJ240/PJ240E/PJ270/PJ270E/PJ275

[Monitor Brightness] cannot be set.

- You cannot set [Monitor Brightness] when:
 - _ The LCD monitor is closed on this product with the LCD monitor facing out.
 - _ The power is supplied from the AC Adaptor.

Related Topic

● [Monitor Brightness](#)

Notes on use

4-531-544-11(1)

Copyright 2014 Sony Corporation



Digital HD Video Camera Recorder
HDR-CX240/CX240E/PJ240/PJ240E/PJ270/PJ270E/PJ275

Photos are recorded automatically.

- When [Smile Shutter] is set to [Dual Capture] or [Always On], photos are recorded automatically when this product detects a smile.

Related Topic

● [Smile Shutter](#)

Notes on use

4-531-544-11(1)

Copyright 2014 Sony Corporation



Digital HD Video Camera Recorder
HDR-CX240/CX240E/PJ240/PJ240E/PJ270/PJ270E/PJ275

Images cannot be played back.

- Select the type of recording media you want to play back. (models with the internal memory)
- Select the movie type (HD/MP4) you want to play with the movie format select button.
- Images recorded on other devices may not be played back. This is not a malfunction.

Related Topic

- [Media Select \(HDR-PJ270/PJ270E/PJ275\)](#)
- [Playing MP4 movies \(HD movie\) \(switching the movie format\)](#)

Notes on use

4-531-544-11(1)

Copyright 2014 Sony Corporation



Digital HD Video Camera Recorder
HDR-CX240/CX240E/PJ240/PJ240E/PJ270/PJ270E/PJ275

Photos cannot be played back.

- You may not be able to play back photos if you have changed file or folder names, or have edited the data on a computer. (The file name flashes in that case.) This is not a malfunction.

[Notes on use](#)

4-531-544-11(1)

Copyright 2014 Sony Corporation



Digital HD Video Camera Recorder
HDR-CX240/CX240E/PJ240/PJ240E/PJ270/PJ270E/PJ275

The movie freezes.

- Photos which were recorded while recording a movie are played back. In the default setting, movies and photos are played back continuously.

[Notes on use](#)

4-531-544-11(1)

Copyright 2014 Sony Corporation



Digital HD Video Camera Recorder
HDR-CX240/CX240E/PJ240/PJ240E/PJ270/PJ270E/PJ275

An icon appears on a thumbnail.

- The image data base file may be damaged. Check the data base file by selecting **MENU** - [Setup] - [Media Settings] - [Repair Img. DB F.] - the recording medium. If it still appears, delete the image with
- may appear on an image recorded on other devices, edited on a computer, etc.
- You removed the AC Adaptor or the battery pack while the recording media icon at the top right corner of the screen is lit, or before the access lamp is turned off after recording. This may damage your image data and is displayed.

Related Topic

- [Repair Img. DB F.](#)
- [Delete](#)

Notes on use

4-531-544-11(1)

Copyright 2014 Sony Corporation



Troubleshooting

Digital HD Video Camera Recorder
HDR-CX240/CX240E/PJ240/PJ240E/PJ270/PJ270E/PJ275

No sound or only a quiet sound is heard during playback.

- Turn up the volume.

Related Topic

[Volume](#)

[Notes on use](#)

4-531-544-11(1)

Copyright 2014 Sony Corporation



Digital HD Video Camera Recorder
HDR-CX240/CX240E/PJ240/PJ240E/PJ270/PJ270E/PJ275

The wireless access point you want to connect to does not appear. (models with the Wi-Fi/NFC functions)

- Depending on the signal conditions, the wireless access point may not appear on this product. Move this product closer to the wireless access point.
- Depending on its setting, the wireless access point may not appear on this product. Refer to the instruction manual for the wireless access point for the correct settings.

Notes on use

4-531-544-11(1)

Copyright 2014 Sony Corporation



Digital HD Video Camera Recorder
HDR-CX240/CX240E/PJ240/PJ240E/PJ270/PJ270E/PJ275

[WPS Push] does not work. (models with the Wi-Fi/NFC functions)

- Depending on the wireless access point setting, [WPS Push] may not be available. Confirm the password and SSID of the wireless access point to set [Access point settings].

Related Topic

- [Access point settings \(HDR-PJ275\)](#)

Notes on use

4-531-544-11(1)

Copyright 2014 Sony Corporation



Digital HD Video Camera Recorder
HDR-CX240/CX240E/PJ240/PJ240E/PJ270/PJ270E/PJ275

[Ctrl with Smartphone], [Send to Smartphone], [Send to Computer] or [View on TV] terminates prematurely. (models with the Wi-Fi/NFC functions)

- If the battery level is low, [Ctrl with Smartphone], [Send to Smartphone], [Send to Computer] or [View on TV] may terminate prematurely. Charge the battery pack before use.

Notes on use

4-531-544-11(1)

Copyright 2014 Sony Corporation



Digital HD Video Camera Recorder
HDR-CX240/CX240E/PJ240/PJ240E/PJ270/PJ270E/PJ275

Cannot transfer movies to your smartphone. (models with the Wi-Fi/NFC functions)

- To send a movie to your smartphone, be sure to record it in the MP4 format. Before shooting a movie to be transferred to a smartphone, set [Dual Video REC] to [On].

Related Topic

• [Dual Video REC](#)

Notes on use

4-531-544-11(1)

Copyright 2014 Sony Corporation



Digital HD Video Camera Recorder
HDR-CX240/CX240E/PJ240/PJ240E/PJ270/PJ270E/PJ275

The shooting screen does not display smoothly. The connection is cut off. (models with the Wi-Fi/NFC functions)

- Depending on the signal conditions, communication between the smartphone and this product may not work correctly. Reduce the distance between this product and the smartphone.

Notes on use





4-531-544-11(1)

Copyright 2014 Sony Corporation



Digital HD Video Camera Recorder
HDR-CX240/CX240E/PJ240/PJ240E/PJ270/PJ270E/PJ275

The NFC connection does not work. (models with the Wi-Fi/NFC functions)

- Change the position of the compatible device to reduce the distance between  (N mark) on the smartphone and  (N mark) on this product.
If this still does not solve the problem, move the smartphone a few millimeters, or move the smartphone away from this product and wait for 10 seconds or more before touching again.
- This product is in [Airplane Mode]. Set [Airplane Mode] to [Off].
- Make sure that the smartphone is ready for communication. Refer to the instruction manual of your smartphone for details.
- Do not put any metal products other than the smartphone close to  (N mark) on this product.
- Do not touch  (N mark) on this product with 2 or more smartphones at the same time.
- When running another application that uses the NFC function on your smartphone, close the application.

Related Topic

- [Airplane Mode \(HDR-PJ275\)](#)

Notes on use

4-531-544-11(1)

Copyright 2014 Sony Corporation



Troubleshooting

Digital HD Video Camera Recorder
HDR-CX240/CX240E/PJ240/PJ240E/PJ270/PJ270E/PJ275

Unable to edit.

- Unable to edit because of the condition of the image.

[Notes on use](#)

4-531-544-11(1)

Copyright 2014 Sony Corporation



Digital HD Video Camera Recorder
HDR-CX240/CX240E/PJ240/PJ240E/PJ270/PJ270E/PJ275

A movie cannot be divided.

- The following movies cannot be divided.
 - _ Movies that are too short
 - _ MP4 movies
- Release the protection, and then divide.

Related Topic

[Protect](#)

Notes on use

4-531-544-11(1)

Copyright 2014 Sony Corporation



Digital HD Video Camera Recorder
HDR-CX240/CX240E/PJ240/PJ240E/PJ270/PJ270E/PJ275

The demonstration movies cannot be deleted. (models with the internal memory)

- Release the protection, and then delete them.

Related Topic

[Protect](#)

[Notes on use](#)

4-531-544-11(1)

Copyright 2014 Sony Corporation



Troubleshooting

Digital HD Video Camera Recorder
HDR-CX240/CX240E/PJ240/PJ240E/PJ270/PJ270E/PJ275

Neither image nor sound is played on the connected TV.

- Images are not output from the HDMI OUT jack, if copyright protection signals are recorded in the images.

Notes on use

4-531-544-11(1)

Copyright 2014 Sony Corporation



Digital HD Video Camera Recorder
HDR-CX240/CX240E/PJ240/PJ240E/PJ270/PJ270E/PJ275

The top, bottom, right, and left edges of images are trimmed slightly on a connected TV.

- The LCD monitor of this product can display recording images across the entire LCD monitor (full pixel display). However, this may cause slight trimming of the top, bottom, right, and left edges of images when played back on a TV which is not compatible with full pixel display.
- It is recommended you record images using the outer frame of [Grid Line] as a guide.

Related Topic

[Grid Line](#)

Notes on use

4-531-544-11(1)

Copyright 2014 Sony Corporation



Digital HD Video Camera Recorder
HDR-CX240/CX240E/PJ240/PJ240E/PJ270/PJ270E/PJ275

The image appears distorted on the 4:3 TV.

- This happens when viewing an image on a 4:3 TV. Set [TV Type] correctly and play back the image.

Related Topic

- [TV Type](#)

Notes on use

4-531-544-11(1)

Copyright 2014 Sony Corporation



Digital HD Video Camera Recorder
HDR-CX240/CX240E/PJ240/PJ240E/PJ270/PJ270E/PJ275

Black bands appear at the top and bottom of the LCD monitor of the 4:3 TV.

- This happens when viewing an image on a 4:3 TV. This is not a malfunction.

[Notes on use](#)

4-531-544-11(1)

Copyright 2014 Sony Corporation



Digital HD Video Camera Recorder
HDR-CX240/CX240E/PJ240/PJ240E/PJ270/PJ270E/PJ275

Images are not copied correctly.

- You cannot copy images using the HDMI cable.
- An AV cable (sold separately) is not connected properly. Make sure that the cable is connected to the input jack of the device.

[Notes on use](#)

4-531-544-11(1)

Copyright 2014 Sony Corporation



Digital HD Video Camera Recorder
HDR-CX240/CX240E/PJ240/PJ240E/PJ270/PJ270E/PJ275

PlayMemories Home cannot be installed.

- An Internet connection is required to install PlayMemories Home.
- Check the computer environment or installation procedure required to install PlayMemories Home.

Related Topic

- [Using the PlayMemories Home software](#)

Notes on use

4-531-544-11(1)

Copyright 2014 Sony Corporation



Digital HD Video Camera Recorder
HDR-CX240/CX240E/PJ240/PJ240E/PJ270/PJ270E/PJ275

PlayMemories Home does not work correctly.

- Quit PlayMemories Home and restart your computer.

Related Topic

• [Using the PlayMemories Home software](#)

[Notes on use](#)

4-531-544-11(1)

Copyright 2014 Sony Corporation



Digital HD Video Camera Recorder
HDR-CX240/CX240E/PJ240/PJ240E/PJ270/PJ270E/PJ275

This product is not recognized by the computer.

- Disconnect all USB devices from the USB jack of your computer except the keyboard, mouse, and this product.

[Notes on use](#)

4-531-544-11(1)

Copyright 2014 Sony Corporation



Digital HD Video Camera Recorder
HDR-CX240/CX240E/PJ240/PJ240E/PJ270/PJ270E/PJ275

Self-diagnosis display

If indicators appear on the LCD monitor, check the following. If the problem persists even after you have tried to fix a couple of times, contact your Sony dealer or local authorized Sony service facility. In this case, when you contact them, give them all the numbers of the error code beginning with C or E.



You may hear a melody when an important warning indicator appears on the LCD monitor.

C:(or E:) □ □ : □ □ (Self-diagnosis display)

C:04: □ □

You are not using the designated battery pack. Make sure to use the designated battery pack. Connect the AC Adaptor and the USB cable firmly.

C:06: □ □

The battery pack temperature is high. Change the battery pack or place it in a cool place.

C:13: □ □ / **C:32:** □ □

Remove the power source. Reconnect it and operate this product again.

E: □ □ : □ □

Follow the steps from 2 on "If you have problems."

 **(Battery level warning)**

The battery pack is nearly used up.

 **(Warning indicator pertaining to battery pack temperature)**

The battery pack temperature is high. Change the battery pack or place it in a cool place.

 **(Warning indicator pertaining to memory card)**

Slow flashing

Free spaces for recording images are running out.

No memory card is inserted.

Fast flashing

There is not enough free spaces for recording images. After storing the images on other media, delete unnecessary images, or format the memory card.

The image data base file may be damaged. Check the data base file by selecting **[MENU]** - **[Setup]** - **[Media Settings]** - **[Repair Img. DB F.]** - the recording medium.

The memory card is damaged.

 **(Warning indicators pertaining to memory card formatting)**

The memory card is damaged.

The memory card is not formatted correctly.

 **(Warning indicator pertaining to incompatible memory card)**

Incompatible memory card is inserted.

 **(Warning indicator pertaining to the write-protect of the memory card)**

The memory card is write-protected.

Access to the memory card was restricted on another device.

 **(Warning indicator pertaining to camera-shake warning)**



This product is unsteady, so camera-shake easily occurs. Hold this product steady with both hands and record the image. However, note that the camera shake warning indicator does not disappear.

 **(Warning indicator pertaining to photo recording)**

The recording media is full.

Photos cannot be recorded during processing. Wait for a while, then record.

You cannot capture photos while recording movies in the following situations:

- When [ REC Mode] is set to [Highest Quality **FX**]
- When the [ Frame Rate] is set to [60p] (models with NTSC color system) or [50p] (models with PAL color system)
- When an item of [Picture Effect] is selected

Related Topic

- [If you have problems](#)
- [Inserting a memory card](#)
- [Format](#)
- [About the battery pack](#)
- [Repair Img. DB F.](#)
- [REC Mode](#)
- [Frame Rate](#)
- [Picture Effect](#)
- [SteadyShot \(Movie\)](#)

[Notes on use](#)

4-531-544-11(1)

Copyright 2014 Sony Corporation



Digital HD Video Camera Recorder
HDR-CX240/CX240E/PJ240/PJ240E/PJ270/PJ270E/PJ275

Warning Indicators

If messages appear on the LCD monitor, follow the instructions.

Cannot recognize the internal memory. Format and use again.

- The internal memory of this product is set differently from the default format. Performing [Format] may enable you to use this product. Formatting will delete all data in the internal recording medium.

Data error.

- An error occurred during reading or writing the internal memory of this product.
- This may occur when you keep applying shock to this product.
- Movies recorded on other devices may not be played back.

The Image Database File is damaged. Do you want to create a new file?

HD movie management information is damaged. Create new information?

- The management file is damaged. When you select [Yes], a new management file is created. The old recorded images on the media cannot be played back (Image files are not damaged). If you execute [Repair Img. DB F.] after creating new information, playing back the old recorded images may become possible. If it does not work, copy the image using the PlayMemories Home software.

There is no Image Database File Movies cannot be recorded or played Create a new file?

There is no HD movie management information. Create new information?

- You cannot record or play back movies because no movie management information exists. If you select [Yes], new management information is created and you can record or play back movies.

Inconsistencies found in image database file. Do you want to repair the image database file?

The Image Database File is damaged. Do you want to repair the Image Database File?

Inconsistencies found in image database file. Cannot record or play HD movies. Do you want to repair the image database file?

- You cannot record or play back movies because no movie management information exists. If you select , new management information is created and you can record or play back movies.

Inconsistencies found in the image database file. Back up and recover.

Recover, then import using the included PC software.

- Since the database information of high definition image quality (HD) movies has been damaged, there are inconsistencies between the information in the database and the information in the file. Select to back up the high definition image quality (HD) movies and repair the database file. You cannot see the backed-up movies on this product. By connecting this product to a computer after repairing the database, you can import backed-up high definition image quality (HD) movies to the computer using the PlayMemories Home  software installed on the computer. However, it is not guaranteed that all movies can be imported to the

computer.

Buffer overflow. Writing to the media was not completed in time.

- You have performed recording and erasing operations repeatedly, or a memory card that has been formatted by other device is used. Copy and take data backup to other device (such as a computer), and then format the memory card on this product.
- The size of the inserted memory card is not sufficient for copying the movie(s). Use the recommended memory card.

Restoring data...

- Writing data onto the media of this product has failed. Attempts were made to recover the data, but they were unsuccessful.

Cannot recover data.

- Writing data onto the media of this product has failed. Attempts were made to recover the data, but they were unsuccessful.

Reinsert the memory card.

- Reinsert the memory card a few times. If the indicator continues to flash even after reinserting, the memory card could be damaged. Try with another memory card.

Cannot recognize this memory card. Format and use again.

- Format the memory card. Note that when you format the memory card, all the recorded movies and photos are deleted.

The maximum number of still image folders has been reached. Cannot record still images.

- You cannot create folders exceeding 999MSDCF. You cannot create or delete created folders using this product.
- Format the memory card, or delete folders using your computer.

This memory card may not be able to record or play movies.

This memory card may not be able to record or play images correctly.

- Use a memory card recommended for this product.

Do not eject the memory card during writing. Data may be damaged.

- Reinsert the memory card.

Others

Maximum number of images already selected.

- You can select only 100 images at one time for:
 - _Deleting movies/photos
 - _Protecting movies/photos, or releasing the protection
 - _Copying movies/photos

Data protected.

- You tried to delete protected data. Release the protection of the data.

Related Topic

 [Repair Img. DB F.](#)

 [Format](#)