

Measurement

Measurement

This chapter provides information related to the measurements done through E5061B.

- Setting Measurement Conditions
- Calibration
- Making Measurements
- Data Analysis
- Data Output
- Optimizing Measurements
- Measurement Examples

Setting Measurement Conditions

Setting Measurement Conditions

- Initializing Parameters
- Setting the System Z0
- Setting Channels and Traces
- Selecting Measurement Parameters
- Setting Stimulus Conditions
- Applying DC bias
- Selecting a Data Format
- Setting the Scales
- Setting Window Displays
- Setting Port Coupling

Initializing Parameters

The E5061B has three different initial settings as shown below.

Initial setting	Restore method
Preset state	Press Preset > OK the front panel or Execute the :SYST:PRES command
*RST state	Execute the *RST command
Factory default setting	E5061B factory (default) settings

The user can set items to be preset freely. For more information, see Setting the user preset function.

Other topics about Setting Measurement Conditions

Setting the System Z0

The procedure for setting the system characteristic impedance (Z_0) is as follows:

1. Press **Cal** key.
2. Click **Set Z0**, then input the system Z_0 .

Other topics about Setting Measurement Conditions

Setting Channels and Traces

- Overview of Channel and Trace
- Number of Channels Traces
- [Setting Channel Display \(Layout of Channels\)](#)
- [Setting Trace Display](#)
- [Active Channel](#)

Other topics about Setting Measurement Conditions

Overview of Channel and Trace

The E5061B allows you to setup multiple channels to perform measurement under different stimulus conditions.

As multiple traces (measurement parameters) can be displayed for each channel, no feature is provided to link the stimulus conditions between channels, and each channel is always independent of the others. In other words, you need to set the measurement conditions and execute calibration for each channel you use for measurement.

When you set items whose setting target is channels/traces (refer to [Parameter setting for each setup item](#)), the target is the selected (active) channel/trace. You can specify only the displayed channels/traces as active channels/traces. Therefore, set the display of channels/traces before setting the measurement conditions.

Setting Parameter for each Setup Item (Analyzer, Channel, Trace)

The following table lists the setting parameters and indicates the setup item (analyzer, channel, or trace) that each parameter controls along with the applicable setup key(s).

Parameter	Controlled Setup Items			Setup Key(s)
	Analyzer	Channel	Trace	
Stimulus Settings				
Sweep range		x		Start, Stop, Center, Span
Power, CW frequency		x		Sweep Setup > Power
Sweep time/Sweep delay time		x		Sweep Setup > Sweep Time, Sweep Delay

E5061B

Number of points		x		Sweep Setup > Points
Segment sweep		x		Sweep Setup > Sweep Type, Edit Segment Table, Segment Display
DC Bias		x		Sweep Setup > Sweep Type
Trigger Settings				
Trigger mode		x		Trigger > Hold/Single/Continuous
	x			Hold All Channels/Continuous Disp Channels
Trigger source, Trigger Event, Trigger Scope	x			Trigger > Trigger Source, Trigger Event, Trigger Scope
Trigger	x	-		Trigger > Restart/Trigger
Ext Trigger Input, Trigger Delay	x	-		Trigger > Ext Trig Input, Trigger Delay
Ext Trigger Output, Polarity, Position, Pulse Width	x	-		Trigger > Ext Trig Output, Polarity, Position, Pulse Width
Response Settings				
Measurement parameter			x	Meas
Data format			x	Format
Scale, Electrical delay, Phase offset			x	Scale
Memory trace and data math			x	Display > Display/Data-> Mem/Data Math

Equation Editor		x		Display > Equation Editor/Equation (ON/OFF)
Window title		x		Display > Edit Title Label/ Title Label (ON/OFF)
Graticule label in rectangular form		x		Display > Graticule Label (ON/OFF)
Color inversion	x			Display > Invert Color
Frequency display	x			Display > Frequency (ON/OFF)
Display update	x			Display > Update (ON/OFF)
Averaging		x		Avg > Averaging Restart/ Avg Factor/Averaging (ON/OFF)
Averaging Trigger	x			Avg > Avg Trigger (ON/OFF)
Smoothing			x	Avg > Smo Aperture/ Smoothing (ON/OFF)
IF bandwidth, IF BW Auto, IF BW Auto Limit		x		Avg > IF Bandwidth, IFBW Auto, IFBW Auto Limit
Calibration		x		Cal
System Impedance	x			Cal > Set Z0
Marker			x	Marker , Marker Search , Marker Fctn
Market Table	x			Marker Fctn > Marker Table
Analysis				
Time domain, Fault Location,			x	Analysis > Gating , Fault Location

SRL		x		Analysis > SRL
Parameter conversion			x	Analysis > Conversion
Limit test, Ripple Test, Bandwidth Test			x	Analysis > Limit Test, Ripple Test, Bandwidth Limit
Saving and recalling data	x			Save/Recall
Macro	x			Macro Setup, Macro Run, Macro Break
System				
Printing/Saving display Screen/Beeper/GPIB settings/Network Settings/Date & Time/Key Lock/Backlight/Firmware Revision/Service menu	x			System
Preset	x			Preset

Number of Channels/Traces

The number of channels and the number of traces are 4. The maximum number of points is 1601.

Setting Channel Display (Layout of Channels)

The measurement result for each channel is displayed in its dedicated window (channel window). You cannot have a single window to display the measurement results from more than one channel. This means that the setting of the window layout determines the number of channels displayed on screen.

NOTE The execution of measurement for each channel does not depend on how the channel is displayed (channels that are not displayed can be measured). For information on executing measurement for each channel (trigger mode and trigger source), refer to Making Measurements.

The procedure for setting the window layout is as follows:

1. Press **Display > Allocate Channels**.
2. Press the desired softkey to select the window layout.

Setting Trace Display

Setting the number of traces

Depending on the measurement parameters of the traces displayed for each channel, the sweep necessary for each channel is executed. For more information, refer to Sweep Order in Each Channel.

You specify the trace display by setting the number of traces (upper limit of displayed trace numbers). For example, if you set the number of traces to 3, traces 1 through 3 are displayed.

The procedure for setting the number of traces is as follows:

1. Press **Channel Next** (or **Channel Prev**) to select the channel for which you want to set the number of traces.
2. Press **Display** > **Number of Traces**.
3. Press the desired softkey to set the number of traces.

Setting trace layout (graph layout)

Traces are laid out and displayed in the order of the trace number from graph 1 according to the graph layout in the channel window.

You can select the graph layout from the windows layout.

If the number of traces is less than the number of graphs, nothing is displayed in the remaining area. If the number of traces you set exceeds the number of graphs, excess traces are superimposed from the first

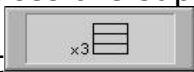
graph. For example, if you select  as the graph layout and set the number of traces to 4, graph 1 (Gr1 in [Graph layout](#)) display traces 1 and 4, respectively, by superimposing, and graph 2 (Gr2 in [Graph layout](#)) and graph 3 (Gr3 in [Graph layout](#)) displays trace 2 and trace 3 as shown in the figure below.

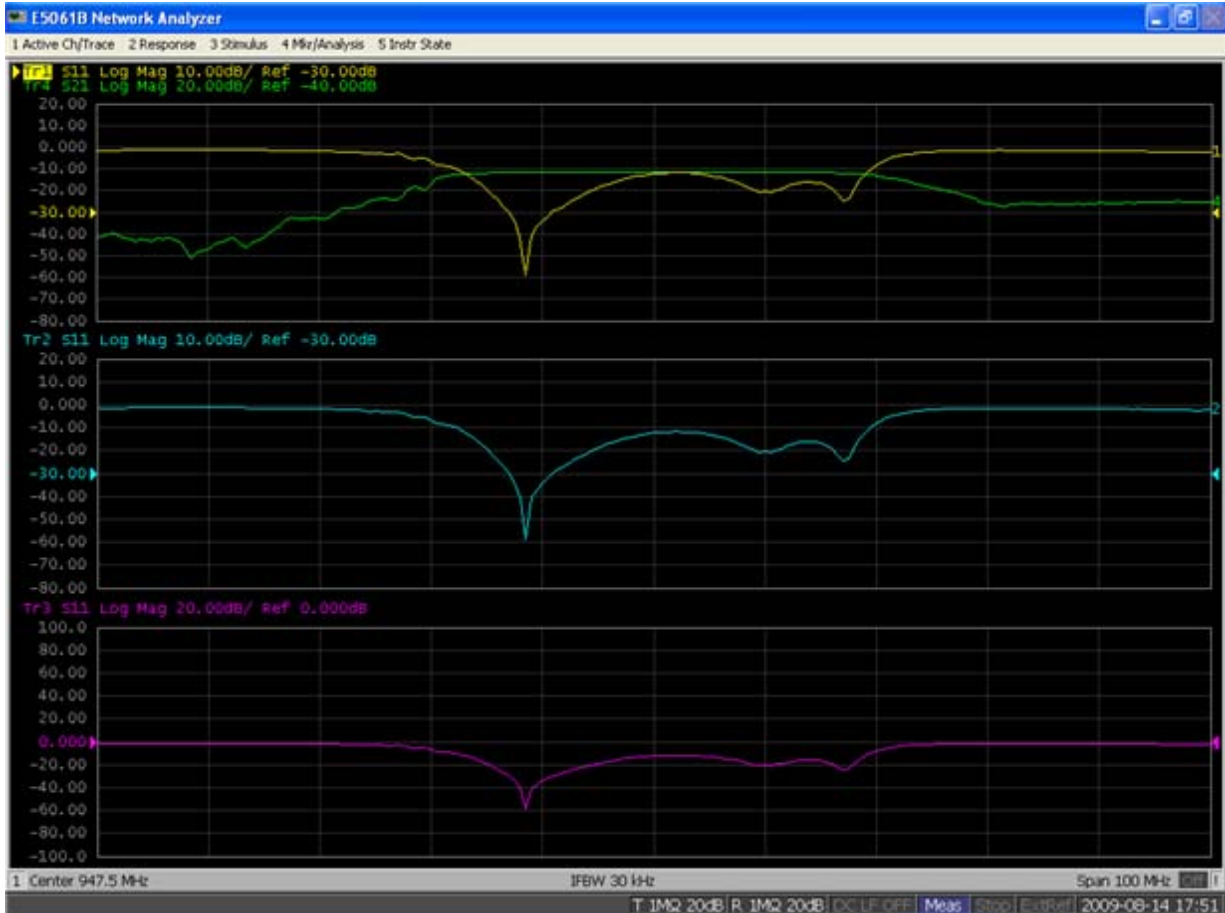

The procedure for setting the graph layout is as follows:

1. Press **Channel Next** (or **Channel Prev**) to select the channel for which you want to set the graph layout.
2. Press **Display** > **Allocate Traces**.
3. Press the desired softkey to select the graph layout shown below.

Graph Layout

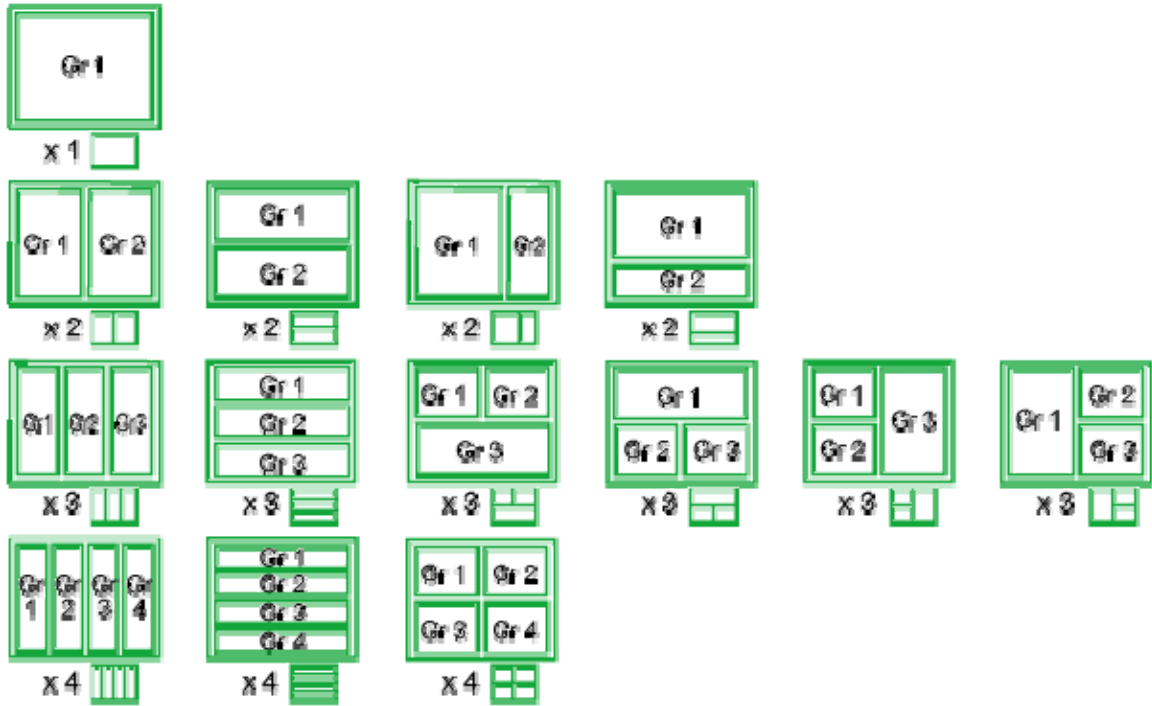

Active Channel

Active Channel

The active channel is the one whose settings can currently be changed. The window frame of the active channel is displayed brighter than the window frames of the other channels. To change the settings specific to a certain channel, you must first activate the channel.

To change the active channel, use the following hardkeys:

Hardkey	Function
Channel Next	Change the active channel to the next channel with the larger channel number.
Channel Prev	Change the active channel to the previous channel with the smaller channel number.

Active trace

The active trace is the one whose settings can currently be changed. The trace name on the screen (for example, Tr2) of the current active trace is highlighted and indicated with ► to the left. To change the settings specific to a certain trace, you must first activate the trace.

To select the active trace, use the following hardkeys:

Hardkey	Function
Trace Next	Change the active trace to the next trace with the larger trace number.
Trace Prev	Change the active trace to the previous trace with the smaller trace number.

Selecting Measurement Parameters

The E5061B allows users to evaluate the DUT (device under test) characteristics by using the following measurement parameters.

- Select Measurement Port
- S-parameters
- Absolute
- Gain-Phase

Other topics about Setting Measurement Conditions

Select Measurement Port (Option 3L5 Only)

For each channel, the measurement should select either S-parameter or Gain-Phase. This function is available only in option 3L5 (Gain-Phase).

1. Press **Meas** > **Measurement Port**.
2. Select **S-Parameter** or **Gain-Phase**.
3. All traces in the selected channel are set to either S11 or T/R, respectively.

NOTE By using the commands, the parameters of S-parameters (Sxx) and Gain-Phase (T/R, T, R) can exist in one channel. The **Measurement Port** softkey has no equivalent SCPI command.

S-parameters

S-parameters (scattering parameters) are used to evaluate how signals are reflected by and transferred through the DUT. An S-parameter is defined by the ratio of two complex numbers and contains information on the magnitude and phase of the signal. S-parameters are typically expressed as follows:

$$S_{\text{out in}}$$

out: port number of the DUT from which the signal is output

in: port number of the DUT to which the signal is input

For example, S-parameter S_{21} is the ratio of the output signal of port 2 on the DUT with the input signal of port 1 on the DUT, both expressed in complex numbers.

1. Press **Channel Next** (or **Channel Prev**) and **Trace Next** (or **Trace Prev**) to select the trace.

2. Select a softkey that corresponds to the desired measurement parameter. If the desired softkey is gray out, press **Meas** > **Measurement Port** > **S-Parameter**.

Absolute

Absolute shows the absolute power for reference and received signals on the port.

Softkey	Description
A (n)	Absolute measurement in Port 1, test receiver
B (n)	Absolute measurement in Port 2, test receiver
R1 (n)	Absolute measurement in Port 1, reference receiver
R2 (n)	Absolute measurement in Port 2, reference receiver

where n in the parentheses is the stimulus port number. For example, R1(1) means the reference level while the signal is output from the port 1, and A(2) means the received signal level into port 1 while the signal is output from the port 2.

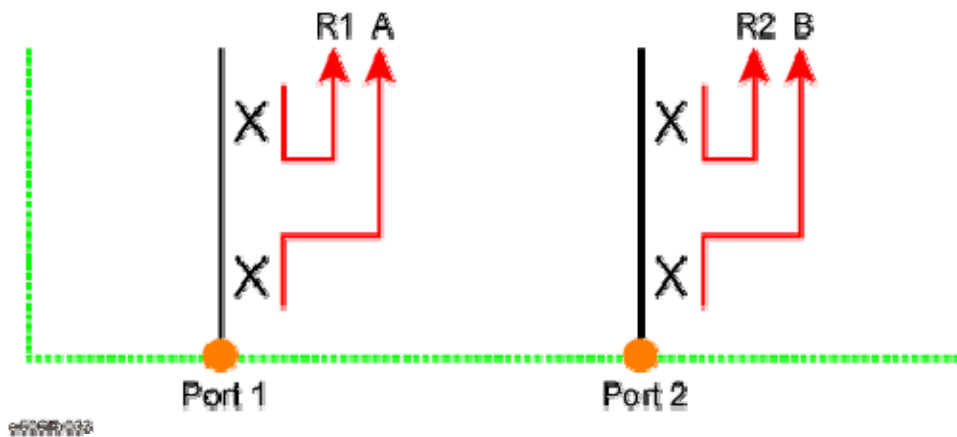

1. Press **Channel Next** (or **Channel Prev**) and **Trace Next** (or **Trace Prev**) to select the trace.
2. Press **Meas** > **Absolute**. If **Absolute** is gray out, press **Meas** > **Measurement Port** > **S-Parameter**.
3. Select a softkey that corresponds to the desired measurement parameter.

Gain-Phase (Option 3L5 Only)

1. Press **Channel Next** (or **Channel Prev**) to select the channel.
2. Press **Meas** > **Measurement Port** > **Gain-Phase**.
3. Press **Trace Next** (or **Trace Prev**) to select the trace.

4. Press **Meas** > **Gain-Phase**. Then select a softkey that corresponds to the desired measurement parameter.

Input Impedance

The input impedance can be selected from 50 Ω or 1 M Ω .

1. Press **Channel Next** (or **Channel Prev**) and **Trace Next** (or **Trace Prev**) to select the trace.
2. Press **Meas** > **Gain-Phase Setup** > **Input Impedance** > **R Input Z** (or **T Input Z**).
3. Select **50 Ω** or **1 M Ω** .

Input Attenuator

The input attenuator can be selected from 0 dB or 20 dB. When your input signal exceeds the signal over -5 dBm (50 Ω input) or 0.18 V_{peak} (1 M Ω input), the attenuator should be set at 20 dB.

1. Press **Channel Next** (or **Channel Prev**) and **Trace Next** (or **Trace Prev**) to select the trace.
2. Press **Meas** > **Gain-Phase Setup** > **Input Attenuator** > **R Attenuator** (or **T Attenuator**).
3. Select **0 dB** or **20 dB**.

Setting Stimulus Conditions

You can set the stimulus condition for each channel independently.

- Setting Sweep Type
- Setting Sweep Range
- Enable Stimulus Signal Output
- Setting Power Level
- Setting Fixed Frequency at Power/DC Bias Sweep
- Setting Number of Measurement Points
- Setting Sweep Delay and Sweep Time
 - Measuring in Time Series (Time Sweep)

Other topics about Setting Measurement Conditions

Setting Sweep Type

You can select the sweep type from the following four types.

SoftKey	Description
Linear Freq	Sweeps frequencies in linear scale.
Log Freq	Sweeps frequencies in logarithmic scale.
Segment	Performs a sweep with linear sweep conditions (segments) combined. For more information, refer to Performing a Segment-by-Segment Sweep (segment sweep).
Power Sweep	Sweeps power levels in linear scale.
DC Bias Sweep	Sweeps DC bias levels. This is available only when option is 3L5.

The procedure for selecting the sweep type is as follows:

1. Press **Channel Next** (or **Channel Prev**) to select the channel for which you want to set the sweep type.
2. Press **Sweep Setup** > **Sweep Type**.
3. Press the desired softkey to select the sweep type.

NOTE The time sweep is shown in Measuring in Time Series. This allows you to display the measurement parameter versus time.

Setting Sweep Range

There are two ways to set the sweep range: by specifying the lowest and the highest values and by specifying the center value and a span. Once the sweep range is set, it is possible to change the range by substituting the lowest value, the highest value, or the center value with a value (stimulus value) represented by a marker on the trace.

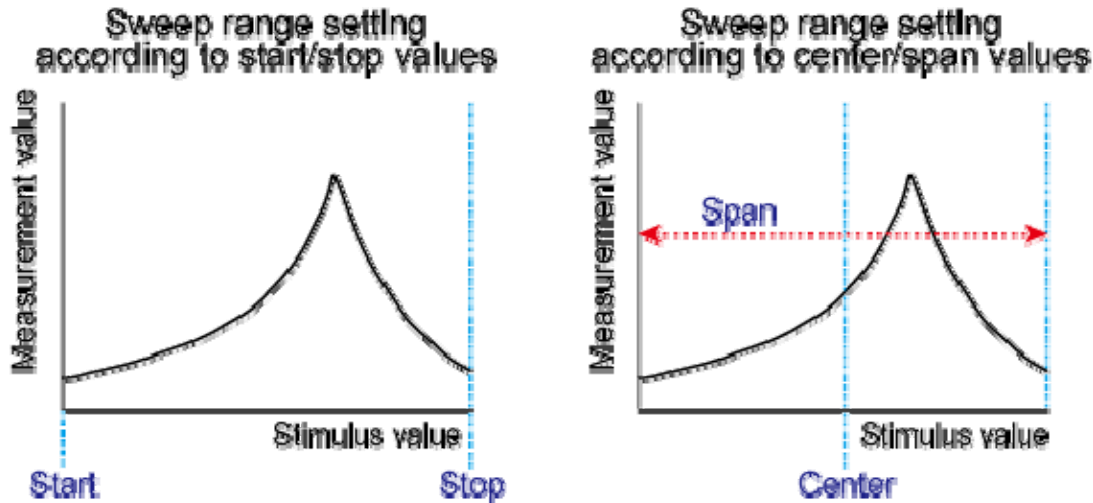

e5071e443

Setting the Sweep Range with the Lowest and Highest Values

1. Press **Channel Next** (or **Channel Prev**) to select the channel of which sweep range will be set.
2. Click **Start**, then input the lowest value.
3. Click **Stop**, then input the highest value.

Setting the Sweep Range with the Center Value and a Span

1. Press **Channel Next** (or **Channel Prev**) to select the channel of which sweep range will be set.
2. Click **Center**, then input the center value.
3. Click **Span**, then input the span value.

Setting Sweep Range Using the Marker

1. In the channel window of which range must be set, place the active marker on the active trace to a position that corresponds to the new range (to the lowest, highest, or center value).
2. Press **Marker Fctn**.
3. Click the **softkey** that corresponds to each value.

NOTE If the reference marker is on and the stimulus value of the active marker is expressed by a value relative to the reference marker, the absolute stimulus value will be used to set the new

E5061B

sweep rang.

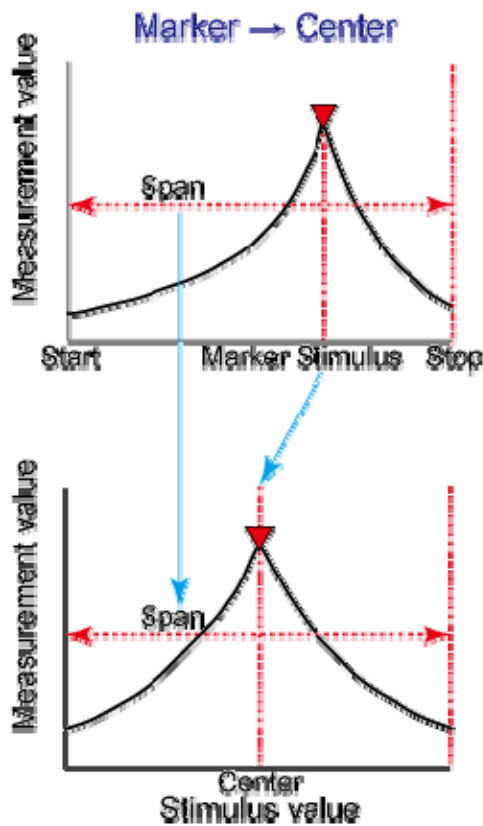
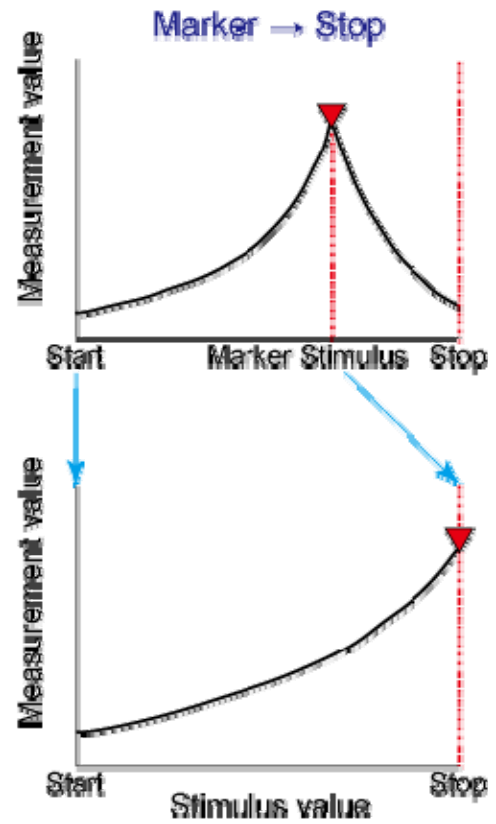
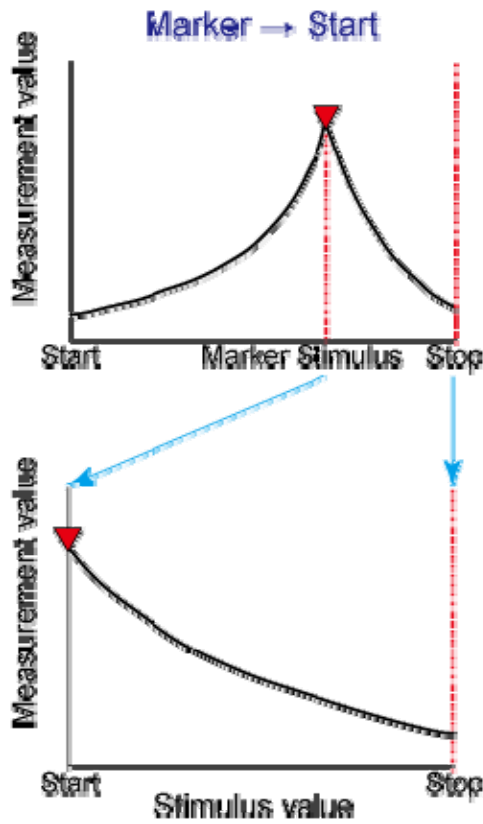

Enable Stimulus Signal Output

You can turn on/off the stimulus signal output, but this prevents you from performing the measurement. Therefore, normally this feature will not be used. This feature is mainly used to turn the output ON back after it has been turned OFF by the power trip feature.

Follow these steps to turn the stimulus signal output on/off:

1. Press **Sweep Setup**.
2. Click **Power > RF Out** (Each press toggles between on/off).

When set to OFF, "**RF OFF**" is displayed in Instrument Status Bar.

Power trip

The power trip is a feature that the instrument uses to automatically turn OFF the output of the stimulus signal to protect the instrument when a signal of which level exceeds the upper limit is inputted to the test port.

If the power output is automatically turned off by the power trip feature, remove the cause of the over-input and turn ON the power output according to the above steps to restart the measurement.

Setting Power Level

1. Press **Channel Next** (or **Channel Prev**) to select the desired channel.
2. Press **Sweep Setup** key.
3. Click **Power > Port Couple**, then select the **on/off setting** of the level coupling for all the ports.

NOTE

The power level of port 1 is coupled with the power level for all ports.

NOTE

If you change the on/off setting of the level coupling, all ports are automatically changed to the same level value as that of port 1.

4. Follow the procedure below according to the Port Couple.
 - When setting level for all ports (Port Couple ON)
 - a. Click **Power**, then enter the power level.
 - When setting level for each port (Port Couple OFF)
 - a. Press **Port Power**, then click the softkey corresponding to each port (**Port 1 Power**, **Port 2 Power**, **LF OUT Power**)
 - b. Enter the power level.

Correcting attenuation of power level (using power slope feature)

You can use the power slope feature to correct the attenuation of a power level so that it is simply proportional to the frequency (attenuation due to

cables and so on), which improves the accuracy of the level actually applied to the DUT.

Turning power slope feature on/off

1. Press **Channel Next** (or **Channel Prev**) to select the desired channel.
2. Press **Sweep Setup** key.
3. Click **Power > Slope [OFF] (Slope [ON])**. Each press toggles between on/off.

Setting correction coefficient (correction amount per 1 GHz)

1. Press **Channel Next** (or **Channel Prev**) to select the desired channel.
2. Press **Sweep Setup** key.
3. Click **Power > Slope [xxx dB/GHz]** ("xxx" represents the current set value.).
4. Enter the correction coefficient using the **ENTRY** block keys on the front panel.

Setting Fixed Frequency at Power/DC Bias Sweep

The procedure for setting the fixed frequency (CW frequency) at the power sweep and DC Bias sweep (Option 3L5 only) is as follows:

1. Press **Channel Next** (or **Channel Prev**) to select the desired channel.
2. Press **Sweep Setup** key.
3. Click **CW Freq**, then enter the fixed frequency.

Setting Number of Measurement Points

The number of points is the number of data items collected in one sweep. It can be set to any number from 2 to 1601 for each channel independently.

- To obtain a higher trace resolution against the stimulus value, choose a larger value for the number of points.
 - To obtain higher throughput, keep the number of points to a smaller value within an allowable trace resolution.
 - To obtain higher measurement accuracy after calibration, perform calibration using the same number of points as in actual measurements.
1. Press **Channel Next** (or **Channel Prev**) to select the desired channel.
 2. Press **Sweep Setup** key.
 3. Click **Points**, then input the desired number of points.

Setting Sweep Delay and Sweep Time

Sweep time is the time taken to complete a sweep for each stimulus (source) port. Two modes are available for setting the sweep time: manual sweep time mode and automatic sweep time mode.

Sweep Time Mode	Description
Manual	In this mode, the sweep time is set manually. Once the sweep time is set, changes in the measurement conditions do not affect the sweep time as long as it is within the analyzer's capability. If the sweep time becomes lower than the analyzer's lower sweep time limit, the sweep time is reset to the shortest time within the conditions. If the sweep time exceeds the analyzer's upper sweep time limit, the sweep time is reset to the longest time within the conditions.
Auto (Default)	The sweep time is always kept to the shortest time possible with the current measurement conditions.

The following figure shows the definitions of the sweep time and the sweep delay time.

Sweep delay is time before starting a sweep for each stimulus (source) port. Sweep time does not include the sweep delay.

Timing Chart for Sweep

When the trigger mode is set at "On Sweep".

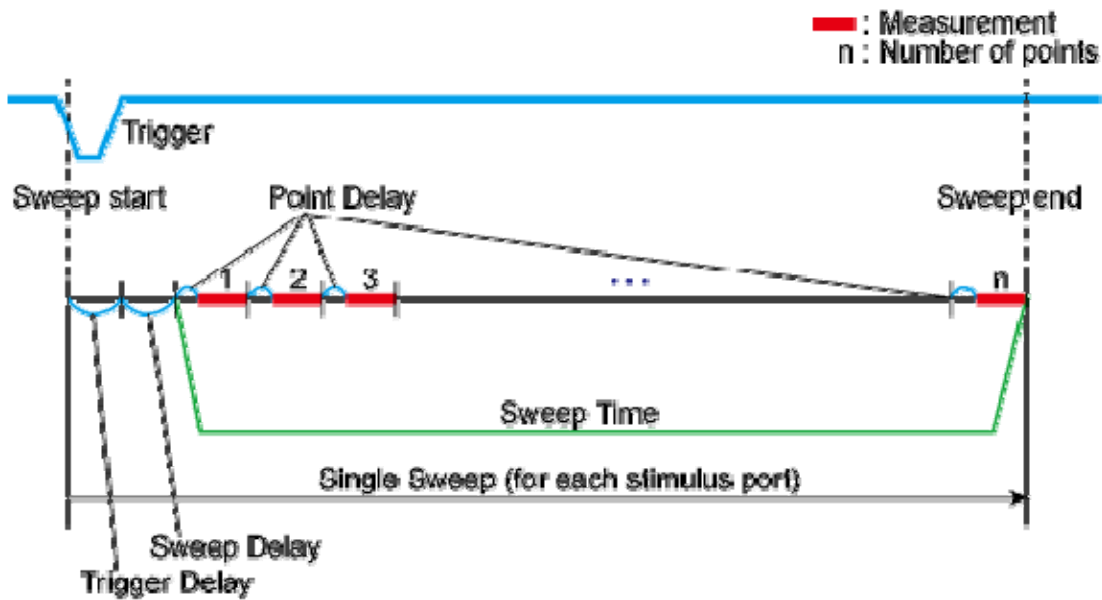

a5061b034

When the trigger mode is set at "On Point".

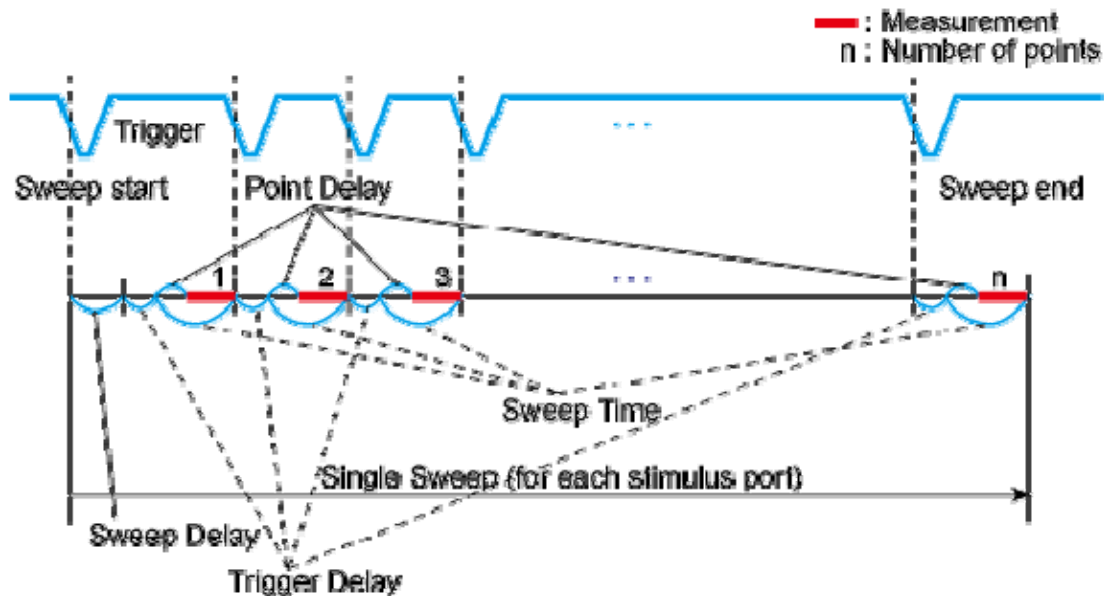

e5061b035

NOTE

Trigger delay is available when the trigger source is set at external.
 Sweep time is the total of point delay and measurement time in all measurement points when the trigger mode set at "On Point".

Setting Sweep Delay Time

1. Press **Channel Next** (or **Channel Prev**) to select the desired channel.
2. Press **Sweep Setup** > **Sweep Delay**.
3. Using the **ENTRY** block keys on the front panel, input the desired sweep delay time (in seconds).

Setting Up Sweep Time (Manual Sweep Time Mode)

1. Press **Channel Next** (or **Channel Prev**) to select the desired channel.
2. Press **Sweep Setup** > **Sweep Time Auto** to turn OFF.
3. The softkey named **Sweep Time** is activated. Press **Sweep Time**.
4. Using the **ENTRY** block keys on the front panel, input the desired sweep time (in seconds).

NOTE

The sweep time is not correctly displayed in DC Bias sweep at 90 kHz and above when there are the traces for both Gain-Phase and S-Parameter measurements in one channel.

Measuring in Time-Series (Time Sweep)

The following procedure allows you to time sweep and the measurement parameter is displayed versus time.

1. Press **Channel Next** (or **Channel Prev**) to select the channel of which sweep range will be set.
2. Press **Span** > **0** > **x1** to set the span value to 0 (zero span).
3. Press **Center**, then input the desired value (frequency, power, or DC bias).
4. Press **Sweep Setup** > **Sweep Time Auto** to turn OFF.
5. Press **Sweep Time**, then input the duration of the sweep which is displayed on X-axis.
6. Press **Marker** to display the marker 1. The time at the marker shows as the marker position value at the upper left corner on the screen.

Applying DC bias and DC Source (Option 3L5 only)

- Overview
- Setting DC Bias
- Applying DC Bias
 - Using as DC Source

Other topics about Setting Measurement Conditions

Overview

E5061B option 3L5 allows you to apply the DC bias on the source signal of Port 1 or LF output port. The range of DC bias is -40 V to +40 V.

DC Source

When you make S-parameter measurements, the LF output port can be used as the DC supply.

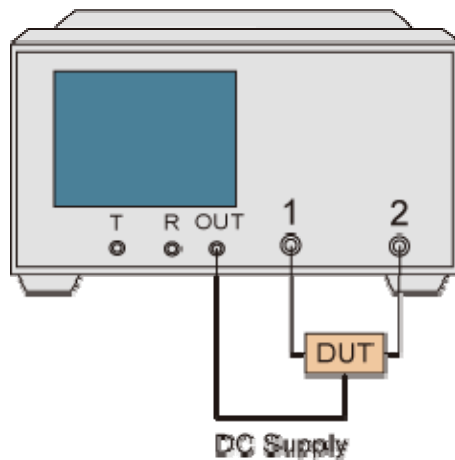

e5061b052

Setting DC Bias

1. Press **Sweep Setup** > **DC Bias Port**, then select **LF Out** or **Port 1** which you want to output the DC bias to.
2. Press **DC Bias Level**, then enter the DC bias level.

Applying DC Bias

1. Press **Sweep Setup** > **DC Bias** to turn it ON.

When an ECal is connected to the E5061B USB port or **Cal** > **Calibrate** is pressed, DC Bias is turned OFF in order to avoid the calibration kit having damage.

Using as DC Source

1. Setup the S-Parameter measurements.
2. Press **Sweep Setup** > **DC Bias Port** > **LF Out**.

E5061B

3. Press **DC Bias Level**, then enter the DC level.
4. Press **DC Bias** to turn ON.
5. Make the S-Parameter measurements.

Selecting a Data Format

The E5061B allows you to display the measured S-parameters by using the following data formats. The data format can be preset to factory settings using the Preset option.

- Rectangular display formats
- Polar format
- Smith chart format

Other topics about Setting Measurement Conditions

Rectangular display formats

Rectangular display formats draw traces by assigning stimulus values (linear scale) to the X-axis and response values to the Y-axis. Eight different formats are available depending on the selection of data for the Y-axis.

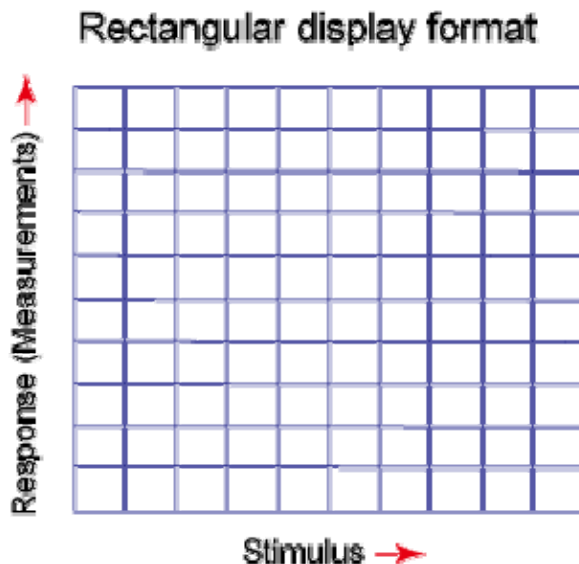

e5071e451

Type	Y-axis Data Type	Y-axis Unit	Application Examples
Log magnitude format	Magnitude	dB	<ul style="list-style-type: none"> • Return loss measurement • Insertion loss measurement (or gain measurement)
Phase	Phase (displayed in range from -180°)	Degrees (Measurement of deviation

format	to +180 °)	°)	from linear phase
Expanded phase format	Phase (can be displayed above +180 ° and below -180 °)	Degrees (°)	Measurement of deviation from linear phase
Positive phase format	Phase (displayed in range from 0 ° to +360 °)	Degrees (°)	Measurement of deviation from linear phase
Group delay format	Signal transfer delays within the DUT	Seconds (s)	Group delay measurement
Linear magnitude format	Magnitude	(Abstract number)	Reflection coefficient measurement
SWR format	$\frac{1 + \rho}{1 - \rho}$ (ρ : reflection coefficient)	(Abstract number)	Measurement of standing wave ratio
Real format	Real part of measured complex parameter	(Abstract number)	
Imaginary format	Imaginary part of the measured complex parameter	(Abstract number)	

Polar format

In the polar format, traces are drawn by expressing the magnitude as a displacement from the origin (linear) and phase in an angle counterclockwise from the positive X-axis. This data format does not have a stimulus axis, so frequencies must be read by using the marker. The polar format allows users to select one of the following three data groups to display the marker response values.

- Linear magnitude and phase (°)
- Log magnitude and phase (°)

- Real and imaginary parts

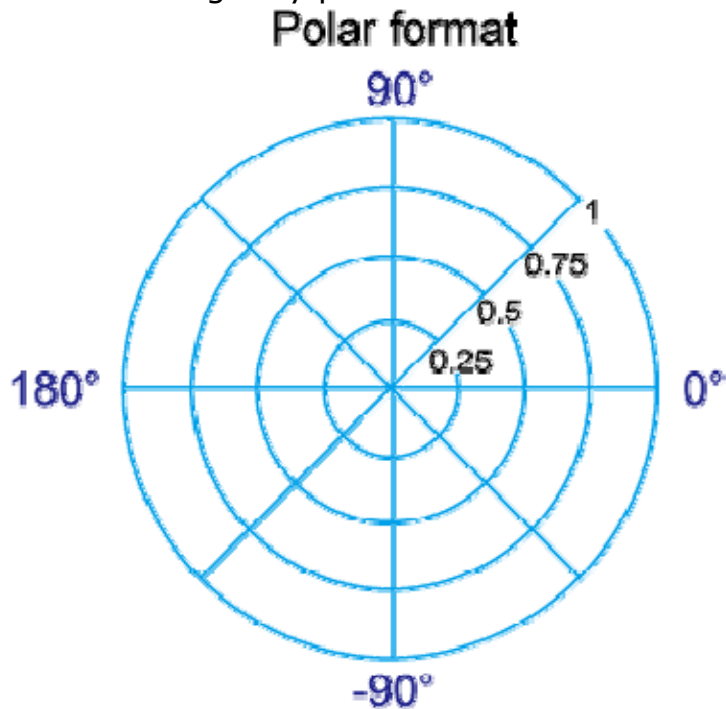

e5071c382

Smith chart format

The Smith chart format is used to display impedances based on reflection measurement data of the DUT. In this format, traces are plotted at the same spots as in the polar format. The Smith chart format allows users to select one of the following five data groups to display the marker response values.

- Linear magnitude and phase (°)
- Log magnitude and phase (°)
- Real and imaginary parts
- Resistance (ohm), Reactance (ohm), and inductance (H) or capacitance (F)
- Conductance (S), susceptance (S), and capacitance (F) or inductance (H)

Smith chart format

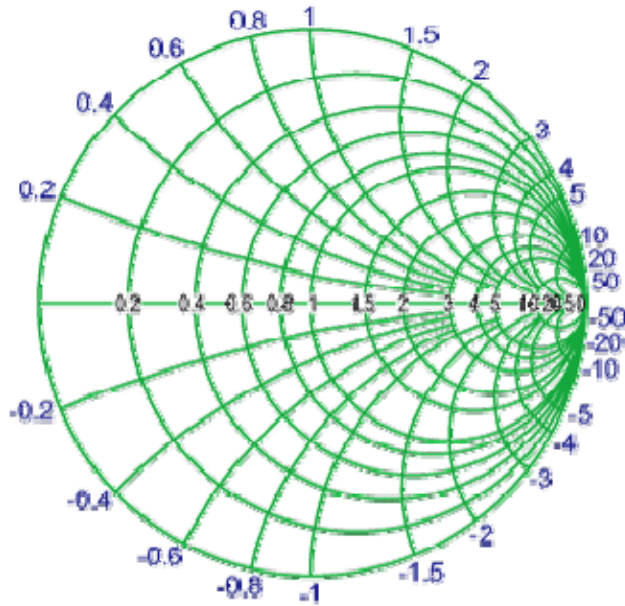

e5071c383

Use the following procedure to select a data format:

1. Press **Channel Next** (or **Channel Prev**) and **Trace Next** (or **Trace Prev**) to select the trace for which the data format will be set.
2. Press **Format**.
3. Press the softkey that corresponds to the desired data format.

Softkey	Function
Log Mag	Selects the log magnitude format
Phase	Selects the phase format
Group Delay	Selects the group delay format
Smith > Lin / Phase	Selects the Smith chart format (with linear magnitude and phase as the marker response values)
Smith > Log / Phase	Selects the Smith chart format (with log magnitude and phase as the marker response)

	values)
Smith > Real / Imag	Selects the Smith chart format (with the real and imaginary parts as the marker response values)
Smith > R + jX	Selects the Smith chart format (with resistance and reactance as the marker response values)
Smith > G + jB	Selects the Smith chart format (with conductance and susceptance as the marker response values)
Polar > Lin / Phase	Selects the polar format (with linear magnitude and phase as the marker response values)
Polar > Log / Phase	Selects the polar format (with log magnitude and phase as the marker response values)
Polar > Real / Imag	Selects the polar format (with the real and imaginary parts as the marker response values)
Lin Mag	Selects the linear magnitude format
SWR	Selects the SWR (standing wave ratio) format
Real	Selects the real format
Imaginary	Selects the imaginary format
Expand Phase	Selects the expanded phase format
Positive Phase	Selects the positive phase format

Setting the Scales

- Auto Scale
- Manual Scale Adjustment
- Setting Reference Line Value Using Marker

Other topics about Setting Measurement Conditions

Auto Scale

The auto scale function is used to tailor each scale (scale/division and the reference line value) automatically in such a way that traces will appear at the proper size on the screen for easy observation.

NOTE The scale data can be preset to factory settings using the Preset option.

Single Trace Auto Scale

Follow the procedure below to perform the auto scale function on a specific trace.

1. Press **Channel Next** (or **Channel Prev**) and **Trace Next** (or **Trace Prev**) to select the trace of which the auto scale function will be performed.
2. Press **Scale > Auto Scale**.

Auto Scale on All Traces Within a Channel

1. Press **Channel Next** (or **Channel Prev**) to select the channel of which the auto scale function will be performed.
2. Press **Scale > Auto Scale All**.

Manual Scale Adjustment

Manual scale adjustment on the rectangular display format

For a rectangular display format, four parameters are used to manually adjust the scales.

Adjustable feature	Description
Divisions	Defines the number of divisions on the Y-axis. An even number from 4 to 30 must be used. Once set, it is commonly applied to all traces displayed in any rectangular format within that channel.
Scale/Division (Scale/Div)	Defines the number of increments per division on the Y-axis. The value applies only to the active trace.
Reference	Defines the position of the reference line. The position must

position	be specified using the number assigned to each division on the Y-axis starting at 0 (the least significant) running up to the number of divisions being used (the most significant). The position applies only to the active trace.
Reference line value (Reference Value)	Defines the value corresponding to the reference line. It must be set using the unit on the Y-axis. The reference line value applies only to the active trace.

Rectangular display format

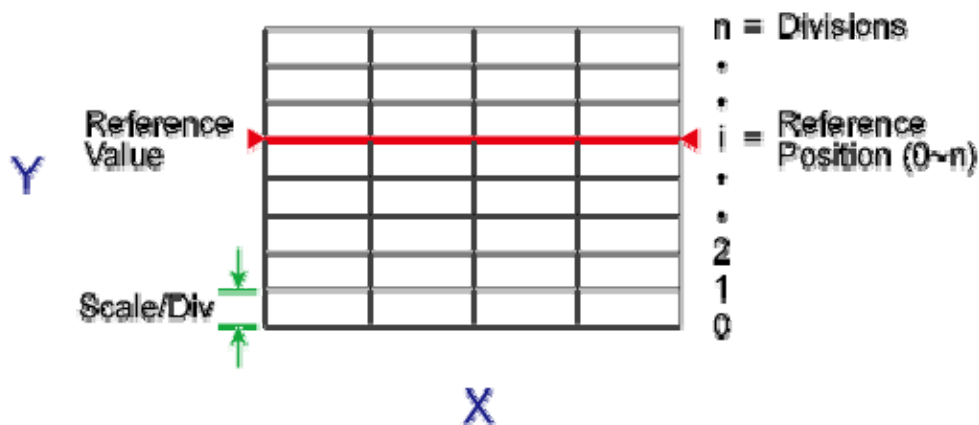

e5071c385

1. Press **Channel Next** (or **Channel Prev**) and **Trace Next** (or **Trace Prev**) to select the trace of which scale features will be adjusted.
2. Press **Scale**.
3. Select the **softkey** that corresponds to the particular feature that needs to be adjusted.

NOTE

It is also possible to turn off the display of graticule labels. For details, refer to Turning off the display of graticule labels.

Manual scale adjustment on the Smith chart/polar format

Manual scale adjustment on the Smith chart format or the polar format is done by using the displacement (**Scale/Div** of the outermost circle).

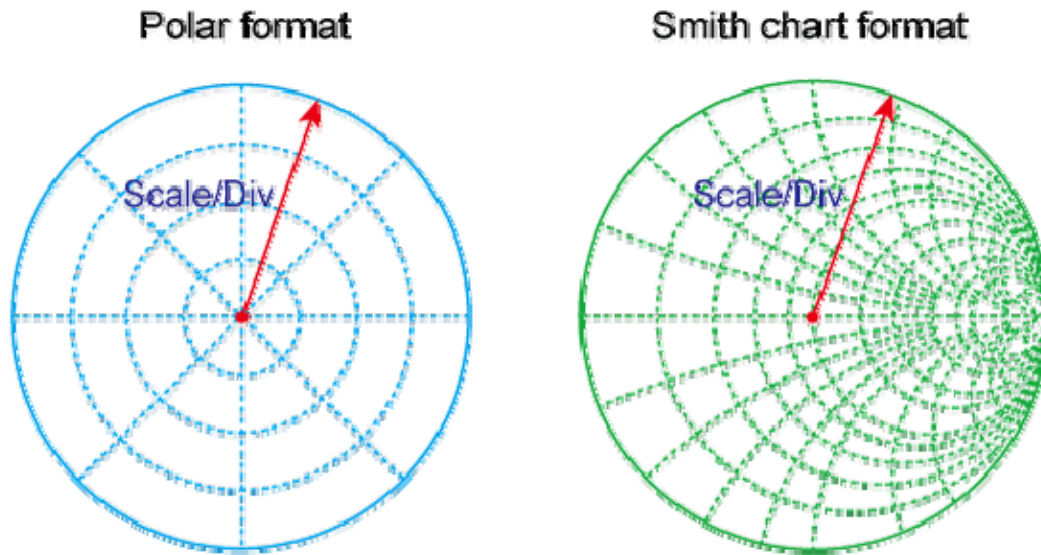

e5071e384

1. Press **Channel Next** (or **Channel Prev**) and **Trace Next** (or **Trace Prev**) to select the trace for which the scale will be adjusted.
2. Press **Scale**.
3. Click **Scale/Div**, then input the displacement of the outermost circle.

Setting Reference Line Value using Marker

When using a rectangular display format, it is possible to change the reference line value to be equal to the response value of the active marker on the active trace.

1. Place the active marker on the active trace on the position that corresponds to the new reference line value.
2. Press **Scale** or **Marker Fctn**.
3. Click **Marker -> Reference** to change the reference line value to the marker response value.

NOTE

If the reference marker is ON and the stimulus value of the active marker is expressed using a value relative to the reference marker, the absolute stimulus value is used to set the new reference line value.

Setting Window Displays

- Maximizing the specified window trace display
- Turning off the display of graticule labels
- Hiding Frequency Information
- Labeling a Window
- Setting display colors
- Setting display magnification
- [Resizing the screen](#)

Other topics about Setting Measurement Conditions

Maximizing the specified window/trace display

When using multiple channels, it is possible to maximize a specific channel window on the screen. When multiple traces are displayed in a channel window, it is also possible to maximize a specific trace displayed within that channel window.

NOTE

The Window/Trace Display data can be preset to factory settings using the Preset option

Maximizing a window

1. Press **Channel Next** (or **Channel Prev**) to select the channel of which window will be maximized.
2. Press **Channel Max** to maximize the channel window.
3. Press **Channel Max** one more time to reduce the window to its previous size.

Maximizing a trace display

1. Press **Channel Next** (or **Channel Prev**) to select the channel to which the trace belongs.
2. Press **Trace Next** (or **Trace Prev**) to select the trace of which display will be maximized.
3. Press **Trace Max** to maximize the trace display.
4. Press **Trace Max** one more time to reduce the display to its previous size.

Turning off the display of graticule labels

When using a rectangular display format, the graph area can be expanded to the left by turning OFF the display of graticule labels.

Turning OFF graticule label display

1. Press **Channel Next** (or **Channel Prev**) to select the channel of which graticule label display will be turned ON or OFF.
2. Press **Display**.
3. Click **Graticule Label** to turn graticule label display ON or OFF.

Hiding frequency information

You can hide the frequency information from the screen in order to ensure its confidentiality or for other reasons.

Hiding Frequency Information on the Screen

Follow the steps below to hide frequency information on the measurement screen.

1. Press **Display** key.
2. Click **Frequency** to turn OFF the frequency display.

NOTE

Turning OFF the frequency display using **Display** > **Frequency** key does not erase the frequency display within the **Stimulus** softkey, which is turned on by pressing **Start**, **Stop**, **Center**, and **Span**. The display of the softkey bar itself can be switched ON or OFF by pressing **Softkey On/Off**.

Hiding Softkey's Frequency Information

You can delete the frequency information from the measurement screen, which changes the frequency information displayed in the Stimulus softkey and the data entry area for Hz unit to asterisks (***)

1. Press **System** key.
2. Click **Service Menu**, then click **Security Level** and select any of the following options for the frequency display.

Softkey	Function
None	Displays the frequency information.
Low	Hides the frequency information with a series of asterisks. Save/Recall > Save Trace Data and Save SnP are inactive. This can be turned OFF by the Security Level menu.
High	Hides the frequency information with a series of asterisks. Save/Recall > Save Trace Data and Save SnP are inactive. This cannot be turned OFF by the Security Level menu. Resetting to OFF is only possible by executing Preset or Recall.

Labeling a window

It is possible to assign a unique name to a channel and display it on the screen. This feature is useful in saving and/or printing measurement results for future reference.

Labeling a window

1. Press **Channel Next** (or **Channel Prev**) to select the channel to be labeled.
2. Press **Display** > **Edit Title Label**, and the title label input dialog box appears.



3. Using the keys in the dialog box, type a label and click **Enter**.
4. Click **Title Label** to turn ON the title display. The title appears within a frame at the top of the channel window.

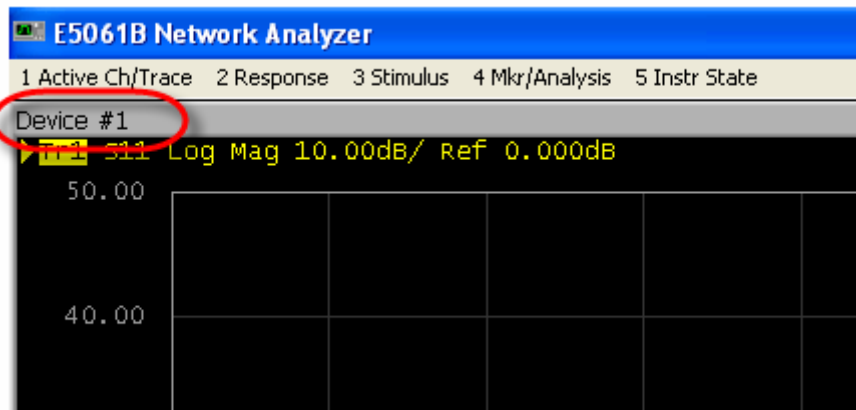

Setting display colors

Selecting display mode

You can select the display mode of the LCD display from two modes: normal display (background: black) or inverted display (background: white). In normal display, the colors of items are preset so that you can recognize them easily on the display of the instrument. On the other hand, in inverted display, they are preset to colors obtained by inverting the default settings to the normal display so that you can use data easily when storing it into a graphic file.

The selection procedure is as follows:

1. Press **Display**.

- Click **Invert Color** to select the display color. OFF indicates the normal display; ON the inverted display.

Setting display color for each item

You can set the display color to the normal display or inverted display separately for each of the following items:

- Data/memory trace
- Labels and lines of graphs
- File display of the limit test and limit lines
- Background

Set the color of each item by specifying the amounts of red (R), green (G), and blue (B) contained in the color. You can specify each level of R, G, and B in 6 steps (0 to 5). Therefore, total of 216 colors are available by combining them. The table below shows the R, G, and B values for the main colors as a reference.

	R	G	B		R	G	B		R	G	B
White	5	5	5	Gray	2	2	2	Black	0	0	0
Light red	5	3	3	Red	5	0	0	Dark Red	2	0	0
Light yellow	5	5	3	Yellow	5	5	0	Dark Yellow	2	2	0
Light green	3	5	3	Green	0	5	0	Dark Green	0	2	0
Light cyan	3	5	5	Cyan	0	5	5	Dark cyan	0	2	2
Light blue	3	3	5	Blue	0	0	5	Dark Blue	0	0	2
Light magenta	5	3	5	Magenta	5	0	5	Dark Magenta	2	0	2

The setting procedure is as follows:

- Press **System** > **Misc Setup** > **Display Setup** > **Color Setup**.
- Click **Normal** (for normal display) or **Invert** (for inverted display).
- Click the **softkey** corresponding to the item of which you want to set the display color.

4. Click **Red** (or, **Green**, or **Blue**).
5. Select the amount of the selected color from 0 to 5.

Resetting the display colors to the factory state

You can reset the display colors in normal display and inverted display to the preset factory state.

The selection procedure is as follows:

1. Press **System** > **Misc Setup** > **Display Setup** > **Color Setup**.
2. Click **Normal** (for normal display) or **Invert** (for inverted display).
3. Click **Reset Color** > **OK**.

Setting display magnification

You can reset the display magnification to Small, Normal or Large.

The selection procedure is as follows:

1. Press **System** > **Misc Setup** > **Display Setup** > **Magnification**.
2. Click **Normal**, **Small** or **Large**.

Resizing the screen

You can resize the E5061B screen by minimizing, maximizing or restoring it to its original size.

The resizing procedure is as follows:

1. Click **Resize E5061B** at the top right corner of the screen.



2. A drop-down menu prompts and the available options are:

Softkey	Function
Restore	Restores the screen to its default size.
Minimize	Minimizes the screen.
Maximize	Displays the screen in full page size.

3. Click **Restore**, **Minimize** or **Maximize**.

E5061B

4. When the screen is resized according to an option, its the related softkey is disabled. For example, when the screen is displayed in full page size, **Maximize** is disabled.

Another option to minimize the E5061B screen is by using the Menu Bar and the procedure is as follows:

1. Press **Display**.
2. Click **Minimize E5061B**.

You can also hide and restore the title bar of the E5061B screen and the procedure is as follows:

1. Press **Display**.
2. Click **E5061B Title bar**.
3. Click **ON** to restore the title bar.
4. Click **OFF** to hide the title bar.

Setting Port Coupling (Option 3L5 only)

In Option 3L5, Port 1 and 2 can be selectively AC or DC coupled. DC coupling (Default setting) allows both DC and AC signals through, while AC coupling accepts only AC signal. In DC coupling, the port 1 and 2 has 50 Ω input impedance. In AC coupling, a blocking capacitor is inserted at the ports 1 and 2. It may cause the signal level difference between AC and DC coupling at lower frequency.

1. Press **System** > **S-Param Port Couple**, then select **AC** or **DC**.

When the port coupling is set at AC, there are limitations as follows:

- DC bias can not be turned ON for the port 1.
- The minimum frequency is 100 kHz.

NOTE

When the port coupling is set at AC and the frequency is set below 100 kHz, the trigger becomes hold state.

Calibration

Calibration

Overview

- Measurement Errors and their Characteristics
- Calibration Types and Characteristics
- Checking Calibration Status
- Clear Calibration

Basic Calibration

- Selecting Calibration Kit
- OPEN/SHORT Response Calibration (reflection test)
- THRU Response Calibration (transmission test)
- Enhanced Response Calibration
- 1-Port Calibration (reflection test)
- Full 2-Port Calibration

Calibration with ECal (Electronic Calibration)

- ECal (Electronic Calibration)
- ECal Driver Installation
- Calibration Using ECal Module

Advanced Calibration with ECal

- Improving Calibration Accuracy along with ECal
- Confidence Check on Calibration Coefficients Using ECal
- Turning off ECal Auto-detect Function
- User-characterized ECal

Advanced Calibration

- Modifying Calibration Kit Definition
- Partial Overwrite
- Adapter Removal-Insertion

Measurement Errors and their Characteristics

- [Overview](#)
- [Drift Errors](#)
- [Random Errors](#)
- [Systematic Errors](#)

Other topics about Calibration

Overview

It is important to understand the factors contributing to measurement errors in order to determine the appropriate measures that should be taken to improve accuracy. Measurement errors are classified into three categories:

Drift Errors

Drift errors are caused by deviations in the performance of the measuring instrument (measurement system) that occur after calibration. Major causes are the thermal expansion of connecting cables and thermal drift of the frequency converter within the measuring instrument. These errors may be reduced by carrying out frequent calibrations as the ambient temperature changes or by maintaining a stable ambient temperature during the course of a measurement.

Random Errors

Random errors occur irregularly in the course of using the instrument. Since random errors are unpredictable, they cannot be eliminated by calibration. These errors are further classified into the following sub-categories depending on their causes:

- Instrument noise errors
- Switch repeatability errors
- Connector repeatability errors

Instrument noise errors

Instrument noise errors are caused by electric fluctuations within components used in the measuring instrument. These errors may be reduced by increasing the power of the signal supplied to the DUT, narrowing the IF bandwidth, or enabling sweep averaging.

Switch repeatability errors

Switch repeatability errors occur due to the fact that the electrical characteristics of the mechanical RF switch used in the measuring instrument change every time it is switched on. These errors may be reduced by carrying out measurements under conditions in which no switching operation takes place.

Connector repeatability errors

Connector repeatability errors are caused by fluctuations in the electrical characteristics of connectors due to wear. These errors may be reduced by handling connectors with care.

Systematic Errors

Systematic errors are caused by imperfections in the measuring instrument and the test setup (cables, connectors, fixtures, etc.). Assuming that these errors are repeatable (i.e., predictable) and their characteristics do not change over time, it is possible to eliminate them mathematically at the time of measurement by determining the characteristics of these errors through calibration. There are six types of systematic errors, as follows.

Errors caused by signal leaks in the measuring system:

- Directivity
- Isolation (cross-talk)

Errors caused by reflections in the measuring system:

- Source match
- Load match

Errors caused by the frequency response of the receiver within the measuring instrument:

- Reflection tracking
- Transmission tracking

The E5061B has two receivers for each S-parameter test port: the reference receiver and the test receiver (transmission measurement or reflection measurement). You can perform measurements with both of these receivers at the same time.

E5061B port architecture and systematic errors in S-parameter Measurement

S Parameter

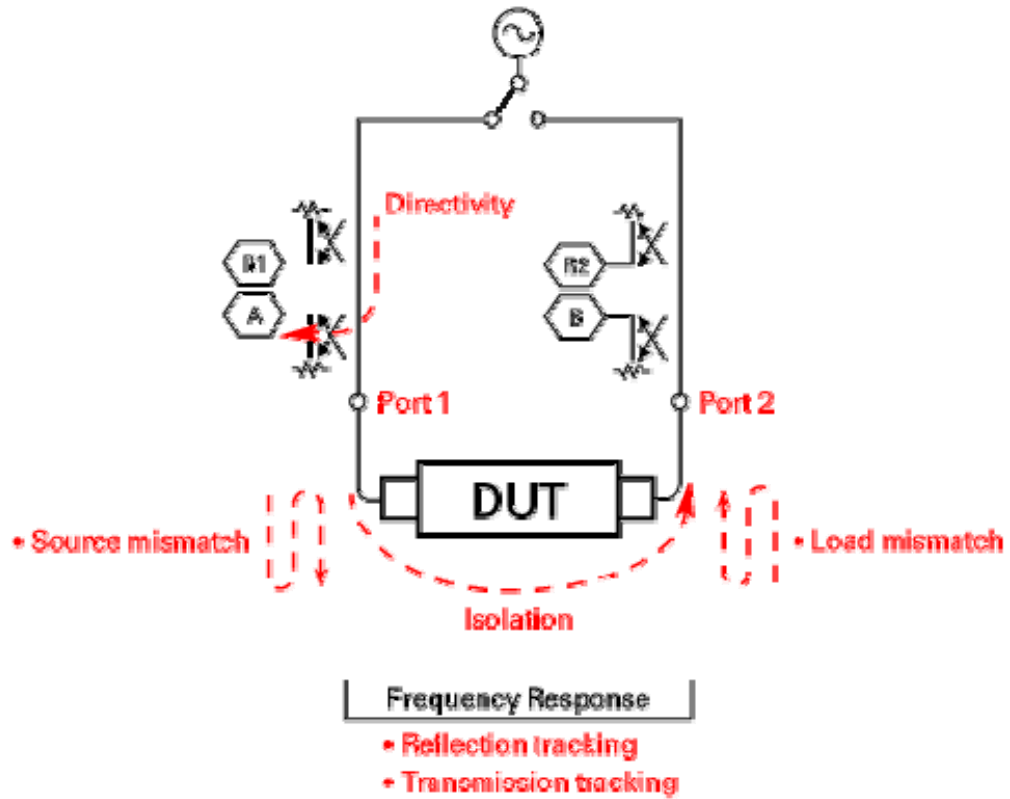

a5061b/002

The ports T and R are receivers and LF out supplies the source signal.
E5061B port architecture and systematic errors in Gain-Phase Measurement

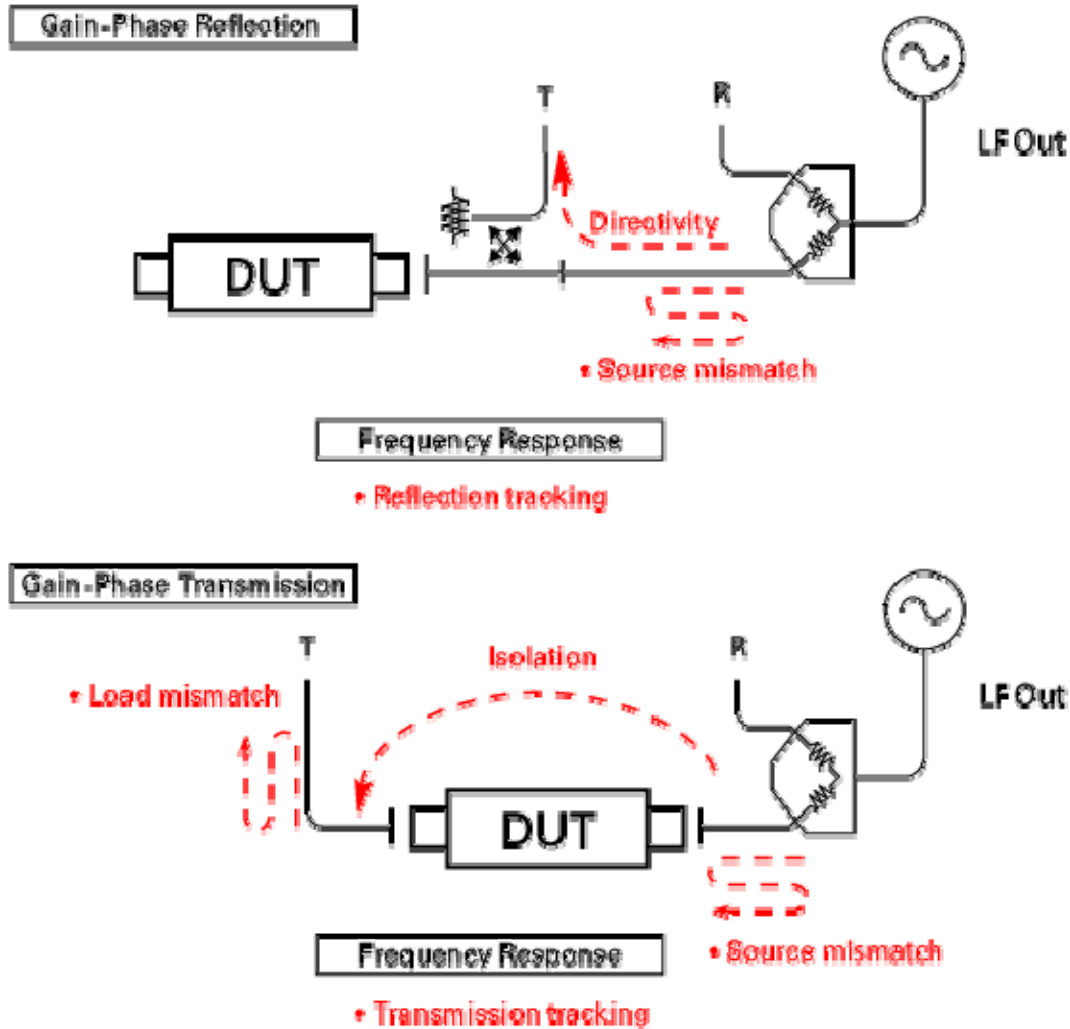

E5061B

Directivity error (Ed)

Directivity errors are caused by the fact that, in a reflection measurement, signals other than the reflection signal from the DUT are received by the receiver through the directivity coupler. When a certain port is a stimulus port, this error can be defined as a constant value for each stimulus port because the state of the termination at the other ports does not change. The number of directivity errors of the E5061B is the number of stimulus ports you use.

Isolation error (Ex)

An isolation error (crosstalk error) is caused by signals other than the transmission signal of the DUT leaking to the test receiver of the transmission measurement port in transmission measurements. When a certain port is a stimulus port, an isolation error is defined for each of the ports. Therefore, the number of isolation errors for the E5061B is the total number of combinations of stimulus ports and response ports.

Source match error (E_s)

A source match error is caused when the reflection signal of the DUT reflects at the signal source and enters the DUT again. When a certain port is a stimulus port, this error can be defined as a constant value for each stimulus port because the state of the signal source switch does not change. The number of source match errors in the E5061B is equivalent to the number of stimulus ports you use.

Load match error (E_l)

A load match error is caused when part, but not all, of the signal transmitted in the DUT reflects at a response port is measured by the receiver of the response port. When a certain port is a stimulus port, a load match error is defined for each of the ports. Therefore, the number of load match errors for the E5061B is the total number of combinations of stimulus ports and response ports.

Reflection tracking error (E_r)

A reflection tracking error is caused by the differences in frequency response between the test receiver and the reference receiver of a stimulus port in reflection measurements. This error can be defined as a constant value for each stimulus port because the combination of the test receiver and the reference receiver of a stimulus port is always the same. The number of reflection tracking errors for the E5061B is simply the number of stimulus ports you use.

Transmission tracking error (E_t)

A transmission tracking error is caused by the differences in frequency response between the test receiver of a response port and the reference receiver of a stimulus port in transmission measurements. When a certain port is a stimulus port, a transmission tracking error is defined for each of the ports. Therefore, the number of transmission tracking errors for the E5061B is the total number of combinations of stimulus ports and response ports.

Calibration Types and Characteristics

The table shows different types of calibrations and features of each method.

Calibration Method	Standard (s) Used	Corrected Error Factor	Measurement Parameters	Characteristics
No calibration	None	None	All parameters	<ul style="list-style-type: none"> • Low accuracy • Calibration not required
Response Calibration	<ul style="list-style-type: none"> • OPEN or SHORT • LOAD (Optional) 	Following 2 error terms: <ul style="list-style-type: none"> • Reflection Tracking (Er) • Directivity (Ed) 	S11 (Reflection characteristics at 1 port) T/R (reflection setting)	<ul style="list-style-type: none"> • Medium-level accuracy • Quick calibration • Isolation calibration improves the accuracy in a reflection measurement of a DUT with high return loss
	<ul style="list-style-type: none"> • THRU • LOAD (Optional) 	Following 2 error terms: <ul style="list-style-type: none"> • Transmission Tracking (Et) • Isolation (Ex) 	S21 (1 direction transmission characteristics at 2 ports) T/R (Transmission setting)	<ul style="list-style-type: none"> • Medium-level accuracy • Quick calibration • Isolation calibration improves the accuracy in a transmission measurement of a device with high insertion loss
1-Port Calibration	ECal module (2-port/4-port)	Following 3 error terms: <ul style="list-style-type: none"> • Directivity (Ed) • Source Match (Es) • Reflection Tracking (Er) 	S11 (Reflection characteristics at 1 port) T/R	<ul style="list-style-type: none"> • 1-port measurement with the highest degree of accuracy • Quick calibration with low chance of operator error
	<ul style="list-style-type: none"> • OPEN • SHORT • LOAD 			<ul style="list-style-type: none"> • Highly accurate 1-port measurement
Enhanced Response	Ecal module (2-port)	Following 5 error terms: <ul style="list-style-type: none"> • Directivity (Ed1) 	S11, S21 (1 direction transmission/Reflection characteristics at 2 ports)	<ul style="list-style-type: none"> • Highly accurate 2-port measurement (higher than response calibration)

Measurement

Calibration		<ul style="list-style-type: none"> • Isolation (Ex21) • Source Match (Es1) 		<ul style="list-style-type: none"> • Quick calibration with low chance of operator error
	<ul style="list-style-type: none"> • OPEN • SHORT • LOAD • THRU 	<ul style="list-style-type: none"> • Transmission Tracking (Et21) • Reflection Tracking (Er1) 		<ul style="list-style-type: none"> • Highly accurate 2-port measurement (higher than response calibration)
Full 2-Port Calibration	ECal module (2-port/4-port)	Following 12 error terms: <ul style="list-style-type: none"> • Directivity (Ed1,Ed2) • Isolation (Ex21,Ex12) • Source Match (Es1,Es2) • Load Match (El12,El21) • Transmission Tracking (Et21,Et12) • Reflection Tracking (Er1,Er2) 	S11,S21,S12,S22 (All S-parameters at 2 ports)	<ul style="list-style-type: none"> • Highly accurate 2-port measurement • Quick calibration with low chance of operator error
	<ul style="list-style-type: none"> • OPEN • SHORT • LOAD • THRU 			<ul style="list-style-type: none"> • Highly accurate 2-port measurement

Checking Calibration Status

- [Execution Status of Error Correction for Each Channel](#)
- [Execution Status of Error Correction for Each Trace](#)
- [Acquisition Status of Calibration Coefficient for Each Channel](#)

Other topics about Calibration

Execution Status of Error Correction for Each Channel

You can check the execution status of error correction for each channel with the error correction status.

The error correction status is indicated in the channel status bar at the lower part of the window by the symbols shown in the below table.

Symbol	Execution status of error correction
Cor (displayed in blue)	Error correction: On (enabled for all traces)
Cor (displayed in gray)	Error correction: On (enabled for some traces)
Off (displayed in gray)	Error correction: Off
--- (displayed in gray)	Error correction: On (no calibration data)
C? (displayed in blue)	Error correction: On (Interpolation is being executed or the IF bandwidth, power level, power range, sweep time, sweep delay time, or sweep type is different from that when the calibration was executed.) NOTE When the attenuator value of T/R port is changed after executing calibration, this symbol is displayed.
C! (displayed in blue)	Error correction: On (Extrapolation is being executed.) NOTE When the T/R input Z value is changed after executing calibration, this symbol is displayed.

NOTE When one of the trace is set as DC monitor, COR status does not change even if the sweep time is changed.

Execution Status of Error Correction for Each Trace

You can check the status of the error correction actually executed for each trace with the trace status area.

For a trace of which error correction is executed, the applied calibration type is indicated in the trace status area by the symbols in the table below.

If none of the symbols described above is displayed, error correction is not executed for the trace.

Acquisition Status of Calibration Coefficient for Each Channel

You can check the acquisition status of the calibration coefficient for each channel with the calibration property.

The calibration property displays the acquisition status of the calibration coefficient between test ports for each channel in matrix format. The following example shows 2 port full calibration which is done on ports 1 and 2, and one of the response calibration is done on the ports for gain-phase measurement.

For impedance calibration in option 005, see Acquisition Status of Calibration Coefficient in the impedance measurement section.

Example of calibration property display

		Stimulus Port		
		1	2	G
Response Port	R	1 F	2 F	-
	2	F	F	-
	G	-	-	R

S : Enhanced Response Calibration
F : Full Port Calibration
R : Response Calibration
- : Nothing

e5061b053

Procedure to turn on/off calibration property display

Follow these steps to turn on/off the calibration property display.

1. Press **Channel Next** (or **Channel Prev**) to select the channel of which you want to turn on/off the calibration property display.
2. Press **Cal** > **Property**. Each press toggles the on/off setting.

Conditions for clearing the calibration coefficients which are already acquired

In the following cases, the calibration coefficients which are already acquired are cleared.

- Executing preset clears all the calibration coefficients.
- If S parameters are required to calculate the calibration coefficient for the specified calibration type and test ports and those required for the existing calibration coefficient overlap, executing the acquisition of the calibration coefficient (measuring necessary data and then clicking the **Done** softkey) clears the calibration coefficient of which necessary S parameters overlap. Taking the Example of calibration property display as an example, if you acquire the calibration coefficient of the response calibration for test port 1, calibration coefficients for s-parameters are cleared.

Clear Calibration

This softkey clears the user calibration data. When Calibration is done for a particular DUT, the data get stored in the E5061B. To clear this data, **Clear Calibration** can be used which removes the User calibration data from the E5061B.

Other topics about Calibration

Basic Calibrations

Selecting Calibration Kit

- [Overview](#)
- [Procedure](#)

Other topics about Basic Calibration

Overview

Before performing calibration, you need to select a calibration kit.

If you use a calibration kit other than a predefined one, you need to define it. If the connector type of the standard calibration kit you use has polarity (the distinction between male and female), you need to change the standard class definition of the calibration kit depending on the standard you actually use. For more information, see [Modifying Calibration Kit Definition](#).

NOTE

If you select a predefined calibration kit, (m) and (f) in the name (label) of the standard displayed in the softkey indicate male (m) and female (f) for the analyzer's connector, respectively.

Procedure

1. Press **Channel Next** (or **Channel Prev**) to select the channel of which you want to select the calibration kit.
2. Press **Cal** > **Cal Kit**, then select the calibration kit.

NOTE

If the name (label) of the calibration kit has been changed, the label is displayed as the softkey.

NOTE

An asterisk (*) on the upper right of the softkey corresponding to a predefined calibration kit indicates that its definition value has been changed from the factory setting by the user.

OPEN/SHORT Response Calibration (reflection test)

- [Overview](#)
- S-Parameter Measurement
- Gain-Phase Measurement

Other topics about Basic Calibration

Overview

In OPEN or SHORT response calibration, calibration data are measured by connecting an OPEN or SHORT standard, respectively, to the desired test port. For frequency response, these calibrations effectively eliminate the reflection tracking error from the test setup reflection test using that port.

1-Port error model (OPEN/SHORT response)

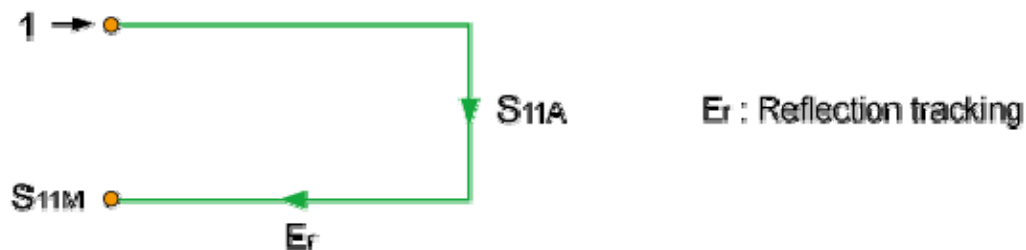

e5071c386

It is also possible to carry out isolation calibration with a LOAD standard during OPEN/SHORT response calibration. An isolation calibration eliminates the directivity error from the test setup in a reflection test using that port.

1-Port error model (OPEN/SHORT response + isolation)

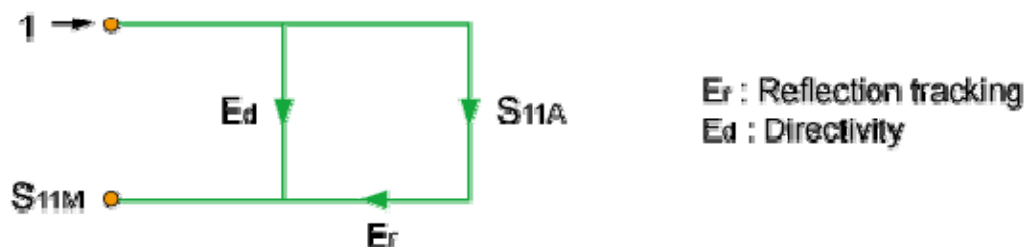

e5071c389

S-Parameter Measurement

1. Press **Channel Next** (or **Channel Prev**) to select the channel for which you want to perform the calibration. Confirm if your required setup is set to the channel.
2. Press **Cal** > **Calibrate**.

3. Select **Response (Open) or Response (Short) calibration**.
4. Click **Select Port**.
5. Select the test port upon which you will perform OPEN/SHORT response calibration.
6. Connect a calibration standard (OPEN or SHORT) to the selected test port (connector to which the DUT is to be connected).
7. Click **Open** or **Short** to start the calibration measurement.
8. If an isolation calibration must be performed using a LOAD standard, follow the procedure below.
9. Connect a LOAD standard to the selected test port (connector to which the DUT is to be connected).
10. Click **Load (Optional)** to start the measurement on the LOAD standard.
11. Click **Done** to terminate the response calibration (and the LOAD isolation calibration) process. Upon pressing this key, calibration coefficients are calculated and saved. The error correction function is also enabled automatically.

Connecting standards in OPEN/SHORT Response calibration

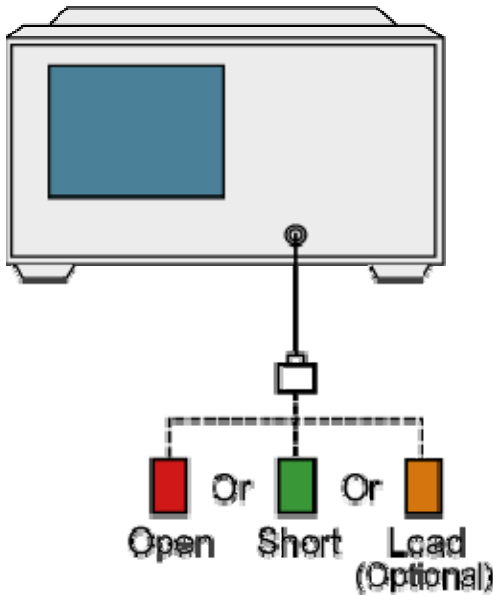

e5061b047

Gain-Phase Measurement

1. Press **Channel Next** (or **Channel Prev**) to select the channel of which you want to perform the calibration. Confirm if your required setup is set to the channel.
2. Press **Cal > Calibrate**.

3. Select **Response (Open) or Response (Short) calibration**.
4. Click **Select Port > GP Port**.
5. Connect a calibration standard (OPEN or SHORT) with the position specified in the figure below.
6. Click **Open** or **Short** to start the calibration measurement.
7. If an isolation calibration is required, follow the procedure below:
 - a. Connect a LOAD standard with the position specified in the figure below.
 - b. Click **Load (Optional)** to start the measurement on the LOAD standard.
8. Click **Done** to terminate the response calibration process. Upon pressing this key, calibration coefficients are calculated and saved. The error correction function is also enabled automatically.

Connection standards in Open/Short response calibration (Gain-Phase measurement)

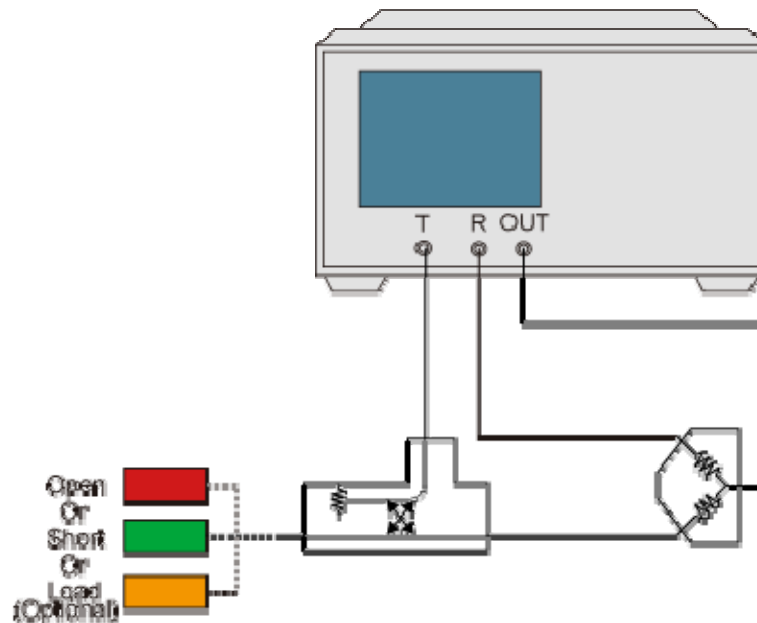

©50615048

THRU Response Calibration (transmission test)

- [Overview](#)
- S-Parameter Measurement
- Gain-Phase Measurement

Other topics about Basic Calibration

Overview

In THRU response calibration, calibration data are measured by connecting a THRU standard to the desired test port. This calibration effectively eliminates the frequency response transmission tracking error from the test setup in a transmission test using that port.

2-Port error model (THRU response)

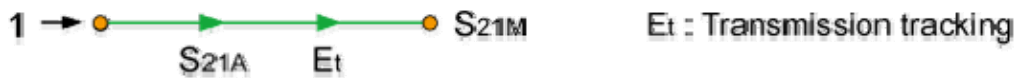

e5071c400

It is also possible to carry out an isolation calibration using a LOAD standard in the process of THRU response calibration. An isolation calibration eliminates isolation error (crosstalk error) from the test setup in a transmission test using that port.

2-Port Error model (THRU response + isolation)



e5071c401

S-Parameter Measurement

1. Press **Channel Next** (or **Channel Prev**) to select the channel for which you want to perform the calibration. Confirm if your required setup is set at the channel.
2. Press **Cal** > **Calibrate** > **Response (Thru)** > **Select Ports**.
3. Select the test ports (and corresponding S parameters) upon which a THRU response calibration is performed.

4. Make a connection between the selected test ports (between the connectors to which the DUT will be connected).

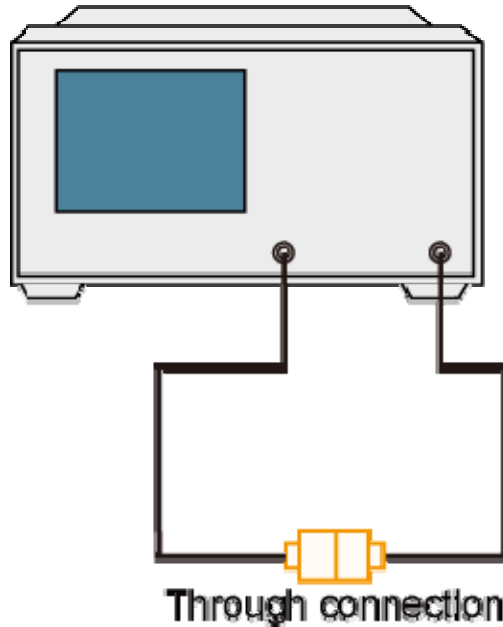

e5071c317

5. Click **Thru** to start the calibration measurement.
6. If an isolation calibration must be performed using a LOAD standard, follow the procedure below:
 - a. Connect a LOAD standard to each of the two selected test ports (connectors to which the DUT is to be connected).

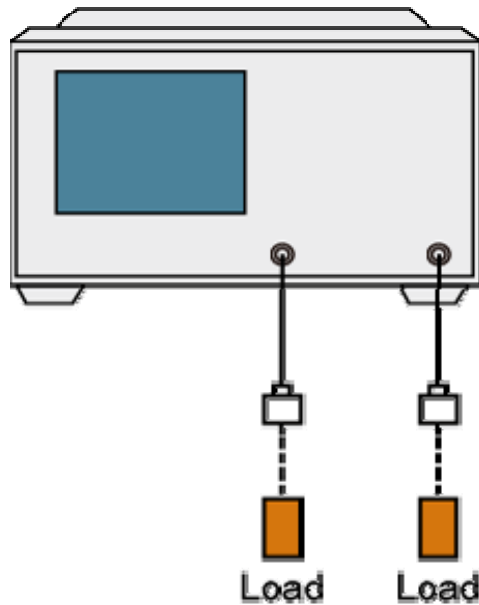

e5071e319

- b. Click **Isolation (Optional)** to start the calibration measurement.
7. Click **Done** to terminate the response calibration (and the LOAD isolation calibration) process. Upon pressing this key, calibration coefficients are calculated and saved. The error correction function is also enabled automatically.

Gain-Phase Measurement

1. Press **Channel Next** (or **Channel Prev**) to select the channel for which you want to perform the calibration. Confirm if your required setup is set at the channel.
2. Press **Cal** > **Calibrate** > **Response (Thru)** > **Select Ports** > **GP Ports**.

- Connect the cable according to following figure.

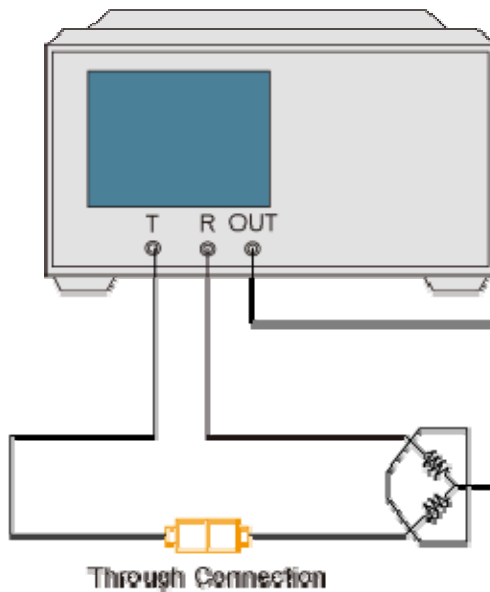

e0081b001

- Click **Thru** to start the calibration measurement.
- If an isolation calibration is required, follow the procedure below:
 - Connect the LOAD standards in the position specified in the figure below.

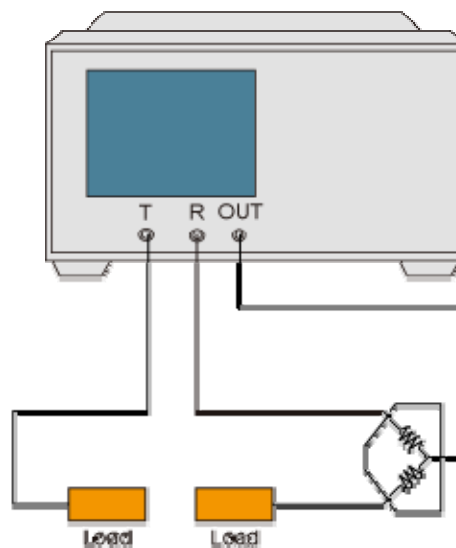

e0081b002

- Click **Isolation (Optional)** to start the calibration measurement.
- Click **Done** to terminate the response calibration (and the LOAD isolation calibration) process. Upon pressing this key, calibration

E5061B

coefficients are calculated and saved. The error correction function are also enabled automatically.

Enhanced Response Calibration

- [Overview](#)
- [Procedure](#)

Other topics about Basic Calibration

Overview

In enhanced response calibration, calibration data are measured by connecting an OPEN standard, a SHORT standard, or a LOAD standard to the output port (or a THRU standard between two ports). This calibration effectively eliminates the directivity error, crosstalk, source match error, frequency response reflection tracking error, and frequency response transmission tracking error from the test setup in a transmission or reflection test that uses those ports .

2-Port Error Model (Enhanced Response)

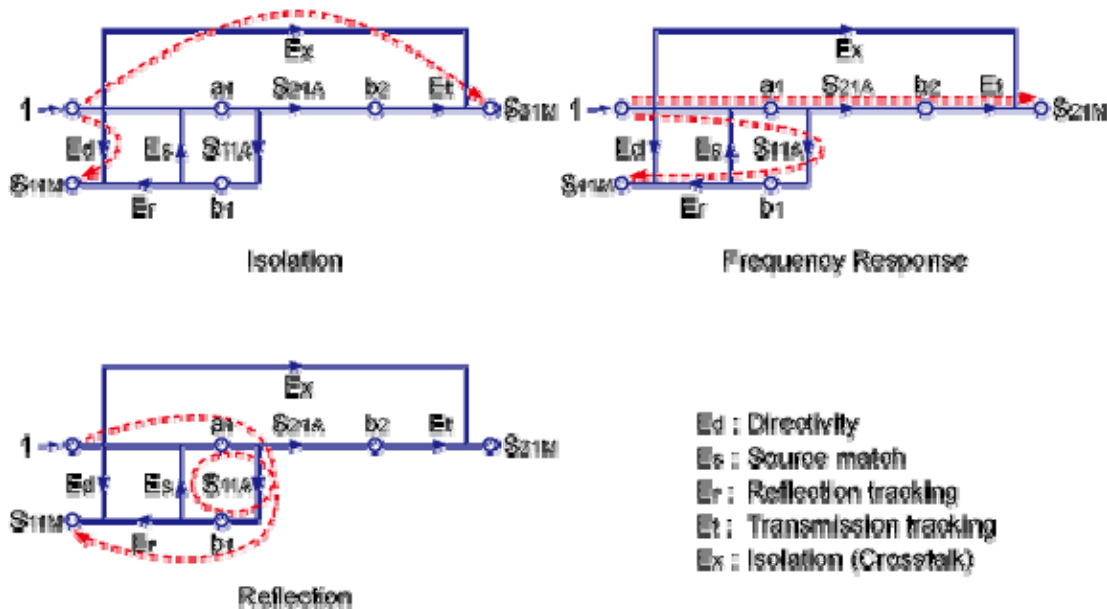

e5071e301

Procedure

Connecting the Standard at Enhanced Response Calibration

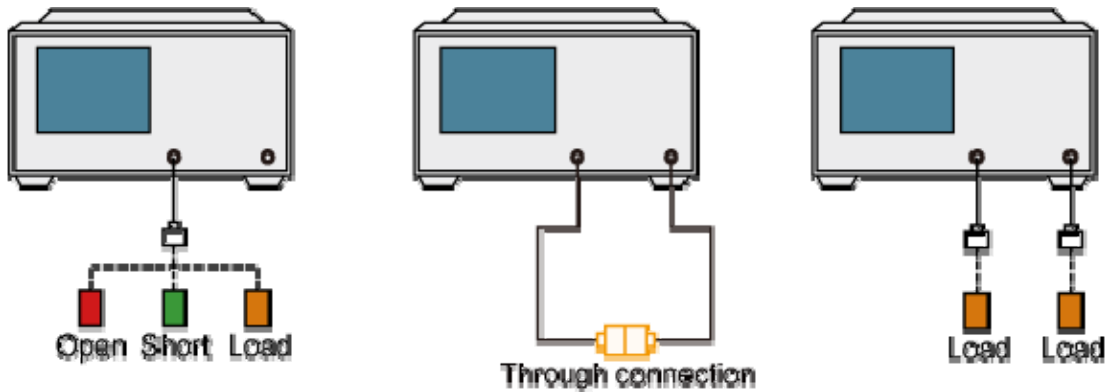

e5071c332

1. Press **Channel Next** (or **Channel Prev**) to select the channel of which you want to perform the calibration. Confirm if your required setup is set to the channel.
2. Press **Cal** > **Calibrate** > **Enhanced Response** > **Ports** to select the test ports on which an enhanced response calibration is performed.
3. Connect an OPEN calibration standard to the output port.
4. Click **Open** to start the calibration measurement.
5. Disconnect the OPEN calibration standard and replace it with a SHORT calibration standard.
6. Click **Short** to start the calibration measurement.
7. Disconnect the SHORT calibration standard and replace it with a LOAD standard.
8. Click **Load** to start the calibration measurement.
9. Make a THRU connection between the two ports.
10. Click **Thru** to start the calibration measurement.
11. If an isolation calibration must be performed using a LOAD standard, follow the procedure below:
 - a. Connect a LOAD standard to the two test ports.
 - b. Click **Isolation (Optional)** to start the calibration measurement.
12. Click **Done** to terminate the enhanced response calibration process. Upon pressing the key, calibration coefficients are calculated and saved. The error correction function is also enabled automatically.

1-Port Calibration (reflection test)

- [Overview](#)
- S Parameter Measurement
- Gain-Phase Measurement

Other topics about Basic Calibration

Overview

In 1-port calibration, calibration data are measured by connecting an OPEN standard, a SHORT standard, and a LOAD standard to the desired test port. This calibration effectively eliminates the frequency response reflection tracking error, directivity error, and source match error from the test setup in a reflection test using that port.

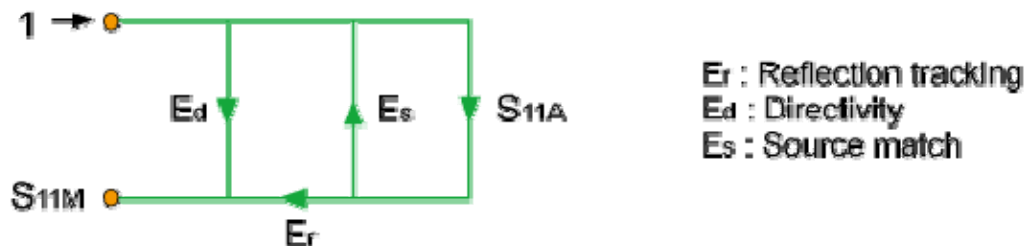

e5071c402

1-Port error model (1-port calibration)

S-Parameter Measurement

1. Press **Channel Next** (or **Channel Prev**) to select the channel of which you want to perform the calibration. Confirm if your required setup is set to the channel.
2. Press **Cal** > **Calibrate** > **1-Port Cal** > **Select Port**.
3. Select a test port (and corresponding S parameter) on which 1-port calibration will be performed.
4. Connect an OPEN calibration standard to the selected test port (connector to which the DUT is to be connected).
5. Click **Open** to start the calibration measurement.
6. Connect a SHORT calibration standard to the selected test port (connector to which the DUT is to be connected).
7. Click **Short** to start the calibration measurement.
8. Connect a LOAD calibration standard to the selected test port (connector to which the DUT is to be connected).
9. Click **Load** to start the calibration measurement.

- Click **Done** to terminate the 1-port calibration process. Upon pressing this key, calibration coefficients are calculated and saved. The error correction function is also enabled automatically.

Connecting the standard for 1-port calibration

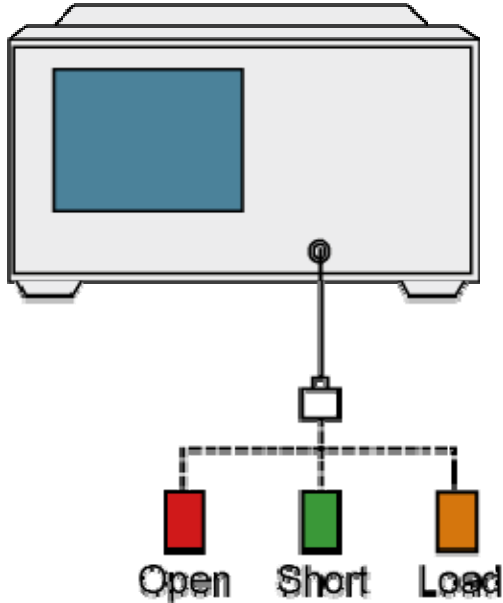

e5071c202

Gain-Phase Measurement

- Press **Channel Next** (or **Channel Prev**) to select the channel of which you want to perform the calibration. Confirm if your required setup is set to the channel.
- Press **Cal** > **Calibrate** > **1-Port Cal** > **Select Port** > **GP Port**.
- Connect an OPEN calibration standard in the position specified in the figure below.
- Click **Open** to start the calibration measurement.
- Connect a SHORT calibration standard in the position specified in the figure below.
- Click **Short** to start the calibration measurement.
- Connect a LOAD calibration standard in the position specified in the figure below.
- Click **Load** to start the calibration measurement.
- Click **Done** to terminate the 1-port calibration process. Upon pressing this key, calibration coefficients are calculated and saved. The error correction function is also enabled automatically.

Connecting the standard for 1-port calibration (Gain-Phase Measurement)

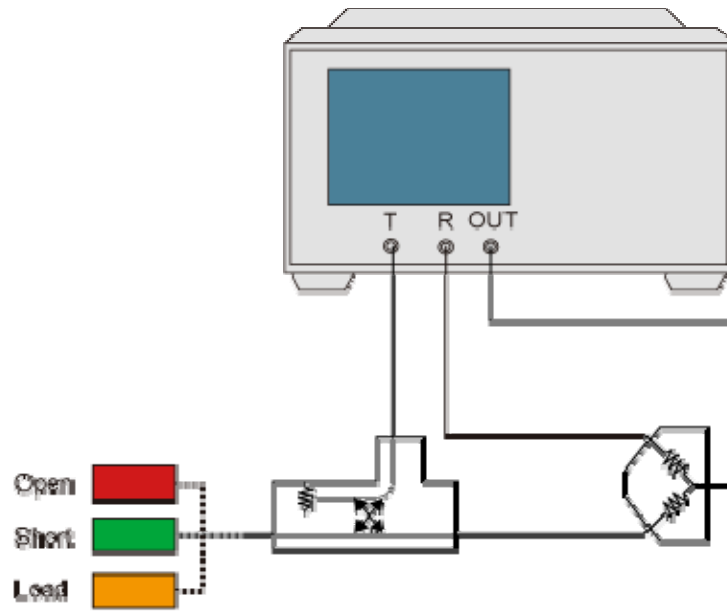

e50515448

Full 2-Port Calibration

- [Overview](#)
- [Procedure](#)

Other topics about Basic Calibration

Overview

In full 2-port calibration, calibration data are measured by connecting an OPEN standard, a SHORT standard, or a LOAD standard on ports 1 and 2 for S-parameter (or a THRU standard between two ports). This calibration effectively eliminates the directivity error, crosstalk, source match error, frequency response reflection tracking error, and frequency response transmission tracking error from the test setup in a transmission or reflection test that uses those ports. This calibration makes it possible to perform measurements with the highest possible accuracy. A total of twelve error terms, six each in the forward direction and the reverse direction, are used in the calibration.

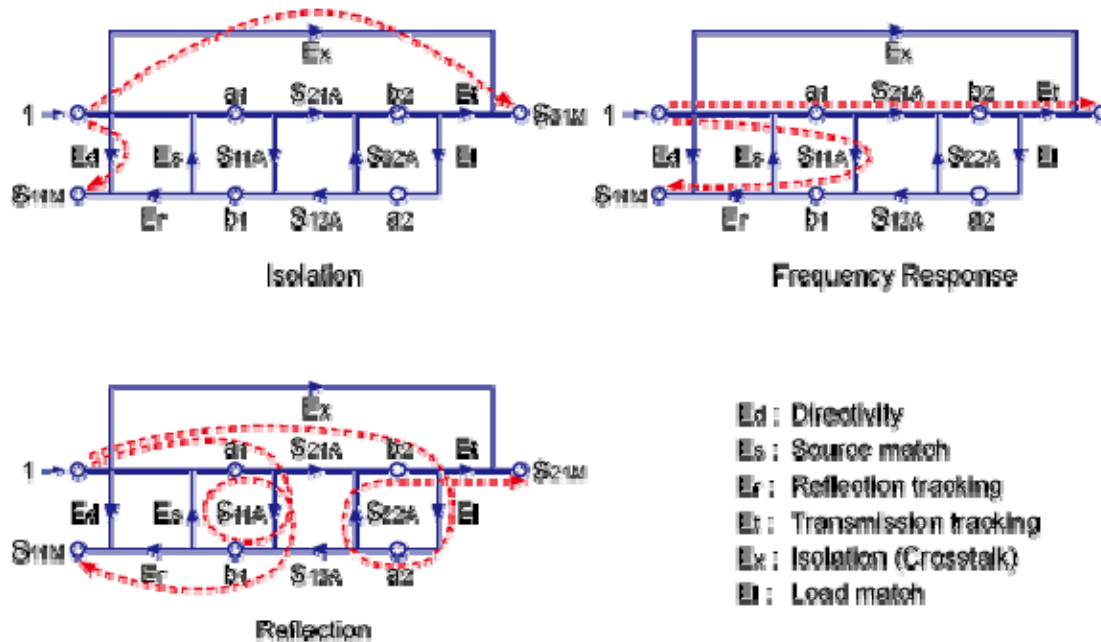

e5071c303

Procedure

1. Press **Channel Next** (or **Channel Prev**) to select the channel for which you want to perform the calibration.
2. Press **Cal** > **Calibrate** > **2-Port Cal**.
3. Click **Reflection**.

4. Connect an OPEN calibration standard to test port x (the connector to which the DUT is to be connected).
5. Click **Port x Open** to start the calibration measurement (x denotes the test port to which the standard is connected).
6. Disconnect the OPEN calibration standard and replace it with a SHORT calibration standard.
7. Click **Port x Short** to start the calibration measurement (x denotes the test port to which the standard is connected).
8. Disconnect the SHORT calibration standard and replace it with a LOAD standard.
9. Click **Port x Load** to start the calibration measurement (x denotes the test port to which the standard is connected).
10. Repeat the above procedure for port y.
11. Click **Return**.
12. Click **Transmission**.
13. Make a THRU connection between ports x and y (between the connectors to which the DUT is to be connected).
14. Click **Port 1-2 Thru** to start the calibration measurement.
15. Click **Return**.
16. If an isolation calibration must be performed using a LOAD standard, follow the procedure below.
17. Click **Isolation (Optional)**.
18. Connect a LOAD standard to each of the two test ports (connectors to which the DUT is to be connected).
19. Click **Port 1-2 Isol** to start the calibration measurement.
20. Click **Return**.
21. Click **Done** to terminate the full 2-port calibration process. Upon pressing this key, calibration coefficients are calculated and saved. The error correction function is also enabled automatically.

Connecting standards in full 2-port calibration

E5061B

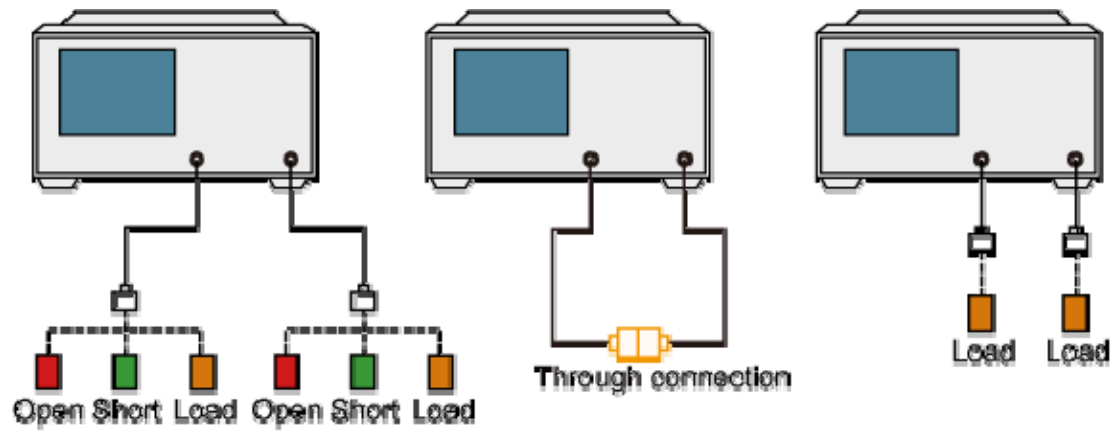

e5071c331

Calibration with ECal (Electronic Calibration)

ECal (electronic calibration)

ECal is a calibration method that uses solid-state circuit technology. ECal offers the following advantages:

- Simplified calibration process.
- Shorter time required for calibration.
- Reduced chance of erroneous operation.
- Little degradation of performance due to wear and tear because the ECal module employs PIN diodes and FET switches.

NOTE

If the frequency sweep range exceeds the frequency range of the ECal, the calibration data for the minimum frequency or maximum frequency is used for the exceeding frequency range and extrapolation is executed.

Refer the following section for ECal calibration.

- ECal Driver Installation
- Calibration Using Ecal Module
- Improving Calibration Accuracy along with ECal
- Confidence Check on Calibration Coefficients Using ECal
- Turning off ECal auto-detect function
- User-characterized ECal

Other topics about Calibration with ECal

ECal Driver Installation

When the ECal is connected to USB ports at the first time, ECal driver installation is required.

1. Connect an Ecal to the USB port of the E5061B.
2. Select **No, not this time**, then click **Next**.



3. Select **Install the software automatically (Recommended)**, then click **Next**.

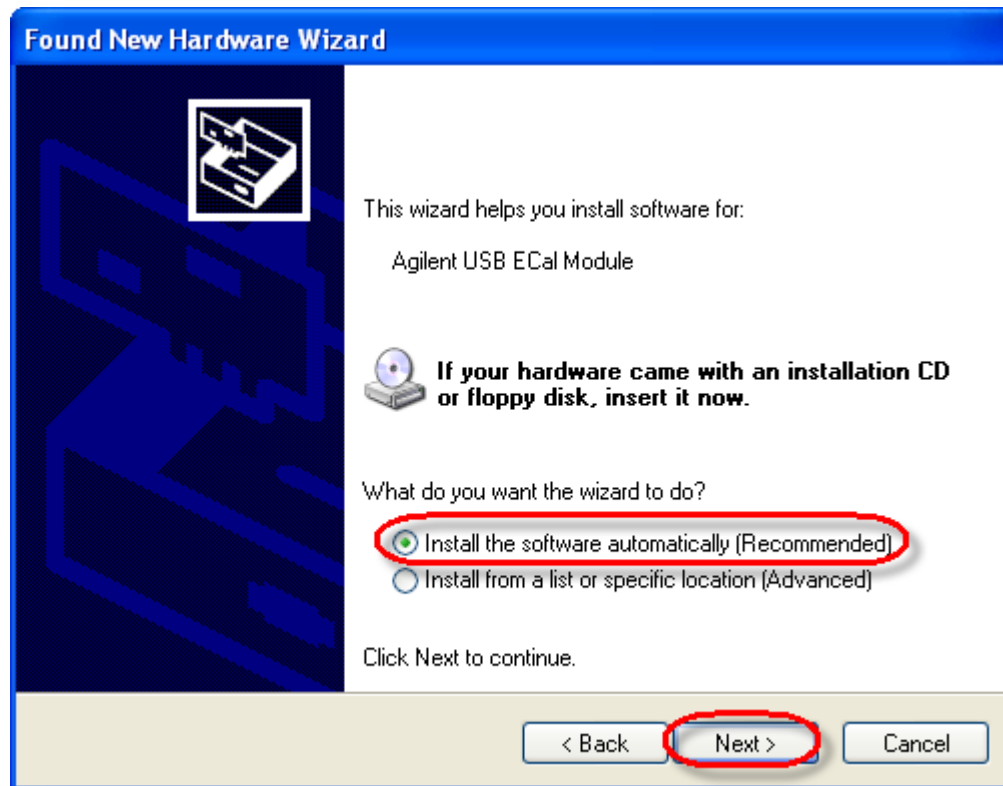

e5071c230

4. Click **Finish**.

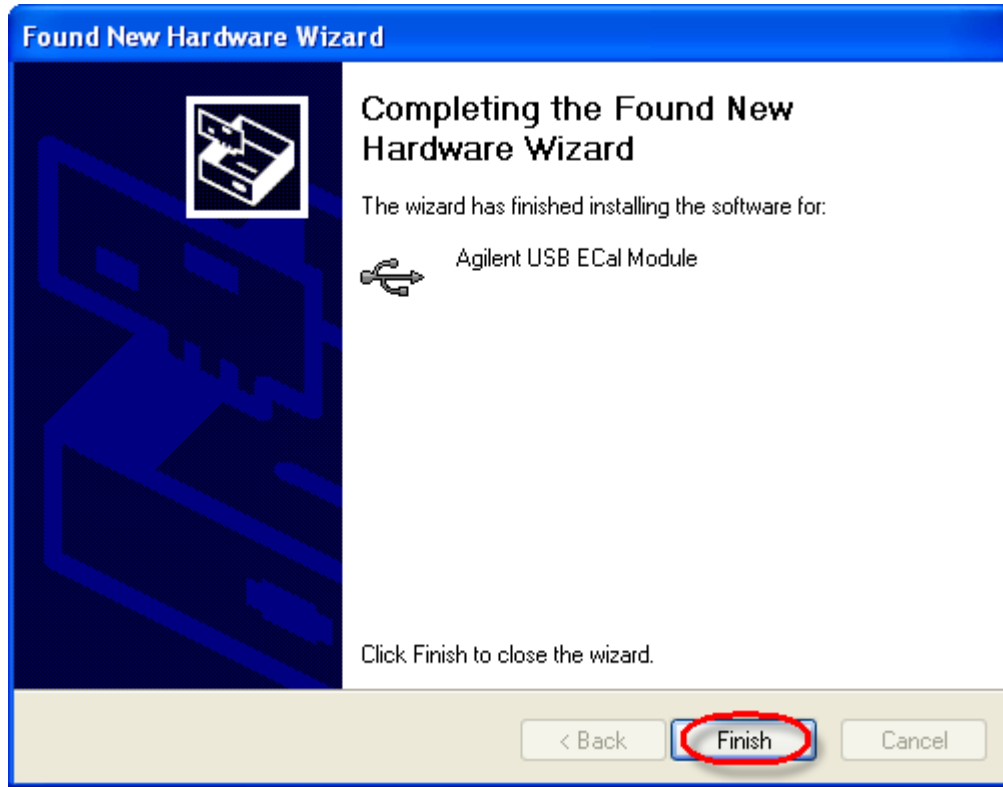

e5071c231

NOTE

Even if you install the driver on a USB port, you will be asked to install the driver again if you connect the ECal with a different USB port.

Other topics about Calibration with ECal

Calibration Using Ecal Module

- [Overview](#)
- [Procedure](#)

Other topics about Calibration with ECal

Overview

The E5061B allows you to perform calibration using the 2 or 4-port ECal module in S-parameter measurement. ECal cannot be used for Gain-Phase measurement.

Procedure

1. Connect the USB cable between the USB port of the 2 or 4-port ECal module and the USB port of the E5061B. You can make this connection while the E5061B's power is on.
2. Allow the ECal module to warm up for 20 minutes until the module indicator changes from WAIT to READY.
3. Connect the ports of the ECal module to the test ports you want to calibrate.
4. If you don't use all of the ECal module's ports, connect terminations to the unused ports.
5. Press **Channel Next** (or **Channel Prev**) to select the channel of which you want to perform the calibration.
6. Press **Cal > Ecal**.
7. Select the **calibration type**.
8. If you must select a port, the softkey for making this selection is displayed. Select a port and start calibration. If you do not have to select a port, skip this step.
9. The E5061B detects the test ports connected to the ECal and then measurement starts. If the test ports to be calibrated are not connected to the ECal module, error occurs.

Connecting 4-port ECal module (for full 2-port calibration)

E5061B

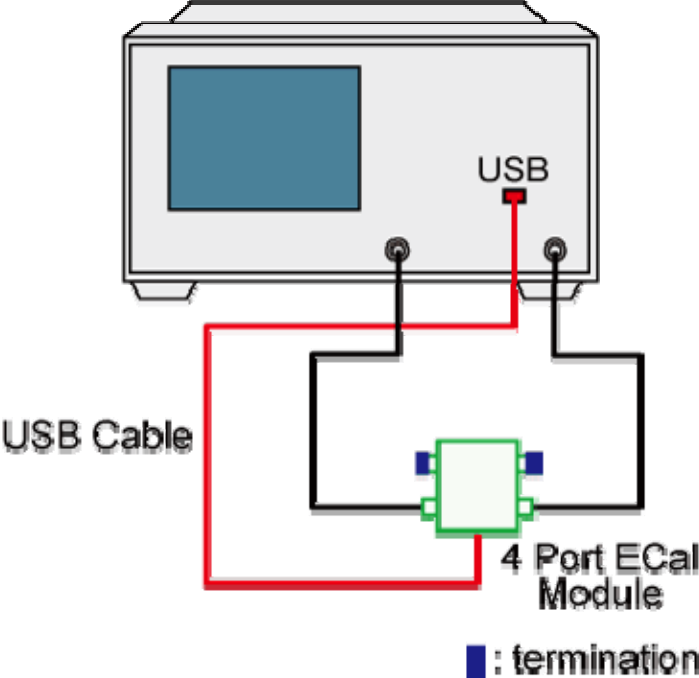

e5061b013

NOTE You can connect the ports of the ECal and the test ports of the E5061B arbitrarily. Connected ports can be manually specified although they are automatically detected before the data measurement. For more information, see Turning off ECal auto-detect function.

Improving Calibration Accuracy along with ECal

Inaccuracy caused by thru calibration in the ECal can be reduced by the using the following method:

- [Partial Overwrite](#)

Other topics about Calibration with ECal

Partial Overwrite

Using the partial overwrite function allows you to improve the calibration accuracy. For example, follow these steps for full 2-port calibration:

1. Execute full 2-port calibration with ECal and save the calibration coefficients.
2. Execute the procedure of Partial overwrite with the thru standard of the calibration kit.

Confidence Check on Calibration Coefficients Using ECal

- [Overview](#)
- [Procedure](#)

Other topics about Calibration with ECal

Overview

By using the ECal module, the E5061B allows you to verify the obtained calibration coefficients to determine whether correct measurement is possible with them.

The E5061B is able to set ECal to the state used to verify the measurement parameters and then copy the appropriate characteristics of that verification state to the memory trace from the ECal's built-in memory. This is done according to the measurement parameters of the active trace of the active channel. While measuring ECal in this specified state, you can compare the measurement results with those of the E5061B and with the appropriate measurement results stored in ECal in several different ways. These include simultaneously displaying the data and memory traces or displaying the math operation results between the data and memory traces. This enables you to verify the correctness of measurement for each measurement parameter when the obtained calibration coefficients are used.

Procedure

1. Connect the USB cable between the USB port of the ECal module and that of the E5061B. You can make this connection while the E5061B's power is ON.
2. Allows the ECal module to warm up for 15 to 20 minutes until the module indicator changes from WAIT to READY.
3. Press **Channel Next** (or **Channel Prev**) to select the channel of which you want to perform the verification.
4. Press **Meas** key.
5. Select the S-parameter you want to verify. You cannot verify the mixed mode S-parameter.
6. Connect the test ports of the E5061B corresponding to the selected S-parameter (for example, ports 1 and 2 when the S-parameter is S21) and the ports of the ECal module.
7. If you do not use all of the ECal module's ports, terminate connections to the unused ports.
8. Press **Cal** > **ECal**.

9. When using an adapter to the ECal, click **Characterization** and then press the softkey corresponding to the characterization of the adapter you are using.
10. Click **Confidence Check**.
11. Compare the data trace and memory trace and verify whether measurement is correct.
12. The following is the procedure for comparison when simultaneously displaying the data trace and the memory trace.
 - a. Press **Display** > **Display** > **Data & Mem**.
 - b. Press **Scale** > **Auto Scale**.
 - c. Determine whether the differences between the traces are acceptable. The differences should be read in terms of linear values instead of dB error. If you compare the magnitude of the linear error with the dB delta, the value is very small. So to evaluate the difference between the traces, a linear error scale should be used for comparison instead of the dB error scale.
13. For all of the parameters you want to verify, repeat the procedure.

Connecting ECal module (for verification of S21)

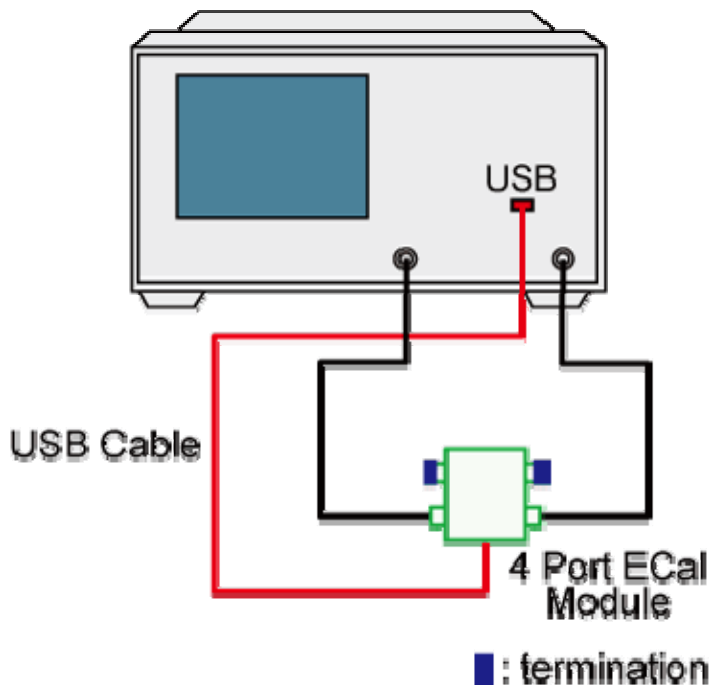

e5061b013

Turning off ECal auto-detect function

The ECal module automatically detects the connection between E5061B's test ports and ECal module's ports. You can turn off this function to set ports manually.

1. Press **Channel Next** (or **Channel Prev**) to select the channel of which you want to turn off the auto-detect function.
2. Press **Cal** > **ECal** > **Orientation** > **Manual**.
3. Specify a test port of the E5061B.
4. Specify an Ecal port for the port of the E5061B you specified.

NOTE

If the auto-detect function is turned off, no error is displayed even if the connection is wrong.

Other topics about Calibration with ECal

User-characterized ECal

- Overview
- Precautions to take in using VBA macros
- Storing user characteristics to the ECal module
- Backup/recovery of ECal module's built in flash memory
- Executing User characterized ECal

Other topics about Calibration with ECal

Overview

The E5061B allows you to execute ECal calibration with user-defined characteristics instead of the ECal characteristics defined as the factory default. This feature is called User-characterized ECal, and it is used to execute ECal calibration when an adapter is connected to the ECal module.

Before executing the User-characterized ECal, you have to measure data, such as characteristics when the adapter is connected to the ECal module, and store them to the built-in flash memory of the ECal module as the user characteristics.

Use the following VBA macro to acquire user characteristics and store them to the ECal module's built-in memory.

NOTE

The User-characterized VBA macro does not support 4-port ECal modules. Use 2 port ECal modules.

Storage folder	VBA macro name (project name)
D:\Agilent	EcalCharacterization.vba

Precautions to take in using VBA macros

- Never connect/disconnect the USB cable while executing the VBA macro.

CAUTION

In particular, the above precaution must always be observed while the VBA macro is storing data to the ECal module's built-in flash memory; disconnecting the USB cable at this time may damage the ECal module.

- Back up the flash memory contents.
The VBA macro provides a feature to back up the contents of the ECal module's built-in flash memory. Before storing user characteristics to the ECal module, be sure to use this feature to back up the flash memory's current contents.

Storing user characteristics to the ECal module

E5061B

Follow these steps to measure the characteristics while an adapter is connected to the ECal module and then to store them to the ECal module's built-in flash memory as user characteristics.

1. Connecting ECal Module

Connect the USB cable between the USB port of the ECal module and that of the E5061B. You can make this connection while the E5061B's power is ON.

2. Setting Stimulus Condition

Set the stimulus condition of the channel for which you want to measure the user characteristics. For optimal accuracy, set the IF bandwidth to 1 kHz or less.

3. Executing Calibration

For the channel of which you have set the stimulus condition, execute full 2-port calibration with a mechanical calibration kit when characterizing 2-port ECal. Define the calibration surface as the connector surface connected to each port of the ECal module in the state used to measure the characteristics.

4. Starting the VBA MACRO

- a. Press **Macro Setup** > **Load Project**.
- b. The Open dialog box appears. Specify the file name "**D:\Agilent\EcalCharacterization.vba**" and click **Open**.
- c. Press **Macro Run** key to start the macro.
- d. The ECal (1 in the figure below) displays the information of the ECal module connected to the E5061B.
- e. Click **Refresh** (2 in the figure below) to update the information if you have connected another ECal module after the macro has been started.

5. Measuring User Characteristics

- a. Select Characterize ECAL (3 in the figure below) to display the User Characteristic Measurement screen.

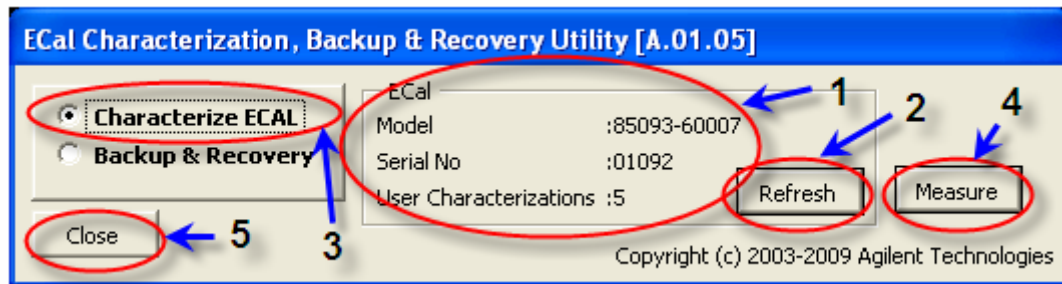

- b. After connecting the adapter to the ECal module as necessary, connect each port of the ECal module and the test port of the E5061B.

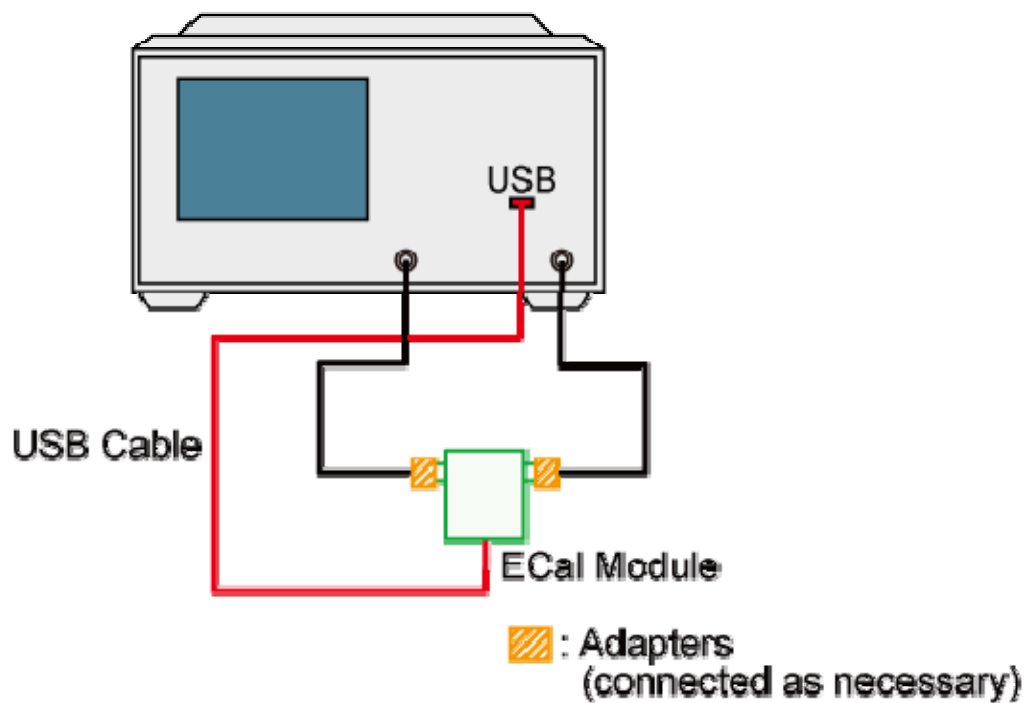

e5061b014

- c. Click **Measure** (4 in the figure) to start measurement.

NOTE

You can select any port of the ECal module and any test port of the E5061B for connection; the E5061B automatically recognizes the connected ports before measurement.

- a. When the measurement is complete, the User Characterization Info screen appears.
- b. Enter the following information.

Designation	Category	Description
1	Number	Specify a user number (a location number in the memory where you want to store the user characteristics) . If the specified location number is not used for storage, the parts Characterization, Connectors, and Adapter Description are left blank; if already used, the stored contents are displayed.
2	Characterization	Enter the information (operator, used analyzer, and so on) when measuring user characteristics as necessary.
3	Connectors	Select the connector types of the adapters for the ECal module's test ports. Male and female in the list of connected types indicate male and female adapter, respectively. Select "No adapter" if no adapter is used on a port.
4	Adapter Description	Enter the detailed information on the adapters connected to each port as necessary.

The information you have entered is displayed when checking the user characteristics information by using the key strokes: **Cal** > **Ecal** > **Characterization Info**.

- d. Click **Write**.
- e. At this time, if user characteristics are already stored for the specified user number, a dialog appears to confirm the overwrite. Click **OK**.

NOTE Although the maximum number of user characteristics stored in the ECal's memory is usually five, this number may be

limited by the memory size because the size of user-characteristics data is not fixed and increases in proportion to the number of measurement points. An error occurs when the **Write** button is pressed if the total size added to the new user characteristics exceeds this limitation due to memory size.

- f. The following dialog box is displayed to confirm execution. Click **OK** to start storing the user characteristics.

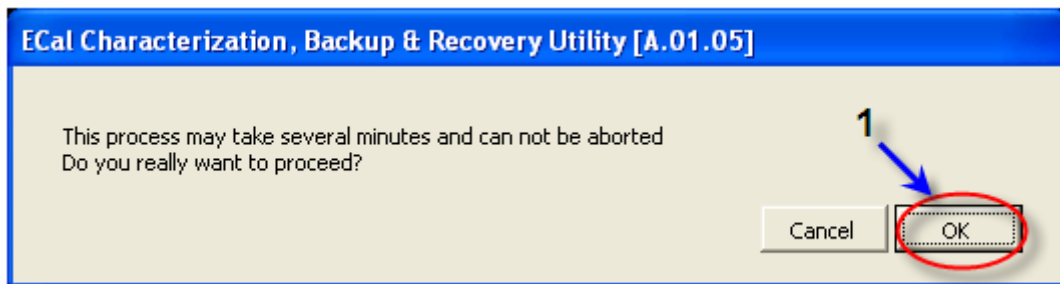

CAUTION Do not disconnect the USB cable or terminate the VBA macro by force while the VBA macro is storing data to the ECal's built-in flash memory. Doing so may damage the ECal module.

- g. The following dialog box appears while the VBA macro is storing data to memory. Storing the user characteristics takes a few minutes depending on the amount of data.

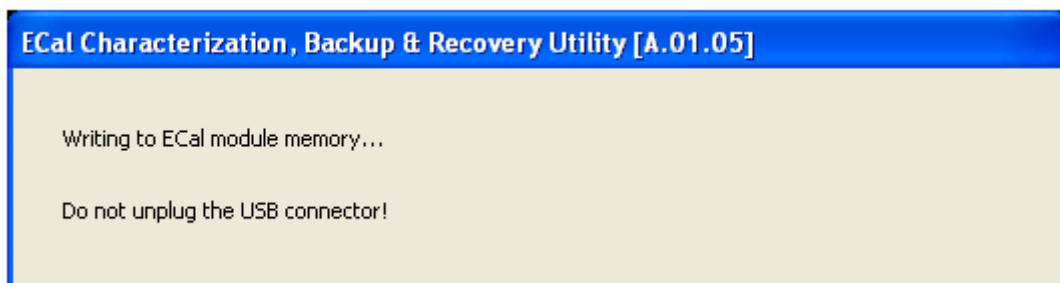

- h. Another dialog box is displayed to notify completion of data storage. Click **OK**.

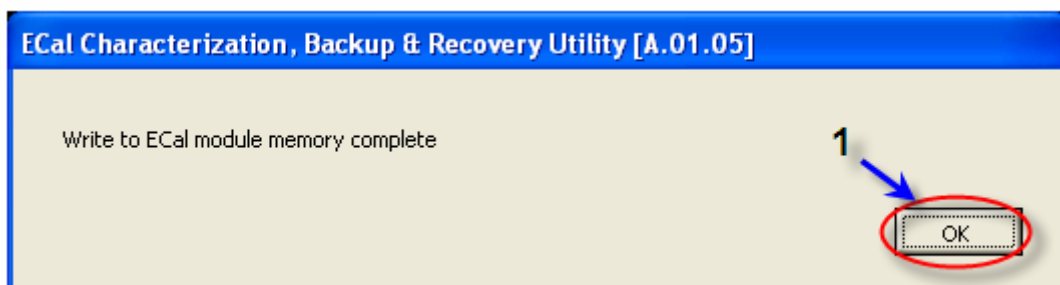

8. Closing the VBA macro

- a. Click **Close** (No. 5 in [Figure](#)) to close the macro.

Backup and recovery of ECal module's built-in flash memory

Follow these steps to back up the contents of the ECal module's built-in flash memory.

1. Connect the USB cable between the USB port of the ECal module and that of the E5061B. You can make this connection while the E5061B's power is ON.
2. Start the VBA macro according to Starting the VBA MACRO
3. Select **Backup Flash ROM** (No. 1 in the following figure) to display the Backup screen.

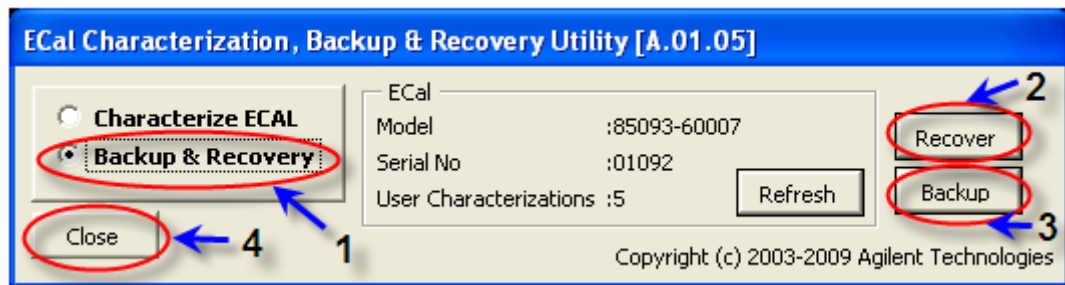

Recovery

1. Click **Recover** (No. 2 in the figure above.).
2. The Open dialog box appears. Enter the file name of the contents you want to recover and Click **Open**. If the serial number information stored in the file does not match that of the ECal module connected to the E5061B, a confirmation dialog box appears. Click **OK** to continue the recovery only if a mismatch between these serial numbers is allowed.
3. The dialog box is displayed to confirm execution. Click **OK** to start the recovery of the flash memory. The dialog box appears while the VBA macro is storing data to the memory. The recovery of the flash memory takes a few minutes depending on the amount of data.
4. The Completion screen appears. Click **OK**.

Backup

1. Click **backup**.
2. The Save As dialog box appears. Enter the name of the file you want to save and press **Save**.
3. Click **Close** to close the macro.

Executing User-characterized ECal

The execution procedure for the User-characterized ECal is the same as for normal ECal except that it requires the user characteristics to be selected in advance.

1. Press **Channel Next/Channel Prev** to select the channel of which you want to execute calibration.
2. Press **Cal > ECal > Characterization**.
3. Select a user characteristic which is specified by User Characterization Info screen.
4. To check the information on the user characteristics you have selected, click **Characterization Info**. The following dialog box appears.

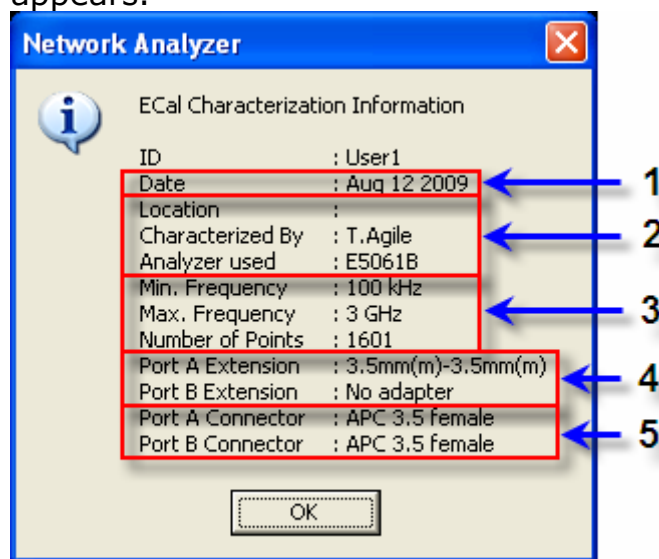

1:	The date when the user characteristics are measured
2:	The information you entered in Characterization (1 of User Characterization Info screen)
3:	The stimulus conditions when the user characteristics are measured
4:	The information you entered in Adapter Description (4 of User Characterization Info screen)
5:	The information you entered in Connectors (3 of User Characterization Info screen)

Advanced Calibrations

Modifying Calibration Kit Definition

- Definition of Terms
- [Defining Parameters for Standards](#)
- [Redefining a Calibration Kit](#)

Other topics about Advanced Calibration

In most measurements, the user can use pre-defined calibration kits as they are. However, it may be necessary to change the definition of a calibration kit (or create a new one) when changing the pre-defined connector between male and female (e.g. from **OPEN (f)** to **OPEN (m)**) or when a special standard is used or a high degree of accuracy is demanded. When it is necessary to change the definition of a calibration kit that contains a calibration device but no calibration kit model, the user must fully understand error correction and the system error model.

A user-defined calibration kit may be used in the following circumstances:

- When the user wants to use connectors other than those pre-defined in the calibration kits for the E5061B (e.g., a SMA connector).
- When the user wants to use different standards in place with one or more standards pre-defined in the E5061B. For example, when three offset SHORT standards are used instead of OPEN, SHORT, and LOAD standards.
- When the user wants to modify the standard model of a pre-defined calibration kit and turn it into a more accurate model. It is possible to perform better calibration if the performance of the actual standard is better reflected in the standard model. For example, you may need to define the 7-mm LOAD standard as 50.4 Ω instead of 50.0 Ω .

Definition of Terms

The terms used in this section are defined as follows:

Standard

An accurate physical device, for which the model is clearly defined, used to determine system errors. With the E5061B, the user may define up to 21 standards per calibration kit. Each standard is numbered from 1 to 21. For example, standard 1 for the 85033E 3.5-mm calibration kit is a SHORT standard.

Standard type

The type of standard used to classify a standard model based on its form and construction. Five standard types are available: SHORT, OPEN, LOAD, delay/THRU, and arbitrary impedance.

Standard coefficient

The numeric characteristics of the standard used in the selected model. For example, the offset delay (32 ps) of the SHORT standard in the 3.5-mm calibration kit is a standard coefficient.

Standard class

A group of standards are used in a calibration process. Class allows you to use the different standard for each port. For each class, the user must select the standards to use from the available standards.

Defining Parameters for Standards

The following figures show the parameters used in defining the standards.

Reflection Standard Model (SHORT, OPEN, or LOAD)

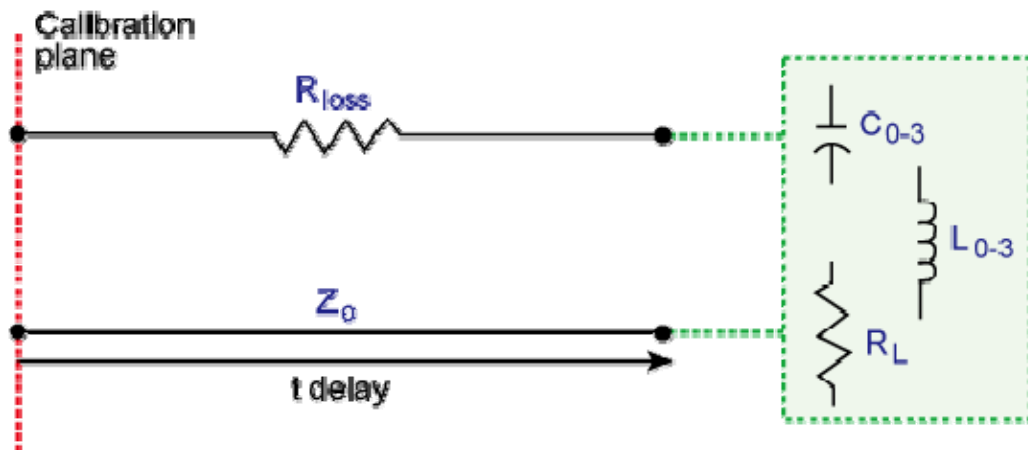

Model for Reflection Standard
(short, open, load or arbitrary
impedance)

e5061b084

Transmission Standard Model (THRU)

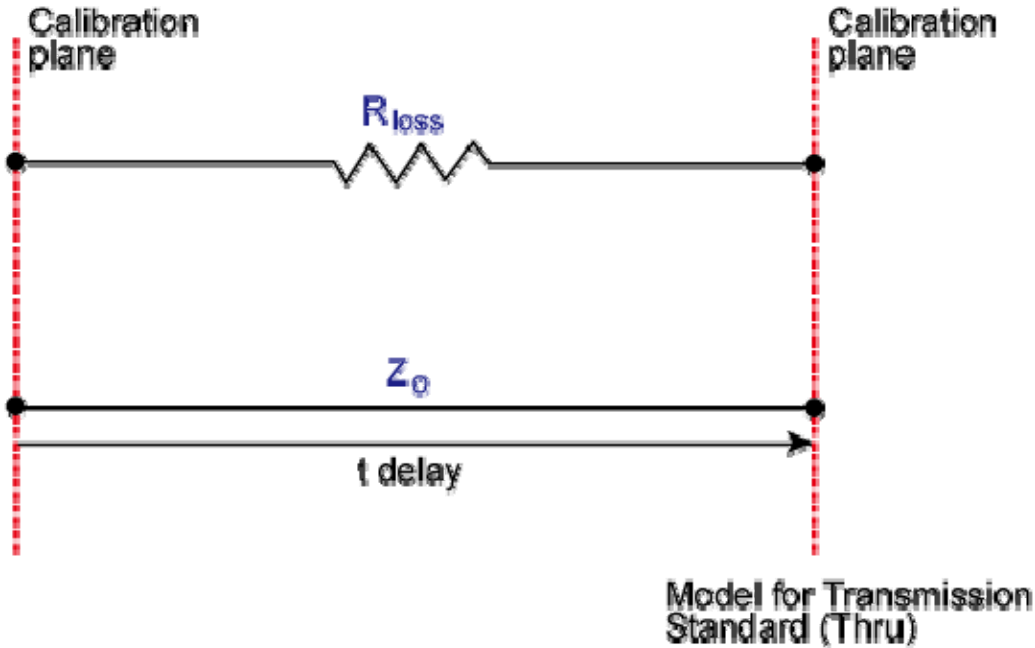

e5061b065

 Z_0

The offset impedance between the standard to be defined and the actual measurement plane. Normally, this is set to the system's characteristic impedance.

Delay

The delay that occurs depending on the length of the transmission line between the standard to be defined and the actual measurement plane. In an OPEN, SHORT, or LOAD standard, the delay is defined as one-way propagation time (sec.) from the measurement plane to the standard. In a THRU standard, it is defined as one-way propagation time (sec.) from one measurement plane to the other. The delay can be determined through measurement or by dividing the exact physical length of the standard by the velocity coefficient.

Loss

This is used to determine the energy loss caused by the skin effect along the length (one-way) of the coaxial cable. Loss is defined using the unit of ohm/s at 1 GHz. In many applications, using the value 0 for the loss should not result in significant error. The loss of a standard is determined

by measuring the delay (sec.) and the loss at 1 GHz and then substituting them in the formula below.

$$Loss\left(\frac{\Omega}{s}\right) = \frac{loss(dB) \times Z_0(\Omega)}{4.3429(dB) \times delay(s)}$$

C0, C1, C2, C3

It is extremely rare for an OPEN standard to have perfect reflection characteristics at high frequencies. This is because the fringe capacitance of the standard causes a phase shift that varies along with the frequency. For internal calculation of the analyzer, an OPEN capacitance model is used. This model is described as a function of frequency, which is a polynomial of the third degree. Coefficients in the polynomial may be defined by the user. The formula for the capacitance model is shown below:

$$C = (C0) + (C1 \times F) + (C2 \times F^2) + (C3 \times F^3)$$

F: measurement frequency

C0 unit: (Farads) (constant in the polynomial)

C1 unit: (Farads/Hz)

C2 unit: (Farads/Hz²)

C3 unit: (Farads/Hz³)

L0, L1, L2, L3

It is extremely rare for a SHORT standard to have perfect reflection characteristics at high frequencies. This is because the residual inductance of the standard causes a phase shift that varies along with the frequency. It is not possible to eliminate this effect. For internal calculation of the analyzer, a short-circuit inductance model is used. This model is described as a function of frequency, which is a polynomial of the third degree. Coefficients in the polynomial may be defined by the user. The formula for the inductance model is shown below:

$$L = (L0) + (L1 \times F) + (L2 \times F^2) + (L3 \times F^3)$$

F: Measurement frequency

L0 unit: [Henry] (the constant in the polynomial)

L1 unit: [Henry/Hz]

L2 unit: [Henry/Hz²]

L3 unit: [Henry/Hz³]

In most existing calibration kits, THRU standards are defined as "zero-length THRU," i.e., the delay and loss are both "0". Such THRU standard

does not exist, however, calibration must be done with two test ports interconnected directly.

NOTE

The measurement accuracy depends on the conformity of the calibration standard to its definition. If the calibration standard has been damaged or worn out, the accuracy will decrease.

Redefining a Calibration Kit

This section provides the procedure to change the definition of a calibration kit.

- a. Select and define a calibration kit
 1. Press **Cal** > **Cal Kit**, then select the calibration kit to be redefined.
 2. Click **Modify Kit**.
 3. If necessary, click **Label Kit** and type a new label for the calibration kit.
- b. Select the standard type and define standard coefficient
 4. Click **Define STDs** and select the standard number to be redefined.
 5. If necessary, click **Label**, then type your desired name for the selected standard.
 6. Click **STD Type**, then select the **type of standard**.
 7. Set the **standard coefficient**.
 8. Repeat steps 4 to 7 to redefine all standards for which changes are necessary, then click **Return**.
- c. Define standard class
 9. Click **Specify CLSs**, then select the **class**.
 10. Select the test port. Select **Set All** to use the same standard for all test ports.
 11. Select the standards to be registered in the class from the standard number to be redefined. Define classes for all test ports that need to be redefined, then click **Return**.
 12. Repeat the steps 9 to 12 to redefine all classes that need to be modified, then click **Return**.

Preset the definition for calibration kits

1. Press **Cal** key.
2. Click **Cal Kit**, then select a calibration kit.
3. Click **Modify Cal Kit** > **Restore Cal Kit** to preset the selected kit definition at the factory setting.

Partial Overwrite Calibration

- [Overview](#)
- [Procedure](#)

Other topics about Advanced Calibration

Overview

The partial overwrite function is used to perform partial measurement after the execution of calibration, and it overwrites the calibration coefficients.

There are three types of calibration coefficients: Er, Es, Ed for reflection, Et for transmission, and Ex for isolation. If some of them do not provide satisfactory calibration, you can use this function to re-calculate the calibration coefficients by measuring an applicable standard only instead of measuring all the standards again.

NOTE

When the calibration coefficients become inappropriate over time or the status on the E5061B side from the calibration surface changes due to replacement of a cable or connector, you also need to perform thru measurement when partial overwrite is required for reflection or isolation measurement.

NOTE

The adapter removal and partial overwrite function is only available when calibration status is [Cor] and not for [C?] or [C!].

Partial overwrite is not available if no calibration has been done. You cannot append calibration coefficients to previous calibrations. For example, you cannot realize 2-port calibration by performing additional calibration for 1 port after the execution of full 1-port calibration. The partial overwrite function is used to make measurements for previous calibration coefficients and overwrite them.

Procedure

Follow these steps to execute the partial overwrite function. The example demonstrates re-calibration thru calibration only for exiting 2 port full calibration:

1. Press **Channel Next** (or **Channel Prev**) to select the channel of which you already have performed full 2 port calibration.
2. Press **Cal** > **Calibrate** > **2-Port Cal**.
3. Click **Transmission**.
4. Make a thru connection between the ports 1 and 2.

E5061B

5. Click **Port 1-2 Thru**.
 6. Click **Return**.
 7. Click **Overwrite** to finish the re-calibration for the full 2-port calibration. At this point, the calibration coefficients are re-calculated with the new thru calibration and saved.
- .

Adapter Removal-Insertion

- [About Adapter Removal](#)
- [About Adapter Insertion](#)
- Procedure for Adapter Removal/Insertion
- Difference between Traditional Network Analyzer & E5061B Adapter Calibration

Other topics about Advanced Calibration

About Adapter Removal

Adapter Removal is a technique used to remove any adapter characteristics from the calibration plane. The E5061B uses the following adapter removal process to remove the adapter characteristics:

1. Perform calibration with the adapter in use.
2. Remove the adapter from the port and measure Open, Short, and Load values to determine the adapter's characteristics.
3. Remove the obtained adapter characteristics from the error coefficients in a de-embedding fashion.

Open, Short, and Load values measured with the adapter removed

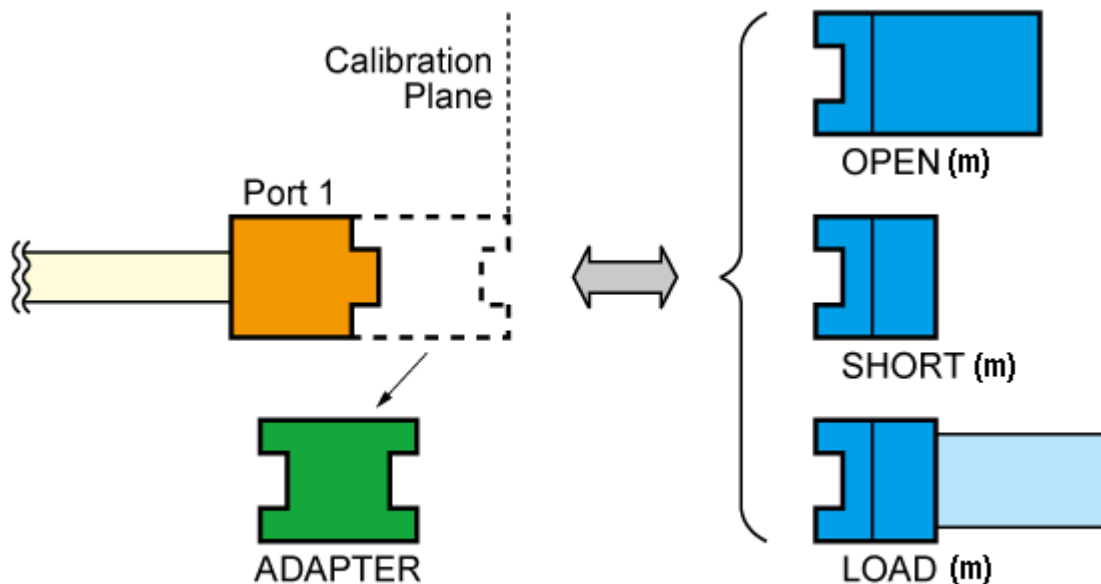

e5071c203

NOTE

The adapter removal and partial overwrite function is only available when the calibration status is [Cor] and not for [C?] or [C!].

About Adapter Insertion

The above described method also makes it possible to add adapter characteristics to a port with n-port full calibration. This allows you to make a measurement with the adapter. E5061B uses the following adapter insertion process to insert the adapter characteristics:

1. Perform calibration without adapter in use.
2. Insert the adapter to the port and measure Open, Short, and Load values to determine the adapter's characteristics.
3. Insert the obtained adapter characteristics to the error coefficients in an embedding fashion.

Open, Short, and Load values measured with adapter attached

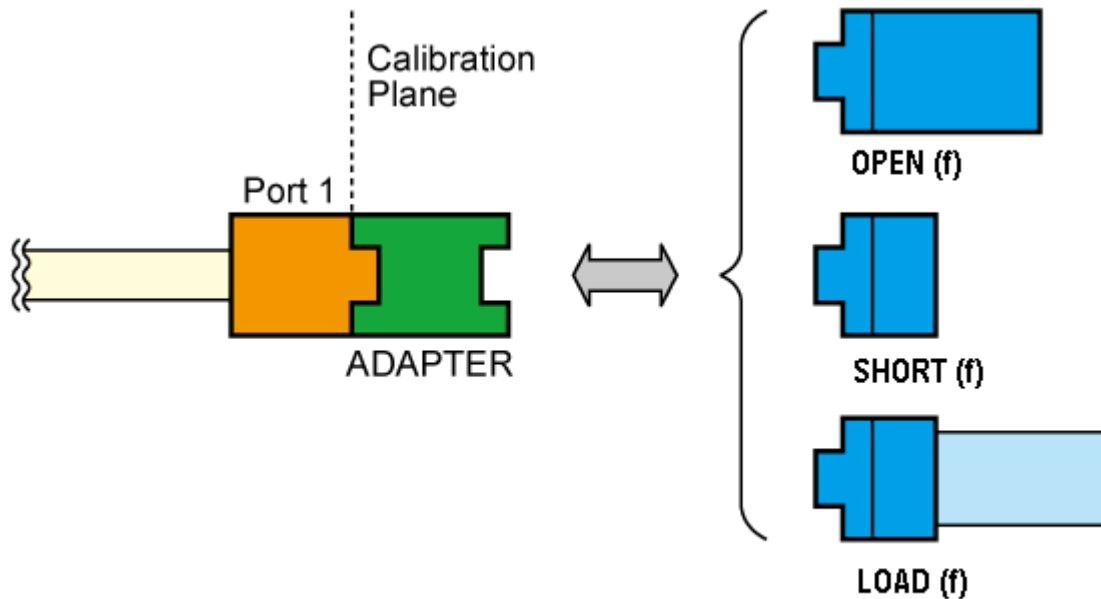

e5071c204

In order to determine the adapter characteristics (with four unknown parameters) by making three measurements (Open, Short, and Load), the adapter must satisfy the following requirements:

1. Adapter must be Reciprocal (with S_{21} and S_{12} equal) in nature. It should have a consistent behavior, and independent of the direction from which it is used.
2. The electrical length of Adapter should be known with the accuracy of $\pm 1/4$ of wavelength.

Adapter removal and insertion is not available in Gain-Phase measurement.

Procedure for Adapter Removal/Insertion

The S parameter of a reciprocal adapter can be determined when the following data is available:

- Open, Short, and Load measurements.
- Actual values derived from the **CalKit** definitions.
- An approximate length of the adapter.
- Nature of the intended operation: removal or insertion.

To use Adapter Removal/Insertion, follow the below procedure:

1. Perform a full n-Port calibration using your calibration kit so that the port used to conduct adapter insertion/removal is calibrated.

NOTE

When you need to remove an adapter from the calibration plane (adapter removal) to connect your DUT, perform the calibration with an adapter so that you can make a calibration with your calibration kit. When you need to add an adapter into the calibration plane (adapter insertion) to connect your DUT, perform the calibration without an adapter.

2. Press **Cal** > **Calibrate** > **Adapter Removal**.
3. Select a proper standard Calkit you need to use from **CalKit** (e.g. 85033E) to characterize the adapter. The calibration kit is used at the plane from which the adapter is removed (adapter removal), or the plane in which adapter is inserted (adapter insertion).
4. Select **Port 1** or **Port 2** which you want to insert/remove Adapter characteristics from/to. A * sign appears in front of the port is the valid port to conduct adapter removal/insertion as the full n-port calibration has been performed on the port.
5. Connect Open, Short, and Load of the selected **Calkit** (e.g. 85033E) with the selected port respectively and click/press **Open**, **Short**, and **Load** respectively. ENA measures the cal kit standard, calculates the adapter characteristics, and then conducts adapter removal/insertion.

NOTE

A checkmark  appears in (**Open**, **Short**, and **Load**) menu after each type of calibration is completed.

7. Click **Done** to complete the process.
8. In cases where the auto phase fails, select **Rotate Adapter** to move the adapter's phase (which is removed or inserted) to 180 degrees.
9. When you want to set the adapter length manually, press **Length** then input the value. Input 0s set at the Auto mode.

Difference between Traditional Network Analyzer & E5061B Adapter Calibration

Usually, two-port network analyzers remove the adapter characteristics by performing two sets of Full 2 Port Calibration as shown below:

Calibration performed with the adapter connected to Port2

E5061B

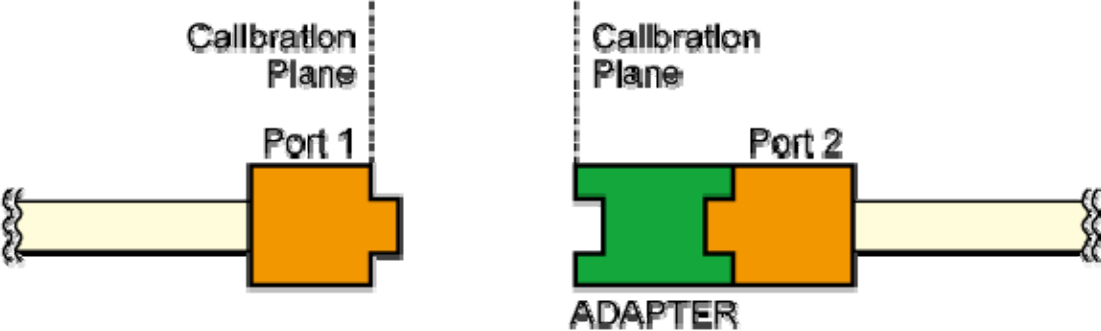

e5071c200

Calibration performed with the adapter connected to Port 1

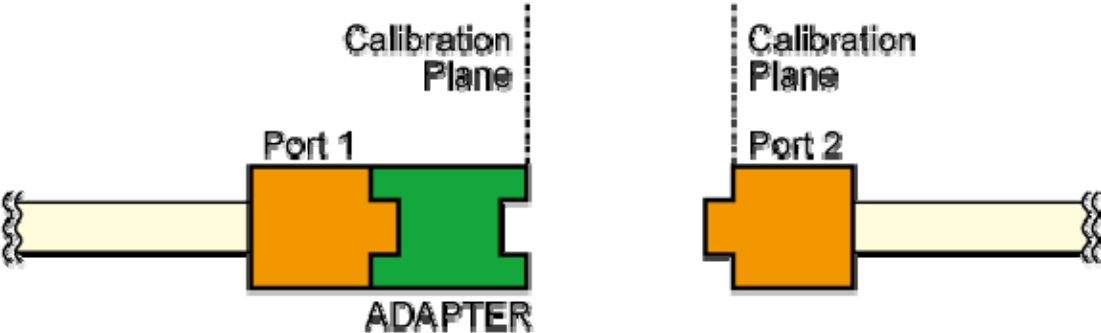

e5071c201

Removing adapter characteristics using two (above) sets of calibration

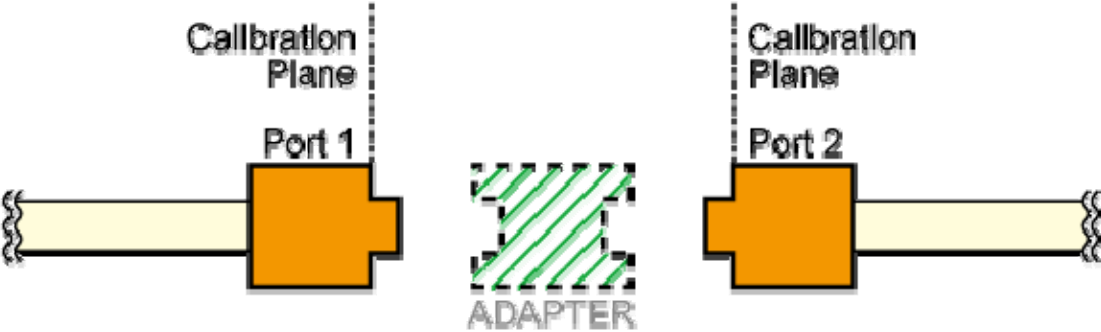

e5071c202

However, this method is not suitable for a multi-port network analyzer because it requires Full 2 Port Calibration as many as twice the number of port combinations. Therefore, the E5061B uses an advanced method to remove the Adapter characteristics described in About Adapter Insertion.

Making Measurements

Making Measurements

- Setting Up Trigger
- Making Averaging Measurement with Single Trigger
- Distributing Trigger to External Device
- Making Trigger
- Making One Time DC Measurement

Setting Up Trigger

- Overview
- Selecting Trigger Source
- Setting Trigger Mode (Single/Continuous)
- Making Trigger to Active Channel Only (Trigger Scope)
- Making One Point Measurement with Single Trigger (Point Trigger)
- Setting Trigger Delay

Other topics about Making Measurement

Overview

The E5061B has one trigger source. When this trigger source detects a trigger signal that has occurred, a sweep or point measurement is performed for channels.

The execution of measurement for each channel does not depend on whether the channel is displayed. Channels that have been activated can be measured even if they are not displayed.

For each channel, a sweep is performed only for the stimulus ports required to update the parameters of the displayed trace.

Selecting Trigger Source

The trigger source generates a cue signal that initiates a measurement process. Four types of trigger sources are available:

1. Press **Trigger** > **Trigger Source**, then select the desired **trigger source**.
2. When **External** is selected as a trigger source, click **Ext Trig Input** to select **trigger polarity**.

NOTE

The setting for trigger polarity is NOT valid for the external trigger from the 24 Bit I/O (Handler).

Setting Trigger Mode (Single/Continuous)

You can set the trigger mode for each channel independently. This allows you to control the operation of each channel after a trigger signal is detected by setting the channel's status with the trigger mode.

1. Press **Channel Next** (or **Channel Prev**) to select the channel for which the trigger mode will be set.
2. Press **Trigger**, then select the desired **trigger mode**.
3. Repeat the procedure until each channel is set to its trigger mode.

Making Trigger to Active Channel Only (Trigger Scope)

The trigger scope specifies the scope of the triggering, whether it is for all channels or for the active channel.

For example, when **Trigger > Continuous** is selected for all the channels and the trigger scope is set to active channel, a measurement channel is automatically changed by changing an active channel.

1. Press **Trigger > Trigger Scope**, then select the desired **trigger scope**.

Making One Point Measurement with Single Trigger (Point Trigger)

The point trigger provides a point measurement at every trigger, and it can be used to change the trigger event to point trigger mode.

1. Press **Trigger > Trigger Event**, then select the desired **trigger event**.

NOTE

When the trigger source is the internal trigger, the point trigger does not work.

Setting Trigger Delay

Set the external trigger delay time at each point. The trigger delay works when the trigger source is set to external.

1. Press **Trigger > Trig Delay**.
2. Enter an external trigger delay time.

See the timing chart for sweep.

Trigger Delay Time and Point Trigger Interval

External trigger pulses which are supplied until the next measurement becomes ready after the start of a one-point measurement, are ignored, and the next trigger is generated by a pulse supplied after the completion of the one-point measurement.

The time until the next trigger can be accepted after the start of a one-point measurement depends on the IFBW and other settings of the analyzer. For example, in the case of a frequency's zero-span

measurement, the time until the next measurement is ready after the start of a one-point measurement is obtained by dividing the time required for a single sweep in On Sweep mode, instead of On Point mode, by the number of measurement points. If you use the point trigger function with external trigger pulses that are wider than this time, point trigger measurement is performed at each pulse input.

The figure below shows the timing chart of an external trigger when the point trigger function is on.

Timing chart of external trigger (trigger source = external)

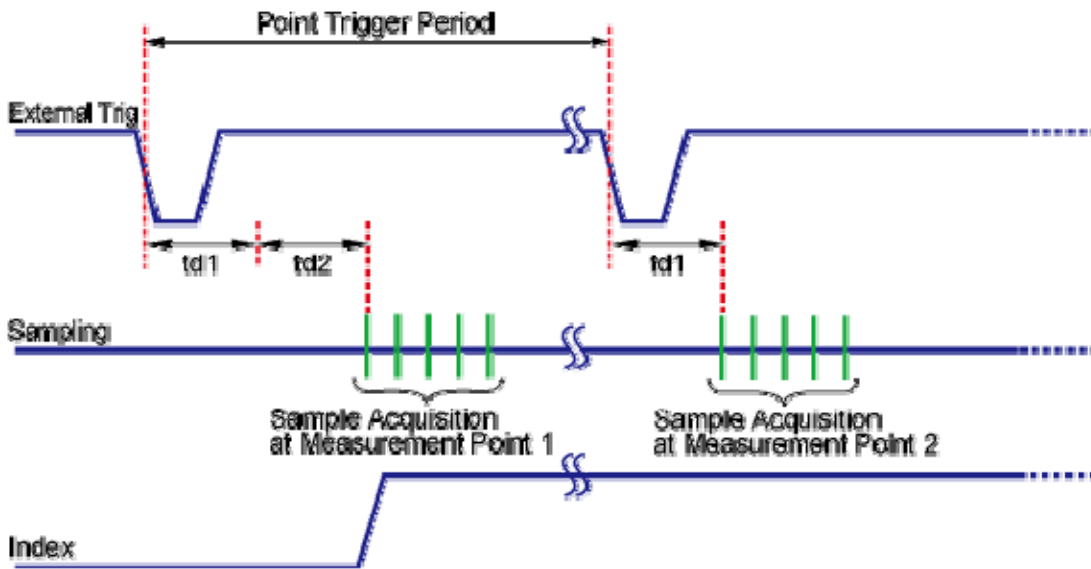

e5001b000

The table below describes signals and time as shown in the above figure.

Signal, time	Description
External Trig	External trigger signal to be supplied.
Sampling	Time while the E5061B is actually performing measurement.
Index	Index signal of the handler I/O port. When the point trigger function is ON, it goes to the High level only before starting the measurement of the first sweep point and returns to the Low level after completing the measurement of all the measurement points.

Point Trigger Period	Time until the E5061B is ready to accept a trigger for the next measurement point. The value depends on the measurement conditions and the settings of the E5061B.
td1	Time set as the external trigger delay time.
td2	Time for sweep delay

Making Averaging Measurement with Single Trigger

- [Overview](#)
- [Averaging Trigger Function](#)

Other topics about Making Measurement

Overview

The averaging trigger function is used to execute the sweep the number of times specified by the averaging factor with a single trigger when the sweep averaging function is **ON**.

Averaging Trigger	Function
ON	Performs the sweep the number of times specified by the averaging factor with a single trigger.
OFF	Performs the sweep once with a single trigger.

The averaging factor is cleared before the start of measurement.

NOTE When the point trigger function is ON, its setting has priority, and you need to generate triggers based on "(number of measurement points) × (averaging factor)".

NOTE When the sweep averaging function is OFF, sweep is performed only once even if the averaging trigger function is set to ON.

NOTE The averaging trigger function is valid for all the channels. Note that you can set the sweep averaging function for each channel.

Averaging Trigger Function

Setting Averaging Trigger Function

When the sweep averaging function is **ON**, follow these steps to set the averaging trigger function.

1. Press **Avg** > **Avg Trigger**.
2. Click **ON** to activate the averaging trigger.

Executing Averaging Measurement

1. Press **Trigger**.
2. Click **Single**. The averaging factor is cleared before the start of measurement, the sweep is executed the number of times specified by the averaging factor, and then the instrument waits for the next trigger.

Distributing Trigger to External Device

- [Overview](#)
- Setting External Trigger Output

Other topics about Making Measurement

Overview

The External Trigger Output port (located at the rear panel) can be used to provide trigger to an external device. This is useful in cases where an external device needs to be triggered through the E5061B.

Setting External Trigger Output

1. Press **Trigger** key, and then set the value of **Ext Trig Output** as **ON**.
2. Click **Polarity**, and then select **polarity**.
3. Click **Position**, and then select **position**.
4. Click **Pulse Width** to define the pulse width of the signal.

Difference between After and Before Point Settings

External trigger output function displays the difference in results by setting the Point trigger as follows:

Point Trigger On

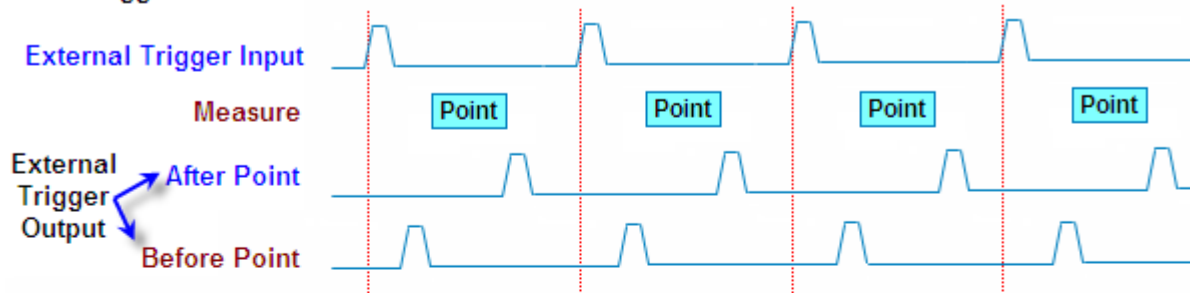

Point Trigger Off

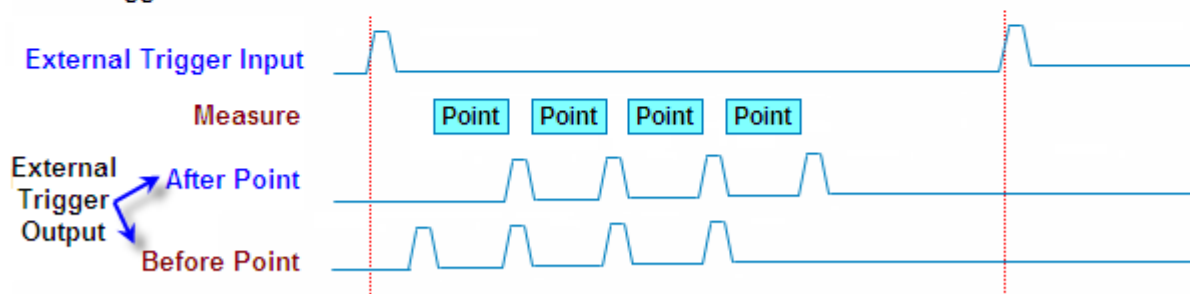

e5061b037

Making Trigger

- Generating the Trigger
- Sweep Order in Each Channel

Other topics about Making Measurement

Generating the Trigger

To make a measurement, it is necessary to generate a trigger by using the selected trigger source. Once the internal trigger is selected, a series of triggers is continuously generated as soon as the setting becomes effective.

Pressing **Trigger** > **Restart** during a sweep forces the analyzer to abort the sweep.

Sweep Order in Each Channel

In a channel, each test port is set to a stimulus port in the order of port number, and updates each trace accordingly.

Sweep Order	Stimulus Port	Updated Trace
1	Port 1	S11, S21
2	Port 2	S12, S22
3	LF Out	T/R, R, T

NOTE If full 2-port error correction is in effect, no trace between calibrated ports is updated until the last calibrated port is swept as the stimulus port.

NOTE Sweep is not executed for stimulus ports that are not required for updating traces.

Making DC Measurement at Sweep End (Option 3L5 only)

- DC Measurement at end of sweep
- Clear the DC measurement Data

Other topics about Making Measurement

DC Measurement at end of sweep

E5061B option 3L5 allows you to measure DC level at the end of measurement sweep. When this function is turned on, after the sweep is finished, the DC level is measured in the condition of the last point of sweep, then result is displayed at the upper right corner of the screen.

1. Press **Meas** > **DC Monitor Setup**.
2. Click **Function** to select **the port** for DC measurement.
3. Click **DC Monitor Sweep End** > **Monitor** to turn ON the DC monitor function.
4. The result is displayed at the upper right corner of the screen.

Clear the DC measurement Data

You can clear the DC measurement data. This can be used when you want to clear the data at the hold status.

1. Click **Meas** > **DC Monitor Setup** > **DC Monitor Sweep End** > **Clear** to reset the DC measurement at sweep end.

Analyzing Data

Analyzing Data

- Analyzing Data on the Trace Using the Marker
- Searching for Positions that Match Specified Criteria
- Determining the Bandwidth of the Trace (Bandwidth Search)
- Determining the Bandwidth of the Trace (Notch Search)
- Determining the Mean, Standard Deviation, and p-p of the Trace
- Obtaining Span, Gain, Slope, and Flatness between Markers
- Obtaining Loss, Ripple, and Attenuation of the RF Filter
- Comparing Traces/Performing Data Math
- Performing Parameter Conversion of Measurement Results
- Using Limit Test
- Using Bandwidth Test
- Using Ripple Test
- Using Equation Editor

Analyzing Data on the Trace Using the Marker

- [About Marker Functions](#)
- [Reading Marker Values on Trace](#)
- Reading Relative Value from Reference Point on Trace
- [Reading Actual Measurement Point/Value Interpolated between Measurement Points](#)
- Setting up Markers for Each Trace/Setting up Markers for Coupled Operation between Traces
- Listing Marker Values in All Displayed Channels
- Specifying Display Position of Marker Values
- Aligning Marker Value Display
- Displaying All Marker Values for Displayed Traces

Other topics about Data Analysis

About Marker Functions

The marker can be used in the following ways:

- Reading a measured value as numerical data (as an absolute value or a relative value from the reference point)
- Moving the marker to a specific point on the trace (marker search)
- Analyzing trace data to determine a specific parameter
- Using the value of the marker to change the stimulus (sweep range) and scale (value of the reference line)

For the procedure used to change the sweep range and scale by using the marker, refer to Setting the Sweep Range Using the Marker and Setting the value of a reference line using the marker.

The E5061B is capable of displaying up to 10 markers including the reference marker on each trace. Each marker has a stimulus value (the value on the X-axis in rectangular display format) and a response value (the value on the Y-axis in rectangular display format). The Smith chart and polar formats have two marker response values each (log amplitude and phase).

Reading Marker Values on Trace

You can read the value of a marker displayed on the trace.

In rectangular display format, the marker response value is always in the same data format as that of the Y-axis. On the contrary, one format of the marker response values (two values: main and auxiliary) can be selected from several types. The selection is performed in the data format.

Softkey for selecting data format	Marker response value	
	Main	Auxiliary
Smith > Lin / Phase	Linear amplitude	Phase
Smith > Log / Phase	Log amplitude	Phase
Smith > Real / Imag	Real component	Imaginary component
Smith > R + jX	Resistance	Reactance
Smith > G + jB	Conductance	Susceptance
Polar > Lin / Phase	Linear amplitude	Phase
Polar > Log / Phase	Log amplitude	Phase
Polar > Real / Imag	Real component	Imaginary component

To set up data formats, refer to [Selecting a Data Format](#).

Activating the marker on the Trace

1. Press **Channel Next** (or **Channel Prev**) and **Trace Next** (or **Trace Prev**) to activate the channel on which a marker is used.
2. Press **Marker** key. At this point, marker 1 is turned on and becomes active (you can operate the marker). When using marker 1, you can omit the next step.
3. Select a marker and turn it ON. The softkey used to turn on a marker is also used to activate that marker.

Moving the marker

1. Change the marker stimulus value. This operation enables you to move the marker to a point on the selected trace.

2. Read the marker stimulus value and marker response value displayed in the upper-left part of the trace screen.

Turning off the marker

1. Press **Marker** key.
2. Click **Clear Marker Menu** and then click one of the options.

NOTE

In the preset configuration, the marker settings on traces in a channel are coupled (Marker Couple is turned on). For marker coupling, refer to Setting up markers for each trace/Setting up markers for coupled operations between traces.

Reading Relative Value from Reference Point on Trace

You can convert the marker reading into a relative value from the reference point.

Reference Marker Mode: OFF

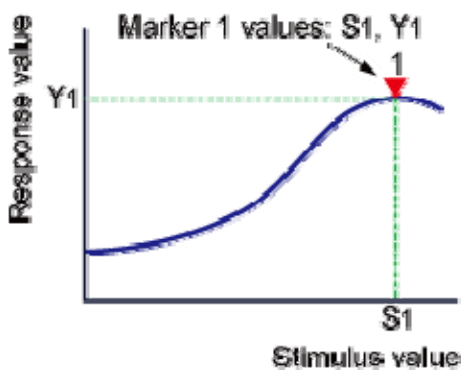

Reference Marker Mode: ON

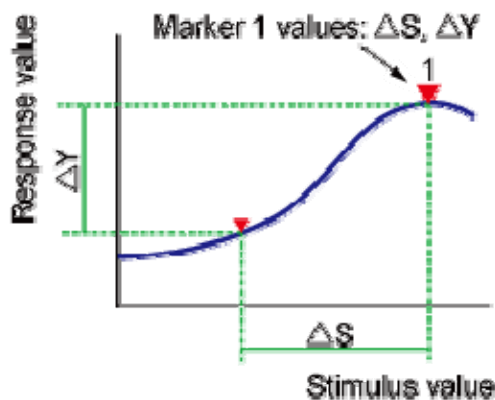

e5071c310

Converting From a Reference Point to a Relative Value

1. Activate the reference marker.
2. Move the reference marker at the point to be used as the reference.
3. Click **Ref Marker Mode** to turn on the reference mode.
4. With the reference mode turned ON, the stimulus values and response values are indicated in relative values referred to by the position of the reference marker.
5. Activate your desired marker, then move it to your desired position.

NOTE

Pressing **Marker** > **Marker** -> **Ref Marker** enables you to place the reference marker at the position of the currently active marker. The reference mode then turns ON automatically.

Reading Actual Measurement Point/Value Interpolated between Measurement Points

The point on the trace on which a marker can be placed differs depending on how the discrete marker mode is set up.

Value	Description
Turning on discrete mode (Discrete ON)	A marker moves only between actual measurement points. When a specific marker's stimulus value is specified as a numerical value, the marker is placed at the measurement point closest to the specified value. A marker placed between interpolated points with the discrete mode OFF automatically moves to the nearest measurement point when the discrete mode is turned ON.
Turning off discrete mode (Discrete OFF)	The marker can move from one actual measurement point to another. Because it is interpolated, it can also move in the space between measurement points.

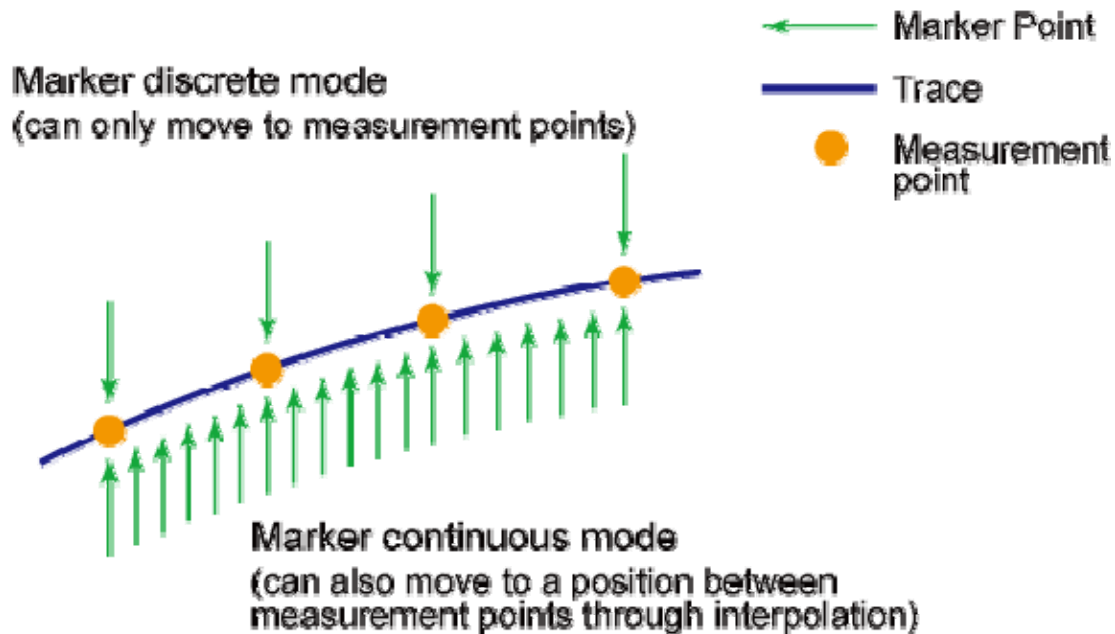

e5071c311

Turning Discrete Mode On or Off

1. Press **Channel Next** (or **Channel Prev**) and **Trace Next** (or **Trace Prev**) to activate the trace on which the discrete mode is set up.

2. Press **Marker Fctn.**
3. Click **Discrete** to turn the discrete mode ON or OFF.

Setting up Markers for Each Trace/Setting up Markers for Coupled Operation between Traces

Makers can be set up and moved either in coupled operation for all traces in a channel or independently for each trace.

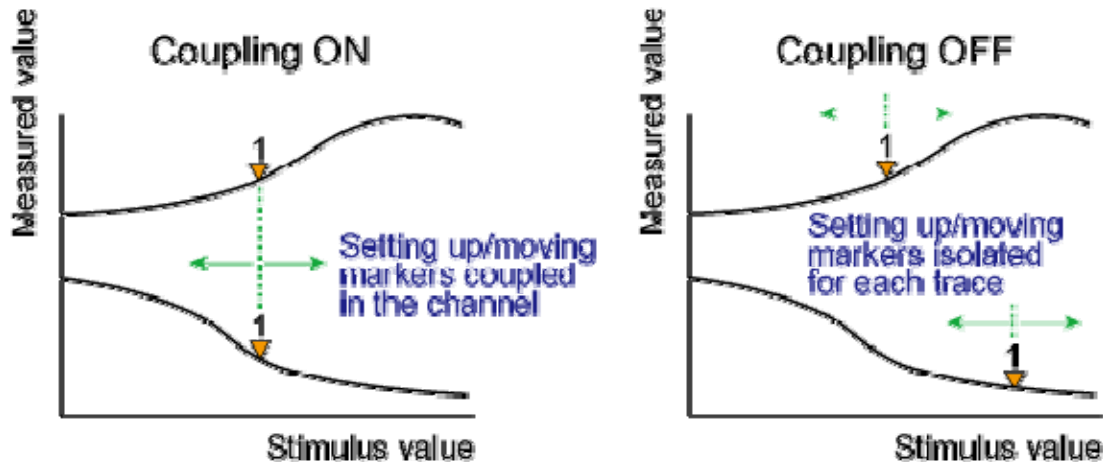

e5071e388

Value	Description
Marker Couple is ON (Coupling ON)	Markers are set up and moved in coupled operation on all the traces in a channel.
Marker Couple is OFF (Coupling OFF)	Markers are set up and moved independently for each trace.

Turning Marker Coupling On or Off

1. Press **Channel Next** (or **Channel Prev**) to activate the channel on which the marker couple is set.
2. Press **Marker Fctn.**
3. Click **Couple** to turn the marker coupling ON or OFF.

Listing all Marker Values in all Displayed Channels

You can list all of the marker values in all of the displayed channels on the screen.

Turning ON the Marker Table Display

1. Press **Marker Fctn.**
2. Click **Marker Table** to turn ON the marker table display.

The marker table appears in the lower part of the screen.



Specifying Display Position of Marker Values

This section describes how to specify the marker value display position for each active trace.

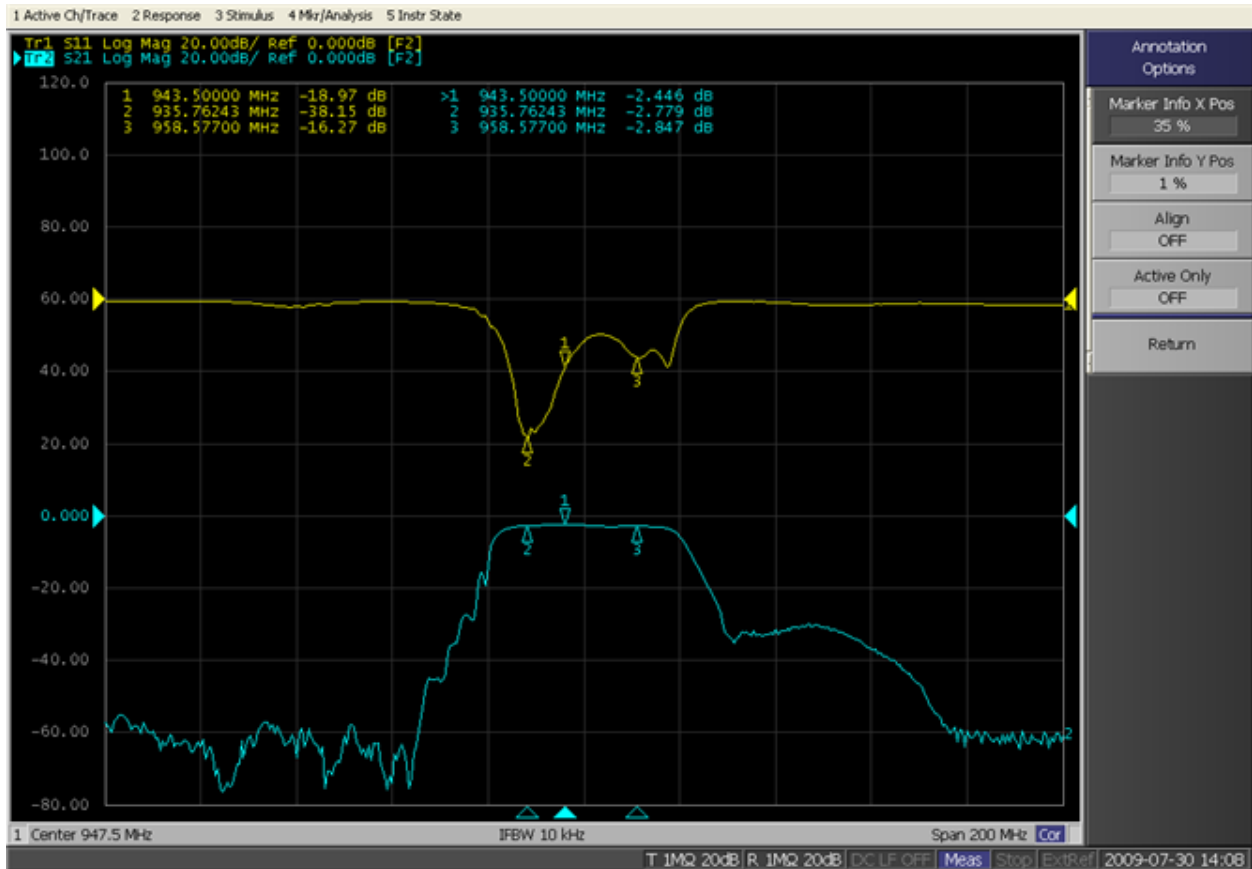

Value	Description
Marker Info X Pos	Specifies the horizontal display position by the width of the display area as a percentage.
Marker Info Y Pos	Specifies the vertical display position by the height of the display area as a percentage.

Operational procedure

1. Press **Channel Next** (or **Channel Prev**) to activate the channel for which you want to set the marker coupling.
2. Press **Marker Fctn** > **Annotation Options**.
3. Click **Marker Info X Pos** to set the horizontal display position.
4. Click **Marker Info Y Pos** to set the vertical display position.

Aligning Marker Value Display

This section describes how to align maker value displays.

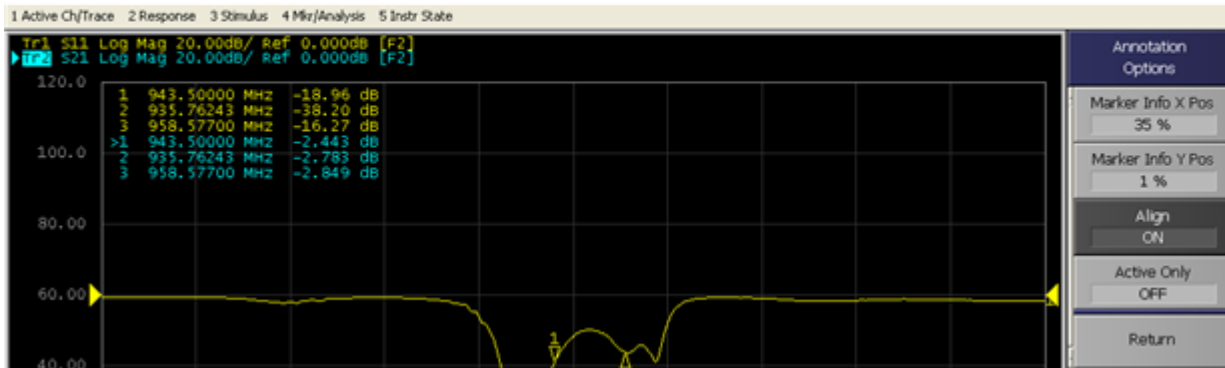
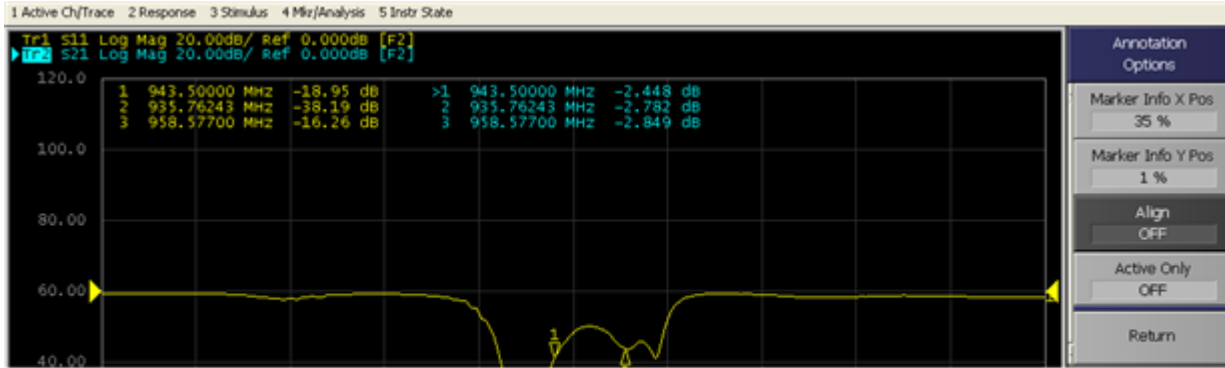

Value	Description
<i>On</i> (Align ON)	Displays marker values to align to the display position of trace 1.
<i>Off</i> (Align OFF)	Displays marker values in the display position defined for each trace.

1. Press **Marker Fctn** > **Annotation Options**.
2. Click **Align** to toggle ON/OFF.

Displaying All Marker Values for Displayed Traces

This section describes how to display all marker values for the displayed traces.

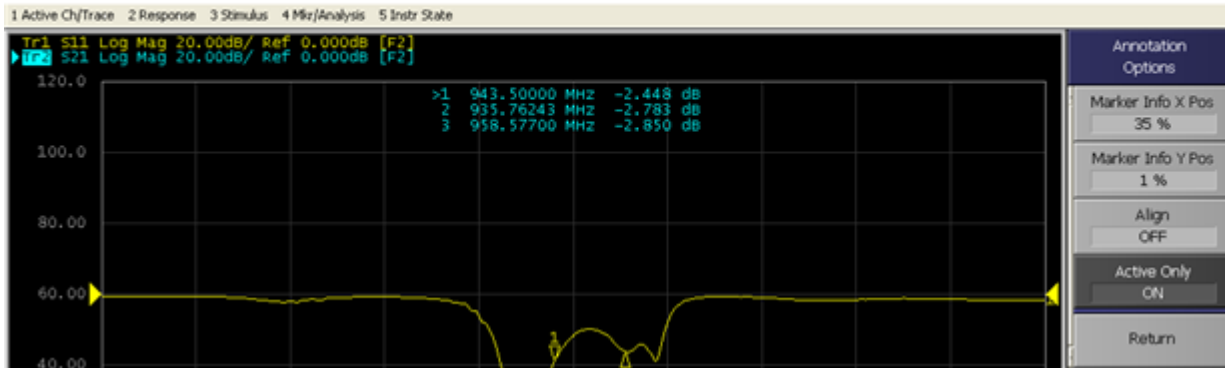
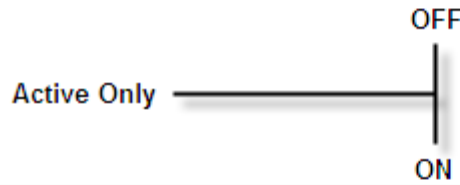
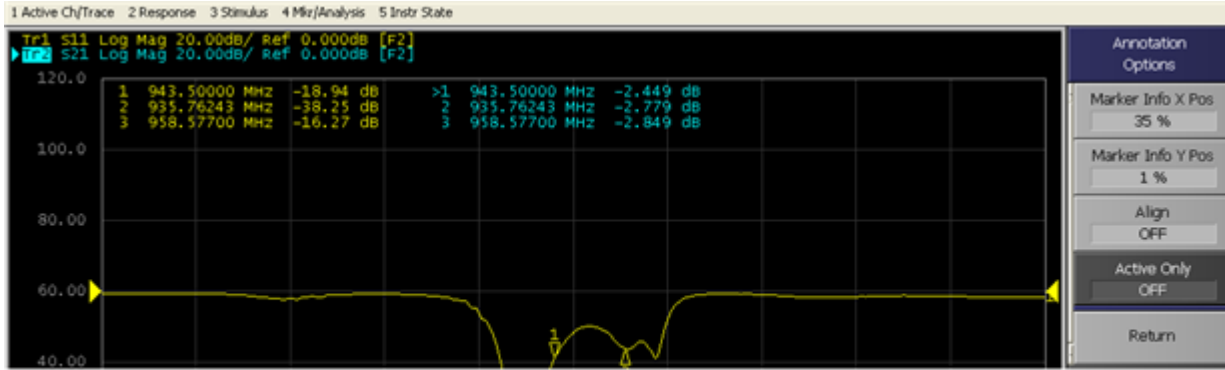

<i>Value</i>	<i>Description</i>
<i>Displays all (Active Only OFF)</i>	Displays all marker values for displayed traces.
<i>Displays active markers (Active Only ON)</i>	Displays markers for the active trace only.

1. Press **Marker Fctn** > **Annotation Options**.
2. Click **Active Only** to toggle ON/OFF.

Searching for Positions that Match Specified Criteria

- [Overview](#)
- Setting Search Range
- Automatically Executing a Search (Search Tracking)
- Searching for Maximum and Minimum Values
- Searching for the Peak
- Searching for Multiple Peaks
- Searching for the Target Value (Target search)
- Searching for the Multiple Target Values (Multi-target Search)

Other topics about Data Analysis

Overview

You can search for a position that matches your specified criteria by using the Marker Search feature. Marker Search allows you to search for a position that matches any of the following criteria.

- Maximum value
- Minimum value
- Peak
 - Maximum peak (for a positive peak), minimum peak (for a negative peak)
 - Peak on the left-hand side nearest to marker position
 - Peak on the right-hand side nearest to marker position
- Multi Peak
- Target (a point that has a target measurement value)
 - Target nearest to the marker position
 - Target on the left-hand side nearest to marker position
 - Target on the right-hand side nearest to marker position
- Multi Target

Setting Search Range

The Marker Search feature allows you to set part of the sweep range as the search target (Partial Search feature) as well as the entire search range. For the Partial Search feature, you can select whether to couple traces in the channel.

[Procedure to Turn ON/OFF Trace Coupling within Search Range](#)

1. Press **Channel Next** (or **Channel Prev**) and **Trace Next** (or **Trace Prev**) to activate the trace for which you want to set the search range.
2. Press **Marker Search** > **Search Range**.
3. Click **Couple** to toggle ON/OFF trace coupling within the search range.

Procedure to Set Search Range

1. Press **Channel Next** (or **Channel Prev**) and **Trace Next** (or **Trace Prev**) to activate the trace for which you want to set the search range.
2. Press **Marker Search** > **Search Range**.
3. Click **Search Range** to turn ON the Partial Search feature.
4. Click **Start**, then enter the start value (lower limit) of the search range.
5. Click **Stop**, then enter the stop value (upper limit) of the search range.

Automatically Executing a Search (Search Tracking)

Search tracking is a function that sets a search to be repeated every time a sweep is done even if the execution key for the search (maximum, minimum, peak, and target) is not pressed. This function facilitates observation of measurement results such as the maximum value of traces (e.g., the insertion loss of a band pass filter).

Performing Search Tracking

1. Press **Channel Next** (or **Channel Prev**) and **Trace Next** (or **Trace Prev**) to activate the trace on which you want to set up the search tracking.
2. Press **Marker Search** key.
3. Click **Tracking** and turn the search tracking function ON/OFF.

Searching for Maximum and Minimum Values

You can search for the maximum or minimum measured value on the trace and move a marker to that point.

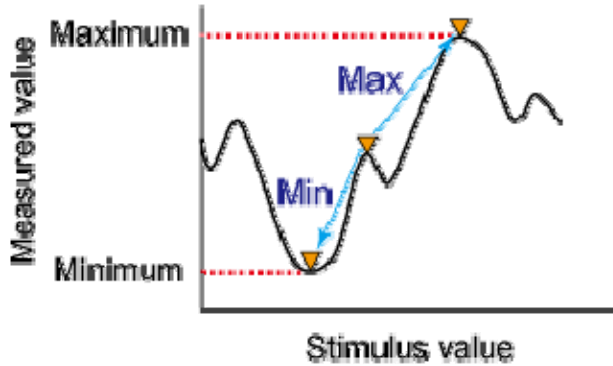

e5071c386

Search for maximum (Max)	Move active marker to point on the trace where measured value is the greatest
Search for minimum (Min)	Move active marker to point on the trace where measured value is the lowest

Procedure

1. Activate the marker you are using to search for the maximum and minimum values.
2. Press **Marker Search** key.
3. Click the corresponding softkey to move the marker to the maximum or minimum measured value.

NOTE

When the data format is in Smith chart or polar format, execute the search only for the main response value.

Searching for the peak

The peak search function enables you to move the marker to the peak on the trace.

Definition of the peak

A peak is a measurement point of which the value is greater or smaller than the adjoining measurement points on its right and left sides. Peaks are classified into the following two types depending on the differences in magnitude from the measurement points on either side of it.

Positive peak (Positive)	A peak of which the measured value is greater than the measurement points on either side of it (peak polarity: positive)
-----------------------------------	--

Negative peak (Negative)	A peak of which the measured value is smaller than the measurement points on either side of it (peak polarity: negative)
--------------------------------------	--

About Peak Excursion Value

The peak excursion value is smaller among the differences in the measured values from the adjoining peaks of the opposite polarity.

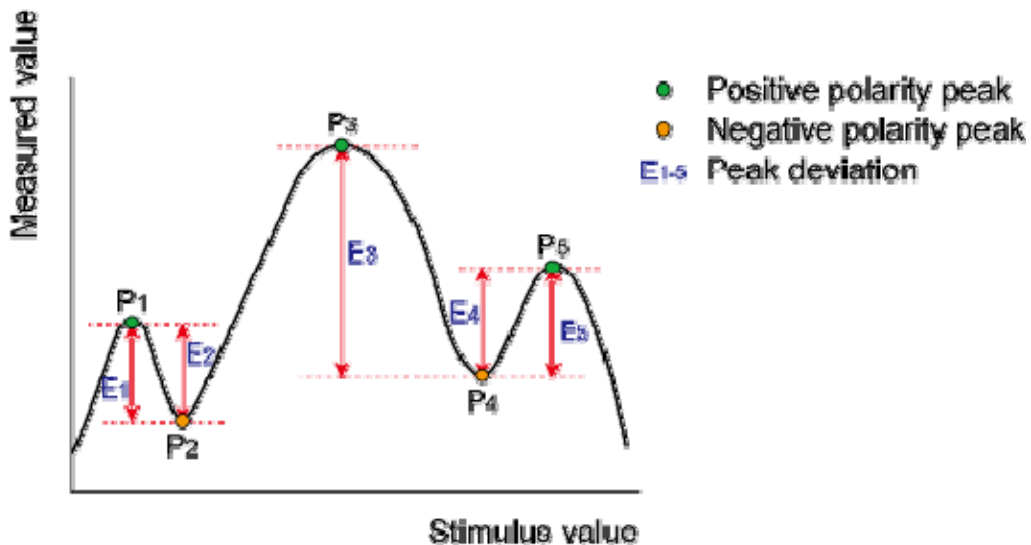

e5071c380

Executing a Peak Search

The following three methods are available for executing the peak search:

Peak search (Search Peak)	Moves the marker to the maximum peak when peak polarity is Positive or Both . Moves the marker to the minimum peak when peak polarity is Negative .
Left search (Search Left)	Executes the search from current marker position to the smaller stimulus values and moves the marker to first peak encountered.
Right search (Search Right)	Execute the search from current marker position to the larger stimulus values and moves the marker to first peak encountered.

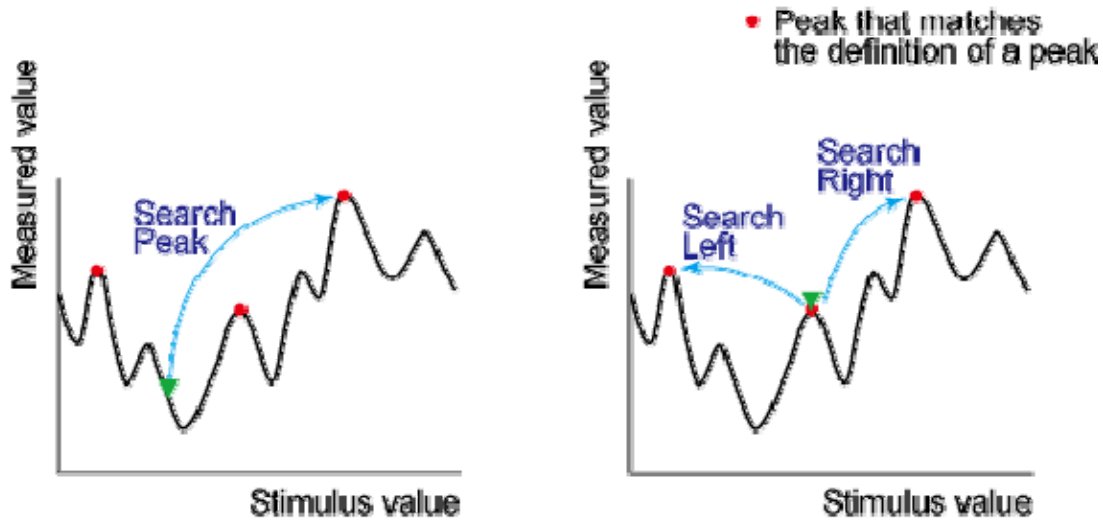

e5071e452

Procedure

1. Activate the marker you are using for the peak search.
2. Press **Marker Search** key.
3. Click **Peak > Peak Excursion**.
4. Enter the lower limit for the peak excursion value. This sets the peak search to be executed based on the definitions of the newly set lower limit for the peak excursion value and the currently set peak polarity.
5. Click **Peak Polarity**.
6. Select a peak polarity. This sets the peak search to be executed based on the definitions of the currently set lower limit for the peak excursion value and the newly set peak polarity.
7. Click the corresponding softkey to move the marker to the peak.

NOTE

When the data format is in Smith chart or polar format, execute the search for the main response value of the two marker response values.

Searching for Multiple Peaks

The multi-peak search function enables you to display markers on multiple peaks on traces.

Definition of the Peaks

A peak is a measurement point whose value is greater or smaller than the adjoining measurement points on its right and left sides. Peaks are classified into the following types depending on the difference in magnitude from the measurement points on either side of it.

Positive peak (Positive)	A peak of which the measurement value is greater than the measurement points on either side of it (peak polarity: positive)
Negative peak (Negative)	A peak of which measurement value is smaller than the measurement points on either side of it (peak polarity: negative)

[About the Multi-peak Search Function \(Search Multi Peak\)](#)

The multi-peak search is a function that searches for peaks that match with pre-defined lower limit for the peak excursion value and peak polarity (positive or negative) and then displays the markers on the peaks being searched. Depending on number of detected peaks, markers 1 through 9 are displayed from the start frequency.

The peak excursion is the smaller of the differences in measurement values from the adjoining peaks of the opposite polarity.

NOTE

When the multi-peak search is executed, search and tracking settings for markers 1 through 9 are ignored and the settings for the multi-peak search are used. Note that the reference marker is not affected.

Positive Peak/Negative Peak and Peak Excursion

Multi-peak Search (when peak polarity is positive)

[Executing a Multi-peak Search](#)

1. Activate the marker you are using for the multi-peak search.
2. Press **Marker Search > Multi Peak > Peak Excursion**
3. Enter the lower limit for the peak excursion value.

This causes the multi-peak search to be executed based on the definitions of the newly set lower limit for the peak excursion value and currently set peak polarity.

4. Press **Peak Polarity**.
5. Select a peak polarity from **positive, negative** or **both**.

This causes the multi-peak search to be executed based on the definitions of the currently set lower limit for the peak excursion value and newly set peak polarity.

6. Press **Search Multipeak** to move the marker to the peak.

NOTE

When the data format is Smith chart or polar format, execute the search for the main response value of the two marker response values.

Searching for the target value (target search)

The target search is a function that searches for a target that matches the pre-defined target value and transition type(s) (positive, negative, or both positive and negative) and then moves the marker to that target.

Target and Transition Types

A target is a point that has a specific measured value on the trace. Targets can be divided into the two groups shown below depending on their transition type.

Transition type: Positive (Positive)	When the value of the target is larger than the measured value that immediately precedes it (on the left side)
Transition type: Negative (Negative)	When the value of the target is smaller than the measured value that immediately precedes it (on the left side)

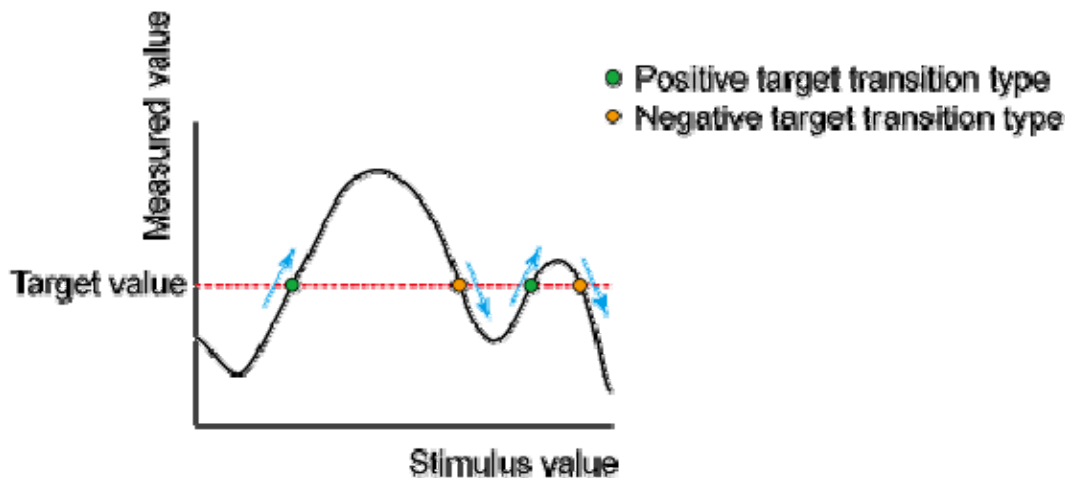

a5071c389

Executing a Target Search

The following three methods are available for executing the target search:

Target search (Search Peak)	The marker moves to the peak with maximum response value if the peak polarity is Positive or Both or to the peak with minimum response value if the peak polarity is Negative .
Search left (Search Left)	Executes the search from the current marker position to the smaller stimulus values and moves the marker

	to first encountered target.
Search right (Search Right)	Executes the search from the current marker position to the larger stimulus values and moves the marker to first encountered target.



e5071c387

Procedure

1. Activate the marker you are using for the target search.
2. Press **Marker Search** key.
3. Click **Target > Target Value**
4. Enter the target value in the entry area that appears. This causes the target search to be executed based on the definitions of the newly set target value and the currently set transition type.
5. Click **Target Transition**.
6. Select a transition type. This sets the target search to be executed based on the definitions of the currently set target value and the newly set transition type.
7. Press the corresponding softkey to move the marker to the target.

NOTE

When the data format is in Smith chart or polar format, execute the search for the main response value of the two marker response values.

Searching for the Multiple Target Values (Multi-target Search)

The multi-target search function enables you to display a marker on each point having the target measurement value.

Target and Transition Types

A target is a point that has a specific measurement value on the trace. Targets can be divided into two groups shown below depending on their transition type.

Positive	When the value of the target is larger than the measurement value that immediately proceeds it (on the left side).
Negative	When the value of the target is smaller than the measurement value that immediately proceeds it (on the left side).

Target and Transition Types

About the multi-target search function ([Search Multi Target](#))

The multi-target search is a function that searches for targets that match to pre-defined target value and transition type(s) (positive, negative, or both of positive and negative) and displays markers on the targets being searched.

Depending on the number of detected targets, markers 1 through 9 are displayed from the start frequency.

NOTE

When the multi-target search is executed, search and tracking settings for markers 1 through 9 are ignored and the settings for the multi-target search are used. Note that the reference marker is not affected.

Multi-target Search (when transition type is set to "both positive and negative")

Procedure

1. Activate the marker you are using for target search.
2. Press **Marker Search** > **Multi Target** > **Target Value**.
3. Enter a target value in the entry box that appears.

This causes the target search to be executed based on the target value newly set and the transition type defined at this point.

4. Press **Target Transition**.
5. Selects a transition type from **positive**, **negative** or **both**.

This causes the target search to be executed based on the target value set at this point and the transition type newly set.

6. Press **Search Multi Target** to move the marker to the target.

NOTE

When the data format is in Smith chart or polar format, execute the search for the main response value of the two marker response values.

Determining the Bandwidth of the Trace (Bandwidth Search)

- [Overview](#)
- Executing a Bandwidth Search

Other topics about Data Analysis

Overview

The bandwidth search is a function for determining the bandwidth of the trace, center frequency, cut-off points (on the higher frequency and the lower frequency sides), Q, and insertion loss based on the position of the active marker. The definitions of the parameters determined through the bandwidth search are shown below.

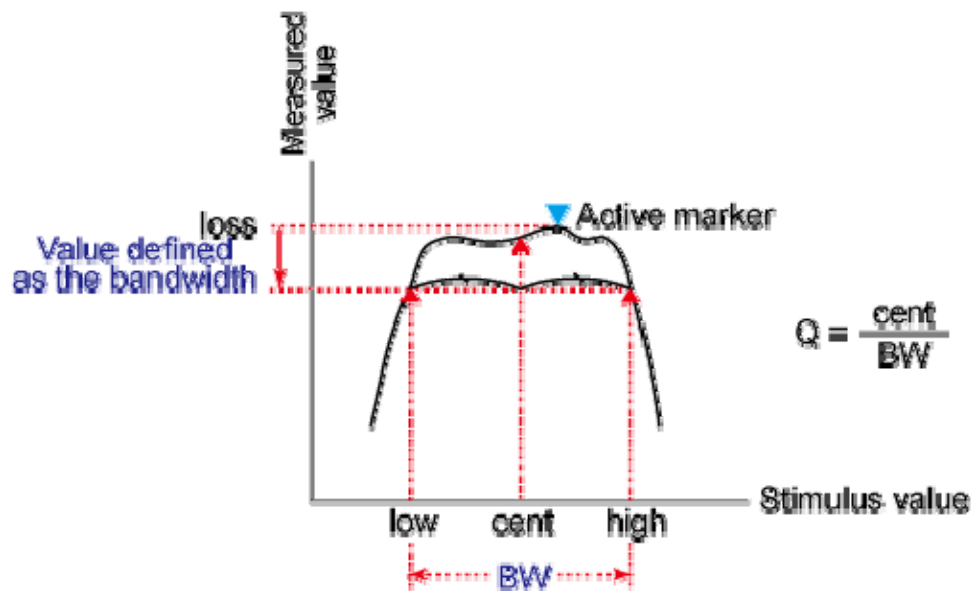

e5071c392

Bandwidth Parameter	Definition
Insertion loss (<i>loss</i>)	The measured value of the position of the active marker at the time the bandwidth search is executed.
Lower frequency cut-off point (<i>low</i>)	Lowest frequency within two measurement points, both separated by the defined bandwidth value from the active marker position.
Higher frequency cut-off point	Highest frequency within two measurement points, both separated by the defined bandwidth

<i>(high)</i>	value from the active marker position.
Center frequency <i>(cent)</i>	Frequency at the midpoint between the lower frequency cut-off and higher frequency cut-off points. $(high+low)/2$
Bandwidth (<i>BW</i>)	The difference in frequency between the higher frequency cut-off and lower frequency cut-off points. $(high-low)$
<i>Q</i>	Value obtained by dividing the center frequency by the bandwidth. $(cent/BW)$

Executing a Bandwidth Search

1. Place the active marker at the desired point on the trace on which the bandwidth search is executed. The response value of this active marker itself is the insertion loss in the bandwidth search (**loss**).
2. Press **Marker Search** > **Bandwidth Value**.
3. Enter the defined bandwidth value in the entry area that appears.
4. Click **Bandwidth** to turn ON the bandwidth search. In the upper left of the trace display, six bandwidth parameters are displayed.

Bandwidth search results

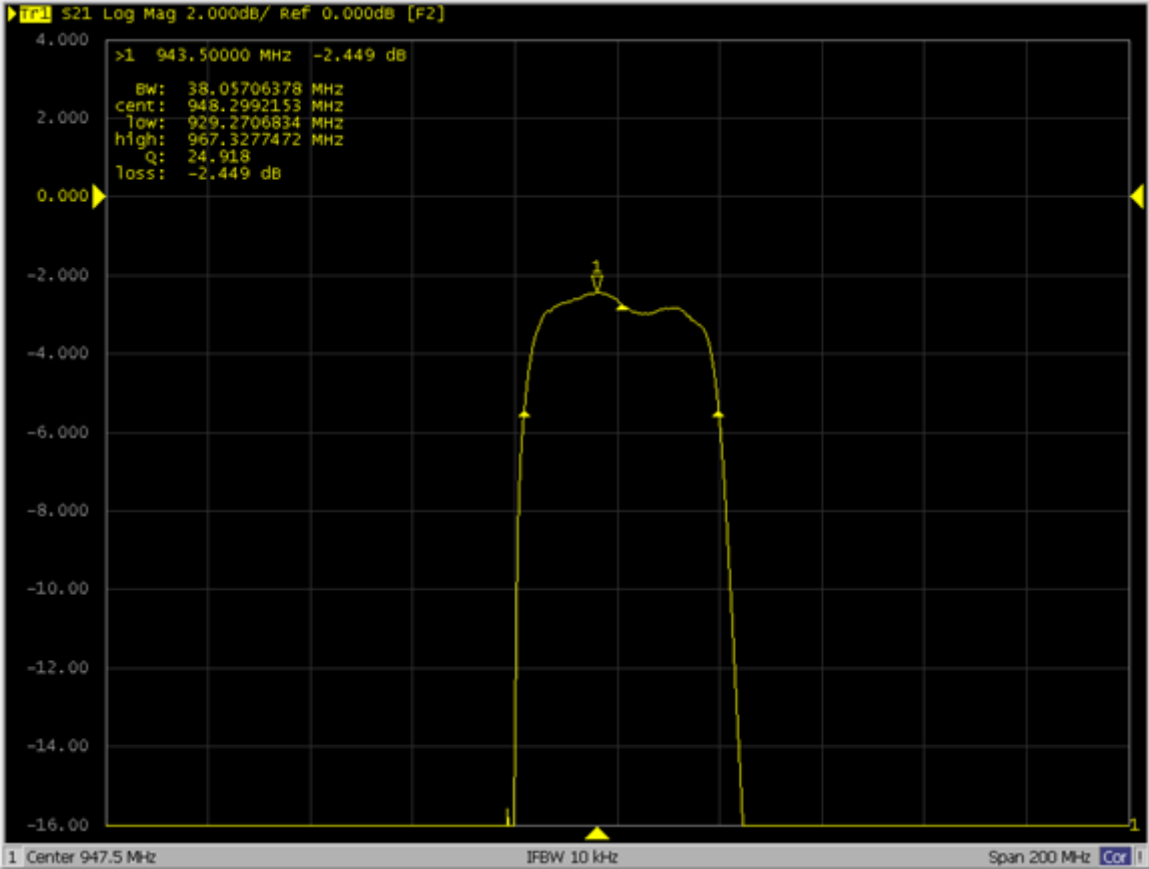

Determining the Bandwidth of the Trace (Notch Search)

- [Overview](#)
- [Executing a Notch Search](#)

Other topics about Data Analysis

Overview

The notch search function is used to obtain the bandwidth, center frequency, cutoff points (high-frequency side and low-frequency side), Q, and insertion loss of a trace based on the active marker position. The notch search function starts from the left side of the active marker position, and ends when the points meet the conditions.

The figure and table below shows the definition of parameters obtained by notch search function. The notch value in figure below must be specified by the user.

Bandwidth Parameters

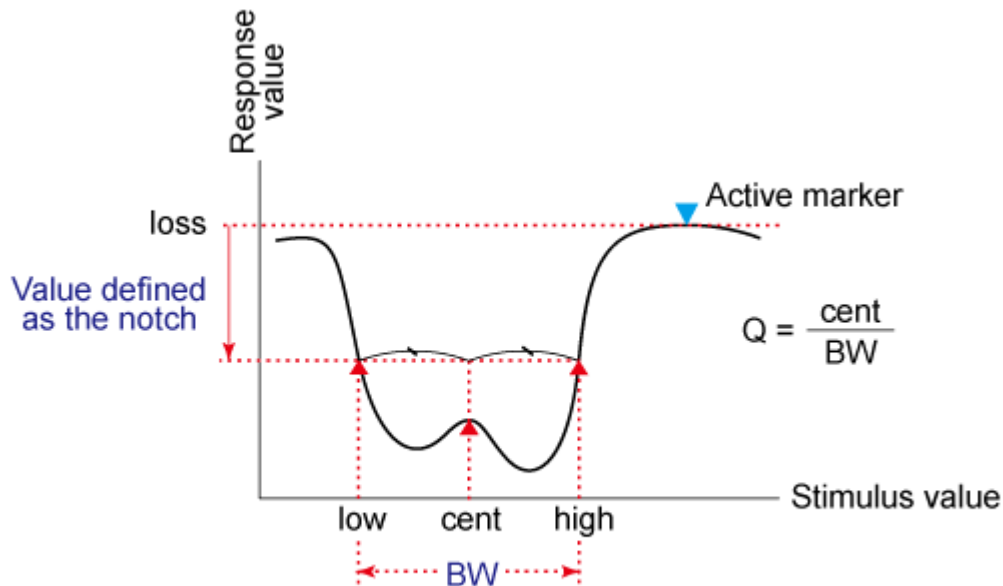

e5071c484

Definition of bandwidth parameters

Bandwidth parameter name	Definition
Insertion loss (loss)	Measurement value at the active marker position when the notch search is executed.

Lower cutoff point (low)	Lower frequency of the 2 points on both sides that have the measurement value apart from the active marker position by the notch value.
Higher cutoff point (high)	Higher frequency of the 2 points on both sides that have the measurement value apart from the active marker position by the notch value.
Center frequency (cent)	Frequency of the middle point between the lower cutoff point and the higher cutoff point (high + low)/2.
Bandwidth (BW)	Frequency difference between the higher cutoff point and the lower cutoff point (high – low).
Q	Value obtained by dividing the center frequency by the bandwidth (cent/BW).

Executing a Notch Search

1. Place the active marker on the desired point on the trace on which the notch search is executed. The response value of this active marker itself is the insertion loss in the notch search (loss).
2. Press **Marker Search** > **Notch Value** and enter the notch value in the entry area that appears.
3. Press **Notch** to turn ON the notch search. In the upper left of the trace display, six bandwidth parameters are displayed (see the figure below).

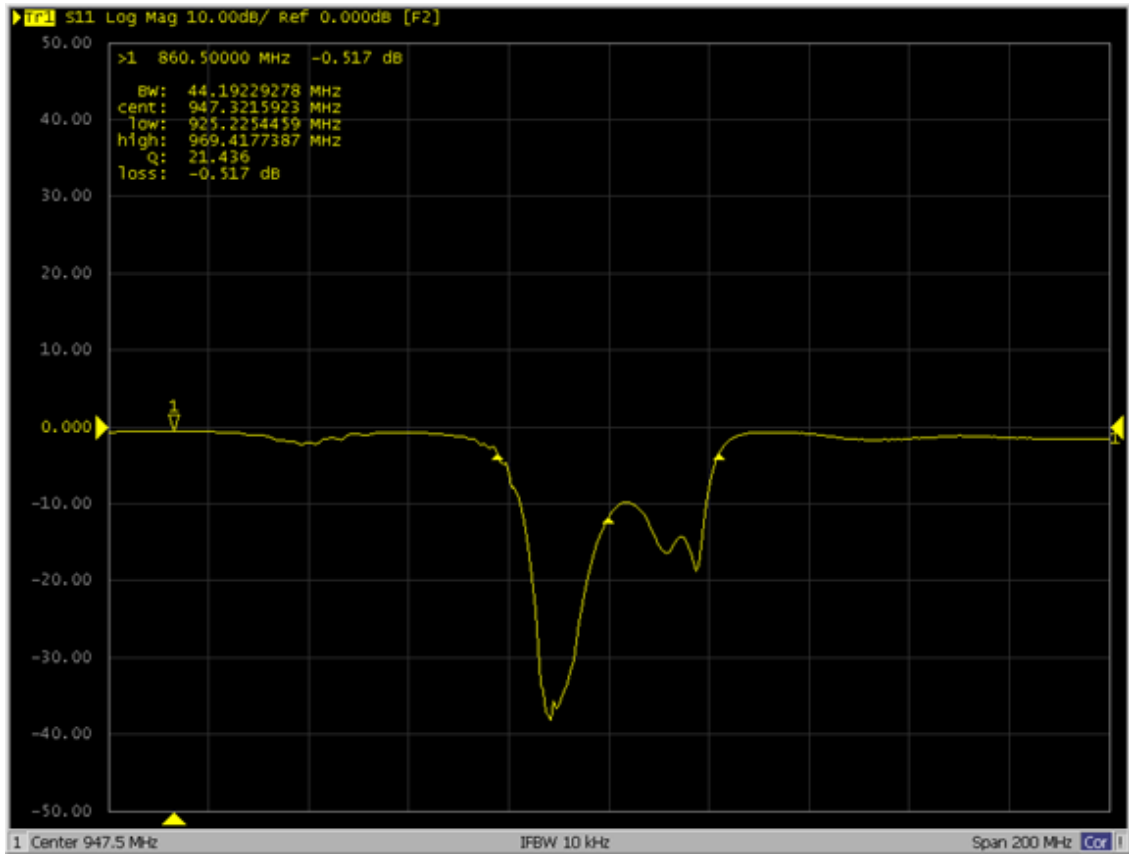

NOTE For more information on displaying the notch search result, see Notch Search

Determining the Mean, Standard Deviation, and p-p of the Trace

- [Overview](#)
- [Displaying Statistical Data](#)

Other topics about Data Analysis

Overview

You can easily determine the statistics data for a trace (span, mean, standard deviation, and peak-to-peak). The definitions for the statistics data elements are shown below. It is calculated within the range of markers 1 and 2. The markers 1 and 2 are activated automatically.

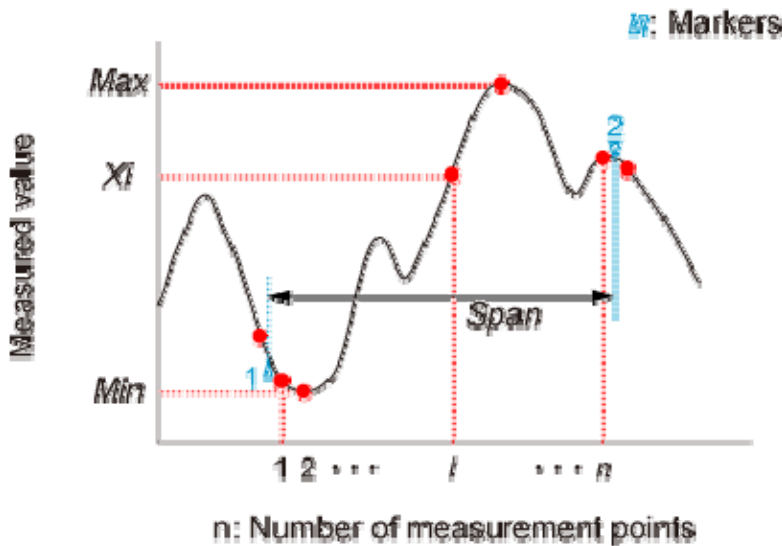

e5061b063

Statistics data element	Definition
Span	Span between markers 1 and 2.
Mean (<i>mean</i>)	$\frac{\sum_{i=1}^n x_i}{n}$ <p>(n: number of points between markers 1 and 2; x_i: measured value at the i-th measurement point between markers 1 and 2.)</p>

Standard deviation (s. dev)	$\sqrt{\frac{\sum_{i=1}^n (x_i - \text{mean})^2}{n-1}}$ <p>(n: number of points between markers 1 and 2; x_i: measured value at the i-th measurement point between markers 1 and 2.; mean: Mean)</p>
Peak-to-peak (ρ - ρ)	Max - Min (Max: greatest measured value between markers 1 and 2.; Min: smallest measured value between markers 1 and 2.)

NOTE

The search range does not affect this result.

Displaying Statistical Data

1. Press **Channel Next** (or **Channel Prev**) and **Trace Next** (or **Trace Prev**) to activate the trace of which the statistical data is required.
2. Press **Marker Fctn** > **Statistics** to turn ON the display of statistics data.
3. The markers 1 and 2 are activated automatically. Move markers 1 and 2 to the position of the measurement.

Obtaining Span, Gain, Slope, and Flatness between Markers

The span, gain, slope, and flatness between marker 1 and marker 2 on a trace can be obtained. The following figure shows data definitions.

Span, Gain Slope, and Flatness Parameters

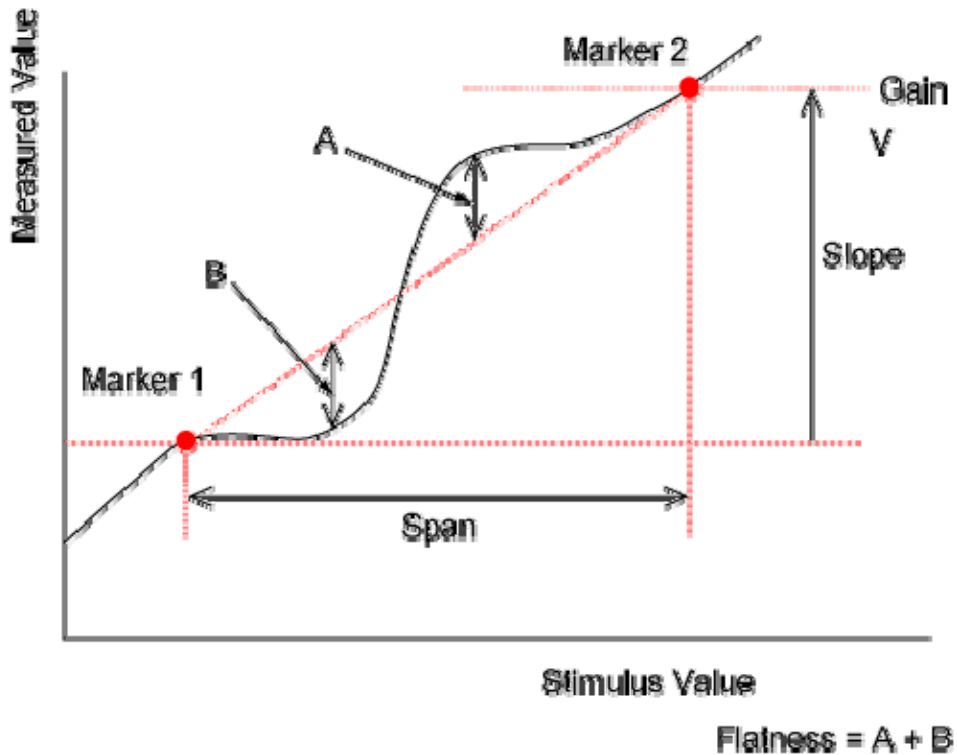

e5061b046

Data Name	Definition
Span	Calculates the distance between marker 1 and marker 2.
Gain	Calculates the larger measurement value between marker 1 and marker 2.
Slope	Calculates the differences in measurement value between marker 1 and marker 2. (marker 2 - marker 1)
Flatness	Calculates the sum of 2 maximum measurement value differences from the line connecting marker 1 and marker 2 (above and below the line).

1. Press **Channel Next** (or **Channel Prev**) and **Trace Next** (or **Trace Prev**) to activate the trace of which you want to obtain the data.
2. Press **Marker Fctn** > **Flatness** to show data.
3. Markers 1 through 2 are turned ON and displayed.
4. Set the positions of markers 1 through 2 on the trace.

Obtaining Loss, Ripple, and Attenuation of the RF Filter

Specify the pass band with markers 1 and 2 on the trace and specify the stop band with markers 3 and 4 to obtain loss, ripple, and attenuation. The following figure shows data definitions.

Loss, Ripple, and Attenuation Parameters

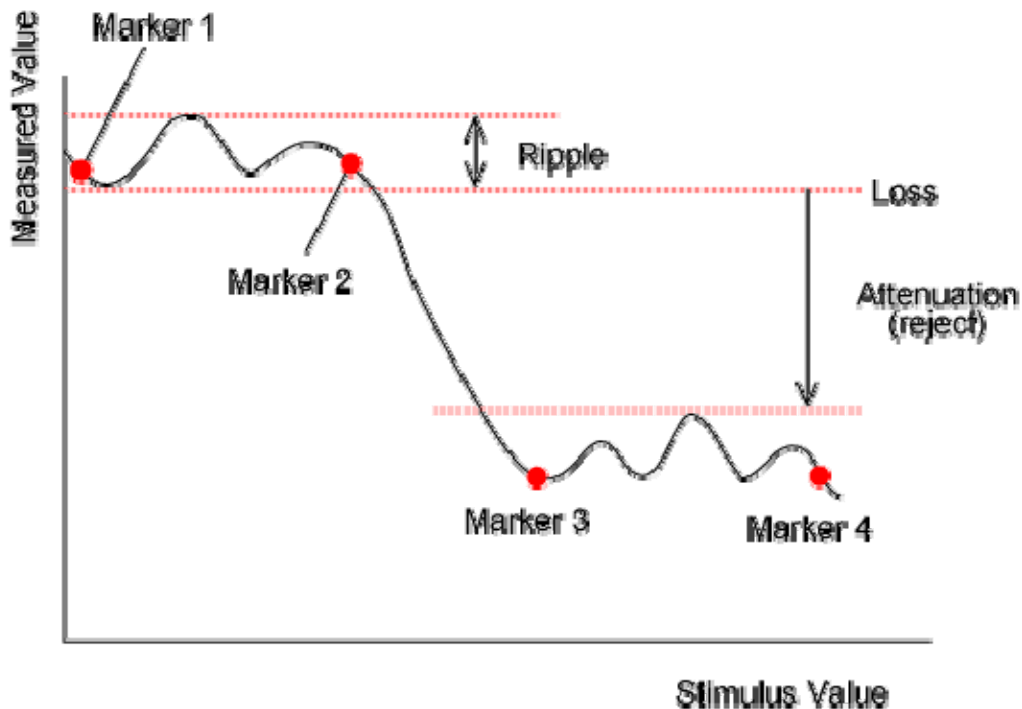

E5061B-45

Data Name	Definition
Loss (loss)	Calculates the minimum value between markers 1 and 2.
Ripple (p-p)	Calculates the differences between the maximum value and the minimum value of markers 1 and 2.
Attenuation (reject)	Calculates the differences between the maximum value between markers 3 and 4 and the minimum value (loss) between markers 1 and 2.

1. Press **Channel Next** (or **Channel Prev**) and **Trace Next** (or **Trace Prev**) to activate the trace of which you want to obtain the data.
2. Press **Marker Fctn** > **RF Filter Stats** to show the data.

3. Markers 1 through 4 are turned ON and displayed.
4. Set the positions of markers 1 through 4 on the trace.

Comparing Traces/Performing Data Math

- [Overview](#)
- [Performing Data Math Operations](#)

Other topics about Data Analysis

Overview

Each of the traces for which measured data is displayed is provided with an additional trace, called a memory trace, that temporarily stores measured data. You can use the memory trace to compare traces on the screen or to perform complex data math between the memory trace and measured data.

The following data math operations are available:

Value	Description
Data / Memory	Divides the measured data by the data in the memory trace. This function can be used to evaluate the ratio of two traces (e.g., evaluating gain or attenuation).
Data * Memory	Multiplies the measured data by a memory trace.
Data - Memory	Subtracts a memory trace from the measured data. This function can be used, for example, to subtract a vector error that has been measured and stored (e.g., directivity) from data subsequently measured on a device.
Data + Memory	Adds the measured data and the data in the memory trace.

Performing Data Math Operations

1. Press **Channel Next** (or **Channel Prev**) and **Trace Next** (or **Trace Prev**) to activate the trace to be stored in memory.
2. Press **Display** > **Data** -> **Mem** to store the measured data in memory.
3. Press **Data Math**.
4. Select the **data math** operation to perform.
5. Press **Display**.
6. Select the **type of data** to display ON the screen.
7. Send the trigger to make measurements.

Performing Parameter Conversion of Measurement Results

- [Overview](#)
- Turning Conversion ON
- Selecting Conversion Target Parameter

Other topics about Data Analysis

Overview

You can use the parameter conversion function to convert the measurement results of the S-parameter (S_{ab}) to the following parameters.

- Equivalent impedance (Z_r) and equivalent admittance (Y_r) in reflection measurement

$$Z_r = Z_{0a} \times \frac{1 + S_{aa}}{1 - S_{aa}}, Y_r = \frac{1}{Z_r}$$

- Equivalent impedance (Z_t) and equivalent admittance (Y_t) in transmission measurement

$$Z_t = \frac{2 \times \sqrt{Z_{0a} \times Z_{0b}}}{S_{ab}} - (Z_{0a} + Z_{0b}), Y_t = \frac{1}{Z_t}$$

- Inverse S-parameter ($1/S_{ab}$)

where:

Z_{0a} : Characteristic impedance of port a

Z_{0b} : Characteristic impedance of port b

- Z/Y Transmission Shunt

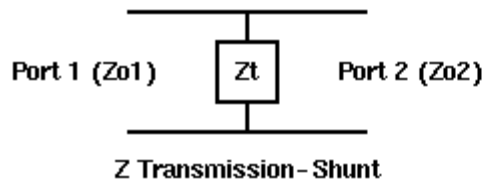

$$Z_t = \frac{1}{Y_t}$$

$$Y_t = \frac{2\sqrt{Y_{o1} \cdot Y_{o2}}}{S} - (Y_{o1} + Y_{o2})$$

$$Y_{o1} = \frac{1}{Z_{o1}} \quad Y_{o2} = \frac{1}{Z_{o2}}$$

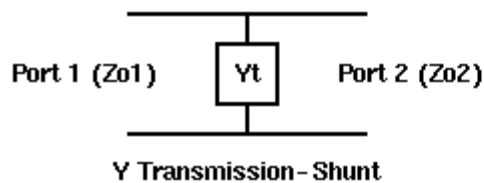

- Conjugation

Conjugation converts the measurement value to complex conjugate number.

When the fixture simulator function is ON and the port impedance function is ON, the value set in the port impedance conversion is used. In other cases, the system Z_0 (preset value: 50 Ω) is used.

Turning Conversion ON

1. Press **Channel Next** (or **Channel Prev**) and **Trace Next** (or **Trace Prev**) to activate a trace of which you want to use the marker.
2. Press **Analysis** > **Conversion**.
3. Click **Conversion** to turn ON the conversion function.

Selecting Conversion Target Parameter

1. Press **Channel Next** (or **Channel Prev**) and **Trace Next** (or **Trace Prev**) to activate a trace of which you want to use the marker.
2. Press **Analysis** > **Conversion** > **Function**.
3. Select the **parameter** to which you want to convert the result.

When the conversion function is ON, the selected parameter is displayed in Trace Status Area.

Using Limit Test

- [Overview](#)
- Concept of Limit Test
- [Displaying Judgement Result of Limit Test](#)
- [Defining Limit Line](#)
- Changing the Limit Line Display Mode
- Using Relative Limit Line
- Adding Offset to Limit Line
- Initializing the Limit Table

Other topics about Data Analysis

Overview

The limit test feature allows you to set the limit line for each trace and then perform the pass/fail judgment for the measurement result.

Concept of Limit Test

The limit test is a function to perform pass/fail judgment based on the limit line you set with the limit table.

In the limit test, if the upper limit or lower limit indicated by the limit line is not exceeded, the judgment result is pass; if it is exceeded, the judgment result is fail for all measurement points on the trace. Measurement points in a stimulus range with no limit line are judged as pass.

NOTE The targets of the pass/fail judgment are measurement points only. Parts interpolated between the measurement points are not judged.

You define the limit line by specifying the stimulus value (Begin Stimulus) and response value (Begin Response) of the begin point, the stimulus value (End Stimulus) and response value (End Response) of the end point, and the type (lower limit/upper limit). For more information, refer to Defining the limit line.

When the limit test is ON, measurement points that fail are displayed in red on the screen and the trace's pass/fail judgment result based on the results of individual measurement points (fail if one or more measurement points on the trace fail) is also displayed. You can check the pass/fail judgment result for the channel (fail if one or more traces fail in any of the limit test, the ripple test or the bandwidth test within the channel) on the screen as well. For more information, refer to Displaying judgment result of limit test.

In addition to viewing the screen, you can check the judgment result of the limit test with the following methods.

- Beep that occurs when the judgment result fails.
- Using the status register.

Displaying Judgment Result of Limit Test

Judgment result of measurement points and trace

Measurement points that fail are displayed in red on the screen. The judgment result of the trace is indicated by Pass or Fail displayed in the upper right section of the graph.

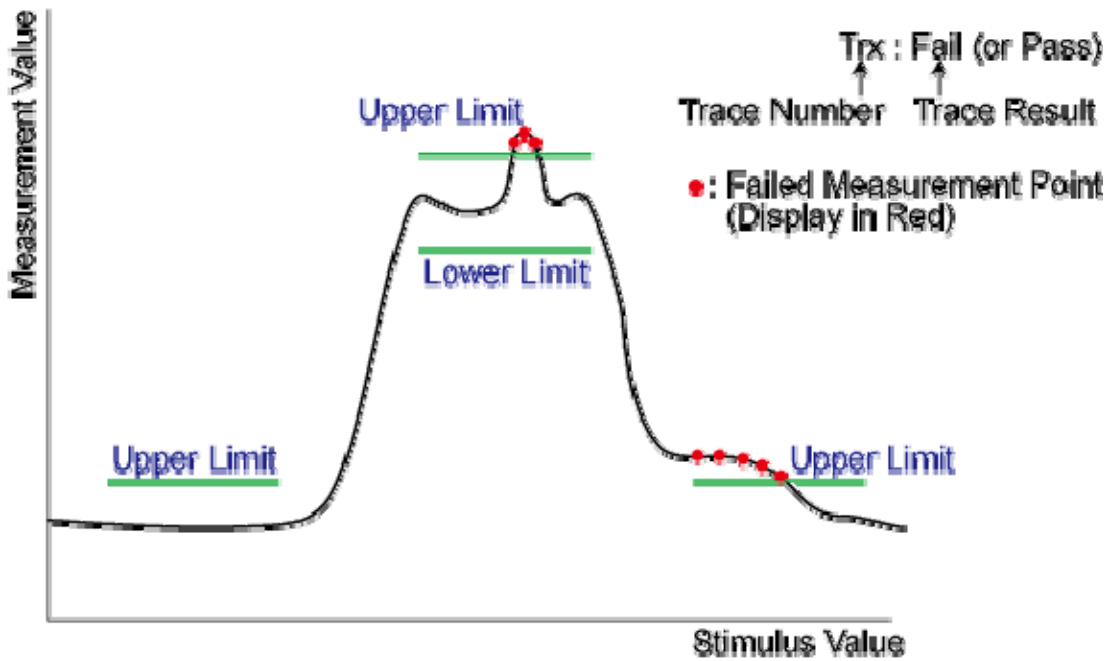

e5071c446

Judgment result of channels

If a channel has a judgment result of fail, the message below appears on the screen (it will be judged as fail if one or more unsatisfactory trace exist in any of the limit test, the ripple test or the bandwidth test within the channel.)



Follow these steps to turn ON/OFF the display of the channel fail message.

1. Press **Analysis** > **Limit Test**.
2. Click **Fail Sign**. Each press toggles between ON/OFF.

Defining Limit Line

To use the limit test, you must first define the limit line. You can define a limit table for each trace, and you can define up to 100 limit lines (segments) in a limit table.

Defining a segment

The following steps describe how to define a segment.

1. Press **Channel Next** (or **Channel Prev**) and **Trace Next** (or **Trace Prev**) to select the trace on which the limit test function is used.
2. Press **Analysis** > **Limit Test**.
3. Click **Edit Limit Line** to display the limit table.

Segment Number	Type of Limit Line	Beginning Point of Stimulus	End Point of Stimulus	Beginning Point of Response	End Point of Response
	Type	Begin Stimulus	End Stimulus	Begin Response	End Response
1	MAX	880.0000000 MHZ	900.0000000 MHZ	-48 dB	-48 dB
2	MAX	937.0000000 MHZ	961.0000000 MHZ	2 dB	2 dB
3	MIN	937.0000000 MHZ	961.0000000 MHZ	-5 dB	-5 dB
4	MAX	982.0000000 MHZ	1.000000000 GHZ	-32 dB	-32 dB
5	OFF	1.010000000 GHZ	1.030000000 GHZ	-48 dB	-48 dB
6					

4. Using the limit table, create/edit a segment. Initially, no segments are entered in the limit table. At the same time, the Edit Limit Line menu used to create/edit the limit table is displayed.
5. Click **Add** to add a segment to the limit table and then specify the segment parameter values shown below.

Segment Parameter	Description
Type	Select the type of segment from the following: OFF Segment not used for the limit test MIN Segment at which the minimum is specified

	MAX Segment at which the maximum is specified
Begin Stimulus	Specify starting point for stimulus value on the limit line
End Stimulus	Specify ending point for stimulus value on the limit line
Begin Response	Specify starting point for response value on the limit line
End Response	Specify ending point for response value on the limit line

NOTE

The range in which stimulus values can be specified is from -500 G to +500 G. When a value outside the range is entered, a suitable value within the range is specified. Once the stimulus value is specified, changing the sweep range of the E5061B does not affect the stimulus value.

NOTE

The range in which response values can be specified is from -500 M to +500 M. When a value outside this range is entered, a suitable value within the range is specified. After the response value is specified, changing formats results in changing the units but not the value.

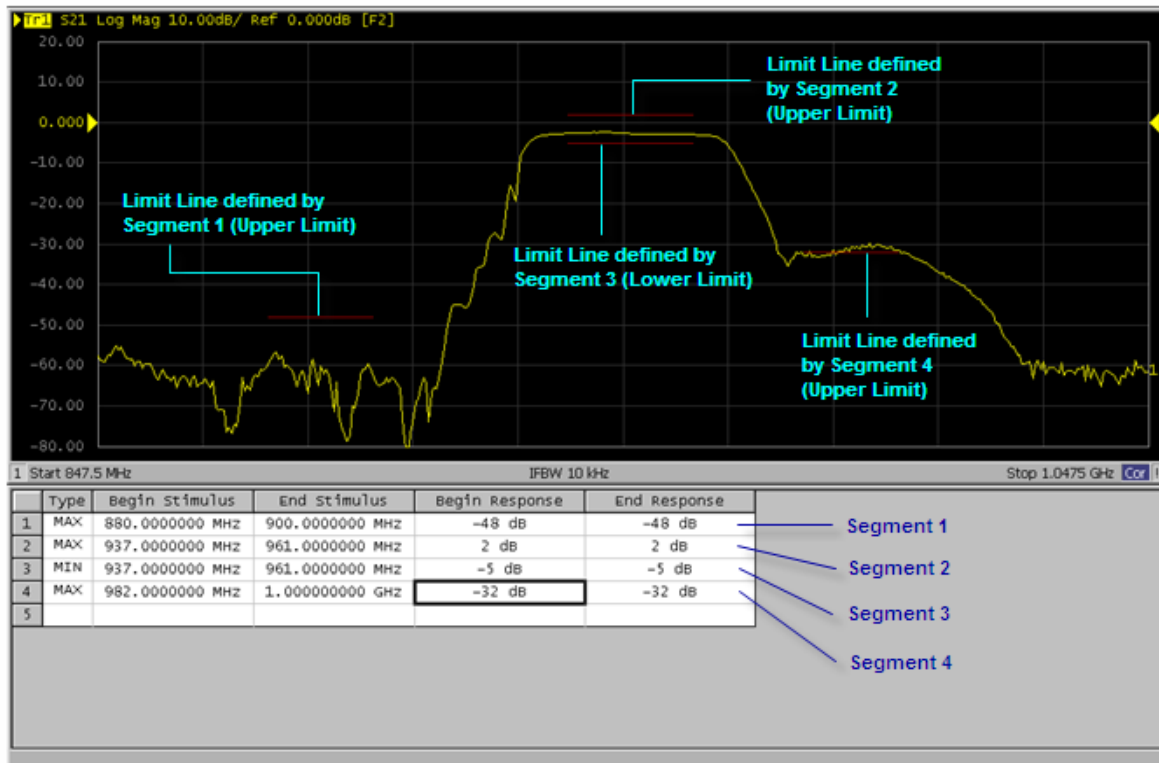

NOTE You can define a limit line that is able to freely overlap the stimulus range of another limit line.

Defining one limit line that has the same type as a second limit line whose stimulus range overlaps with the first one results in two or more limit values at the same measurement point. In this case, the limit value to be used in the limit test is defined as follows:

- When two or more limit values of which the type is set to maximum (MAX) exist, the smallest one is used as the maximum.
- When two or more limit values of which the type is set to minimum (MIN) exist, the largest one is used as the minimum.

NOTE Even if the span of the sweep range on the E5061B is set to 0, enter the two parameters of Begin Stimulus and End Stimulus.

NOTE When two or more response values are returned as a result of using the Smith or polar chart format, the first response value of the marker provides the object of the limit test.

Saving/calling the limit table

You can save the limit table to a file that you can then freely bring up on the screen later and use. You can import a file saved in CSV format (extension: *.csv) into spreadsheet software on a PC for later use (a numerical value is saved as strings that includes its unit).

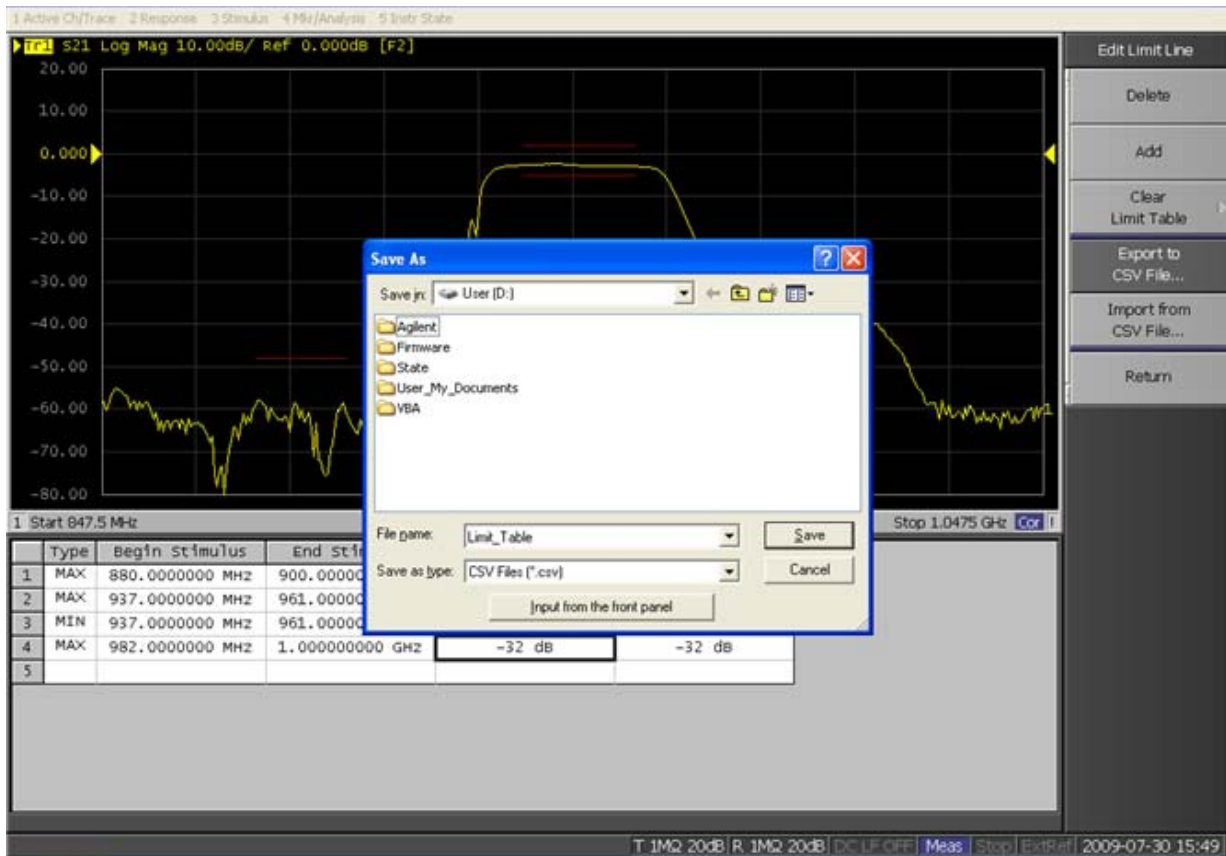

1. Display the limit table.
2. In the Edit Limit Line menu, press **Export to CSV File** to open the Save As dialog box. In this step, CSV (extension: *.csv) is selected as the file type.
3. Specify the folder in which to save the file and enter the file name. Press **Save** to save the limit table displayed on the screen to the file.
4. Conversely, to recall a saved limit table, press **Import from CSV File** in the Edit Limit Line menu to display the Open dialog box. In this step, CSV (extension: *.csv) is selected as the file type.
5. After specifying the folder containing the file, select the file. Press **Open** to display the limit table on the screen.

NOTE The limit table can be called from any trace of any channel, regardless of the channel or trace.

Limit Table Saved in CSV Format

The limit table is saved in the following format.

- On the first line, the channel number of the active channel that is valid when the saved file is the output.

- On the second line, the trace number of the active trace that is valid when the saved file is the output.
- The third line provides the header showing the items for the segments to be output on the fourth and later lines.
- Data on segments are output on the fourth and later lines.

"# Channel 1"

"# Trace 1"

Type, Begin Stimulus, End Stimulus, Begin Response, End Response

MAX, 200.0000000 MHz, 400.0000000 MHz, -100 dB, -100 dB

MAX, 490.0000000 MHz, 510.0000000 MHz, -10 dB, -10 dB

MIN, 490.0000000 MHz, 510.0000000 MHz, -20 dB, -20 dB

MIN, 600.0000000 MHz, 800.0000000 MHz, -100 dB, -100 dB

Turning the limit test ON/OFF

You can set the limit test ON/OFF for each trace individually.

1. Press **Channel Next** (or **Channel Prev**) and **Trace Next** (or **Trace Prev**) to select the trace on which the limit test function is used.
2. Press **Analysis** > **Limit Test** to display the Limit Test menu.
3. Press **Limit Test** to set the limit test ON/OFF.
4. Press **Limit Line** to set the limit line display ON/OFF.

Changing the Limit Line Display Mode

You can specify the limit line display mode hide limit values that are not used for evaluation.

Changing the display mode:

1. Press **Channel Next** (or **Channel Prev**) and **Trace Next** (or **Trace Prev**) to activate the channel of which you want to use the limit test function.
2. Press **Analysis** > **Limit Test**.
3. Turn off **Limit Line**.
4. Press **Clip Lines** to toggle ON/OFFf.

Limit line display mode

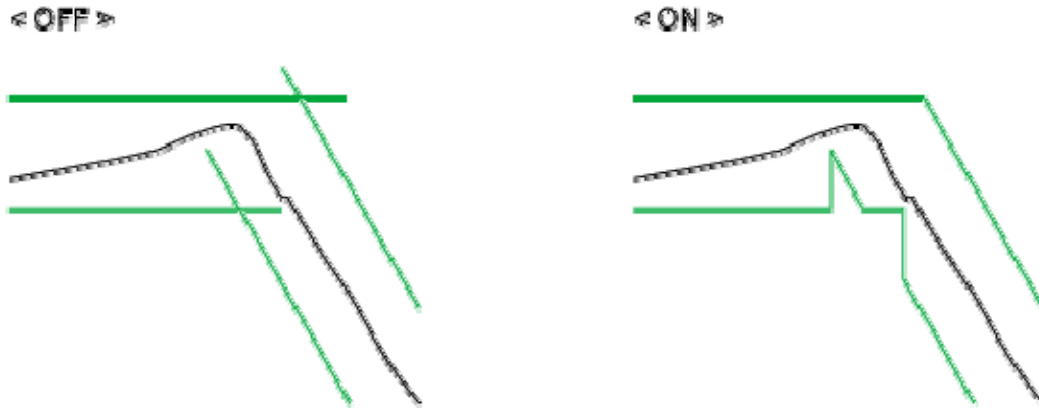

E5061B057

Using Relative Limit Line

If the shape is more important than the amplitude, you can make the limit lines relative to the peak point of the trace using the reference tracking function.

In this function, the point to be tracked is set as the Y-axis reference value by offsetting measurement values after the sweep. Because measurement values are offset, marker values and limit test evaluation results change accordingly.

1. Press **Channel Next** (or **Channel Prev**) and **Trace Next** (or **Trace Prev**) to select the channel/trace.
2. Press **Scale** > **Reference Tracking**.
3. When you want to specify a measurement value at a frequency as the Y-axis reference value for tracking, press **Track Frequency**, then enter the frequency.
4. Press **Tracking** to select a **tracking method**.
5. **PTrk** (Track Peak) or **FTrk** (Frequency) is displayed at the trace status area.

NOTE

This function is available even when the limit test function is off.

Adding Offset to Limit Line

By adding a certain offset to the limit value, you can adjust the limit line so that it conforms to the device output.

1. Press **Channel Next** (or **Channel Prev**) and **Trace Next** (or **Trace Prev**) to select the channel/trace on which the limit test function is used.
2. Press **Analysis** > **Limit Test** to display the softkeys for the limit test.

- Click **Limit Line Offsets** to display the **limit line offset function menu**.

Stimulus offset

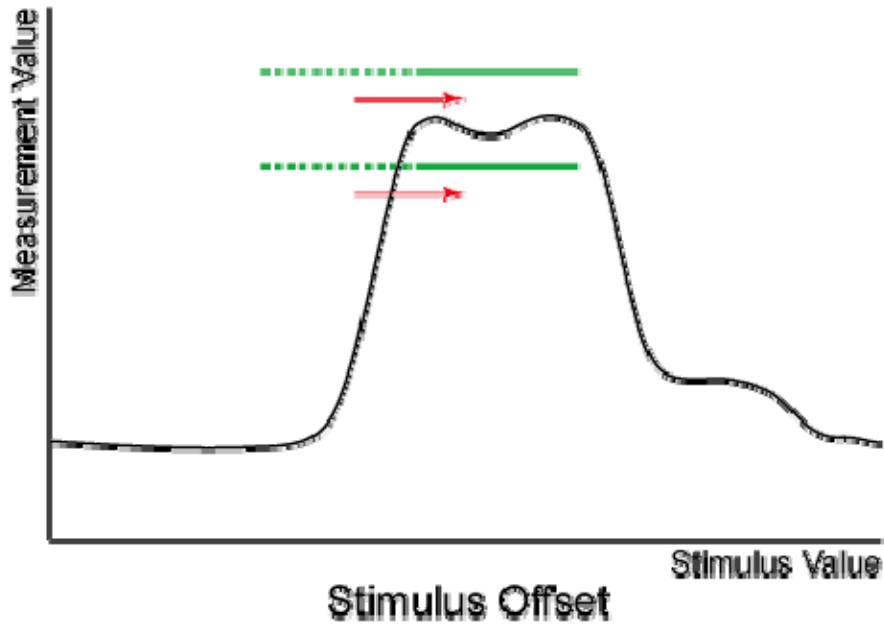

e5071c447

Amplitude offset

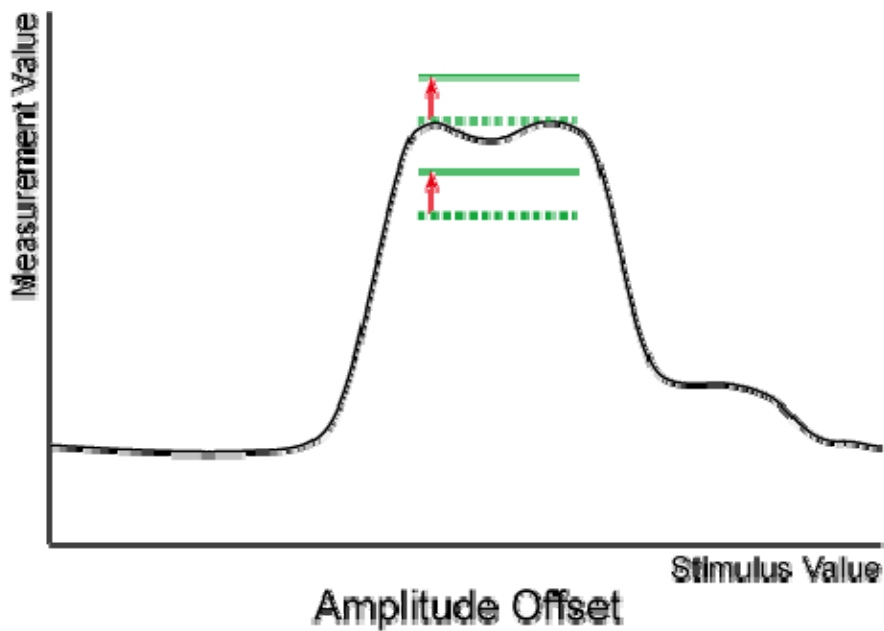

e5071c448

Initializing the Limit Table

The following operations initialize the limit table.

- At power-on
- When presetting
- When calling a limit table with zero segments
- When **Clear Limit Table** > **OK** is pressed in the Edit Limit Line menu

Using Bandwidth Test

- [Overview](#)
- Displaying Bandwidth Test Results
- Bandwidth Test Setup
- [Turning Bandwidth Test and Displaying Results ON/OFF](#)

Other topics about Data Analysis

Overview

The bandwidth test function can be used to test bandwidth for the band-pass filters.

The bandwidth test find the peak of a signal in the passband and locates a point on each side of the passband at an amplitude below the peak specified in test setup. The frequency between these two points is the bandwidth of the filter. Then the obtained bandwidth is compared to minimum and maximum allowable bandwidth that you specify beforehand.

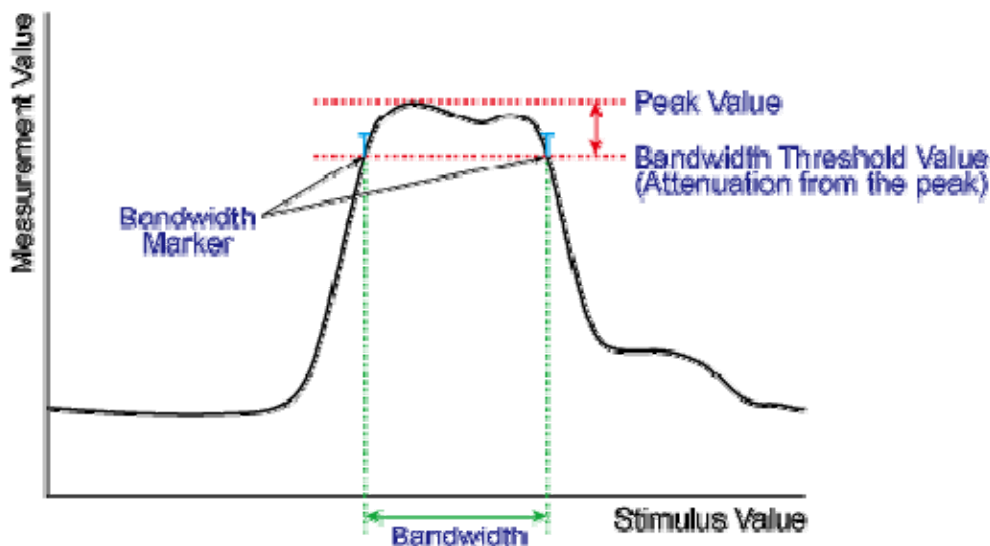

e9071c450

Displaying Bandwidth Test Results

Test Result for Trace

The test result of the trace is indicated in the upper-right section of the graph for each trace, following BWn:.. "n" denotes the trace number. The results are shown as Pass, Wide, Narrow, or >Span (Fail). You can also choose to display the bandwidth value.

For information on how to display the results, see [Turning On/Off Bandwidth Test and Displaying Results](#).

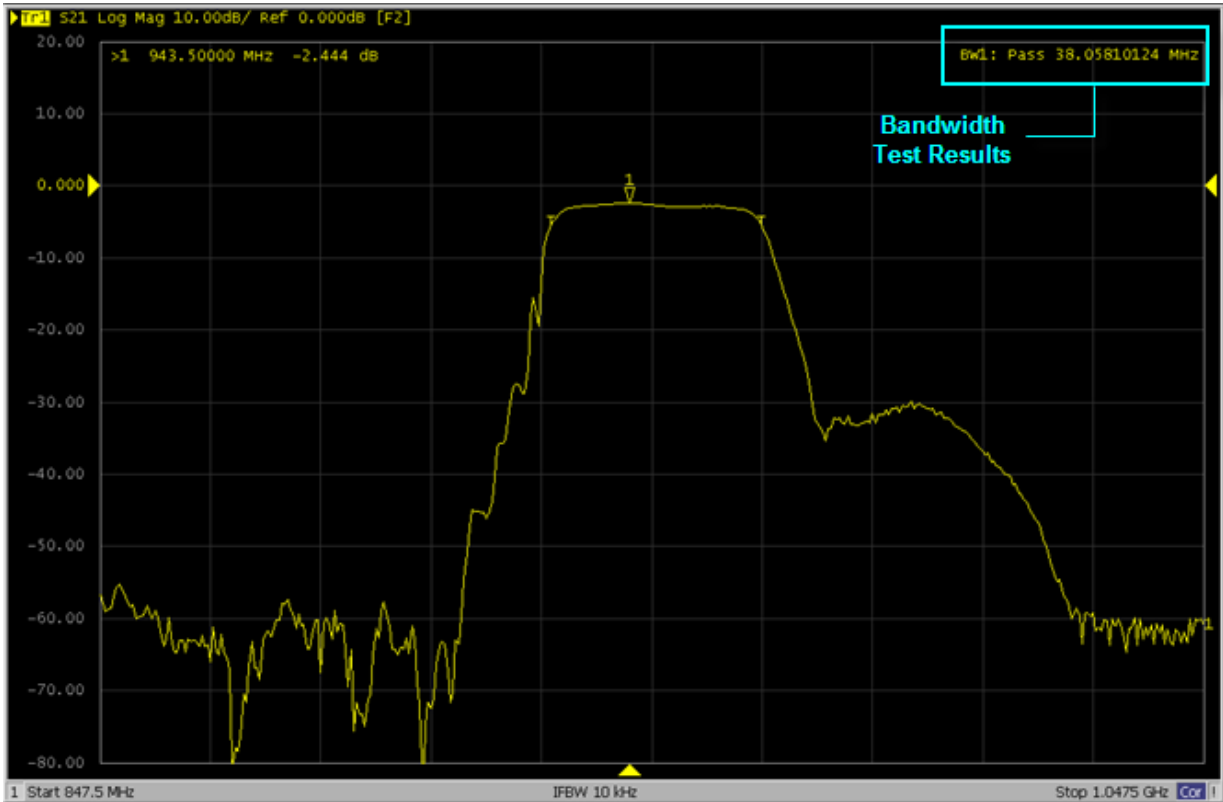

Test Results for Channel

If any channel is unsatisfactory, a message is displayed as shown in Judgment result of channels. (It is judged as failed if one or more failed traces are found for the limit test, ripple test, or bandwidth test within the channel.)

You can also specify this ON/OFF setting from the Fail Sign, which is provided in the limit test menu and ripple test menu. From the bandwidth test menu, follow the steps below to turn it ON/OFF.

1. Press **Analysis** key.
2. Click **Bandwidth Limit**.
3. Click **Fail Sign**. This menu toggles between ON and OFF.

In addition to the screen, the following features also let you confirm the test results:

- Beep notifying that the result is unsatisfactory
- Status register

Bandwidth Test Setup

You must set up the bandwidth threshold and the upper and lower limits before you can use the bandwidth test function. You can specify the threshold, upper limit, and lower limit for each trace.

Follow the steps below to set up the bandwidth test.

1. Press **Channel Next** (or **Channel Prev**) and **Trace Next** (or **Trace Prev**) to activate the trace for which you want to apply the bandwidth test function.
2. Press **Analysis** key to display the Analysis menu.
3. Click **Bandwidth Limit > N dB Points** to specify the bandwidth threshold. The unit is dB.
4. Press **Min Bandwidth** to enter the lower limit for the bandwidth. Similarly, press **Max Bandwidth** to enter the upper limit for the bandwidth. The unit is Hz for both Min and Max bandwidths.

NOTE

If the data format is Smith chart or polar, the limit test is performed for the main response value among the two marker response values.

Turning Bandwidth Test and Displaying Results ON/OFF

You can configure the ON/OFF setting of the bandwidth test function for each trace independently.

Follow the steps below to configure the ON/OFF setting of the bandwidth test.

1. Press **Channel Next** (or **Channel Prev**) and **Trace Next** (or **Trace Prev**) to activate the trace of which you want to apply the bandwidth test function.
2. Press **Analysis** key to display the Analysis menu.
3. Click **Bandwidth Limit > BW Test** to turn ON the bandwidth test.
4. Click **BW Marker** to turn ON so that the bandwidth marker is displayed on the screen.
5. Click **BW Display** to turn ON so that the bandwidth value is displayed.

Using Ripple Test

- [Overview](#)
- [Concept of Ripple Test](#)
- [Displaying Ripple Test Results](#)
- [Configuring Ripple Limit](#)
- [Saving/Recalling Ripple Limit Table](#)
- [Turning ON/OFF Ripple Test and Result Display](#)
- [Initializing Limit Table](#)

Other topics about Data Analysis

Overview

Independent of the limit test, you can evaluate the measurement results on a pass/fail basis by setting a limit for the ripple. This function is called the ripple test.

Concept of Ripple Test

The ripple test is a function for evaluating the results on a pass/fail basis based on the ripple limit, which is set using the ripple limit table. You can specify up to 12 frequency bands, which permits a test for each frequency band.

The ripple test judges the measurement as "Pass" when the ripple value specified with the ripple limit does not exceed any of the measurement points on the trace; otherwise, it judges the measurement as "Fail." For the measurement points in a stimulus range without a specified ripple limit, the test judges the measurement as "Pass."

NOTE

The measurement point alone is the target of evaluation for pass/fail. The interpolated part between measurement points is not evaluated.

The ripple limit is defined with the start point stimulus value, end point stimulus value, ripple limit value, and type (ON/OFF). For detailed information, see Configuring ripple limit.

While the ripple test function is turned ON, the measurement points corresponding to a "fail" judgment is indicated in red on the screen, and the trace's test results based on the results of each measurement point is displayed (judged as "fail" if one or more red measurement point exist on the trace). For information on how to display the results, see Turning ON/OFF ripple test and displaying results. You can also confirm the channel

test results on the screen (judged as "fail" if one or more failed traces appear in the limit test, ripple test, or bandwidth test within the channel).

Displaying Ripple Test Results

Measurement point and test results

Failed measurement points is displayed in red on the screen. The test result for the trace is indicated as Pass or Fail in the upper-right section of the graph. You can also display the ripple value at the selected frequency band.

The result is displayed as RipIn:Pass (or Fail) for each trace. n denotes the trace number. Bn is followed by the ripple value (if the ripple display is turned OFF, only Bn is displayed without the ripple value).

For example, in the following figure, Rip1:Pass in the first line indicates the result for trace 1. The value following B3 is the ripple value at the third frequency band specified in the ripple test. Similarly, the second line indicates the test result for trace 2, showing the ripple value at the first frequency band.

For information on how to display the results, see Turning ON/OFF ripple test and displaying results.

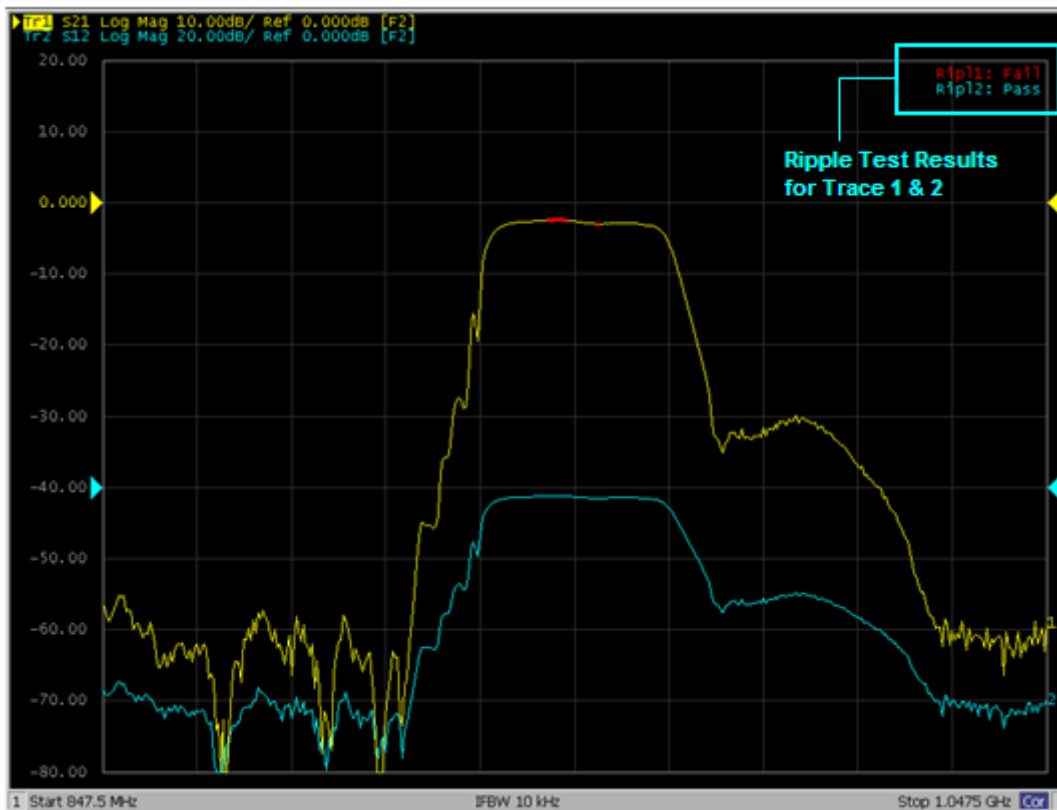

Test result for channel

If a channel has a judgment result of "fail", the message is displayed as shown in Test Result for Trace. (It is judged as failed if one or more failed traces are found in the limit test, ripple test, or bandwidth test within the channel.)

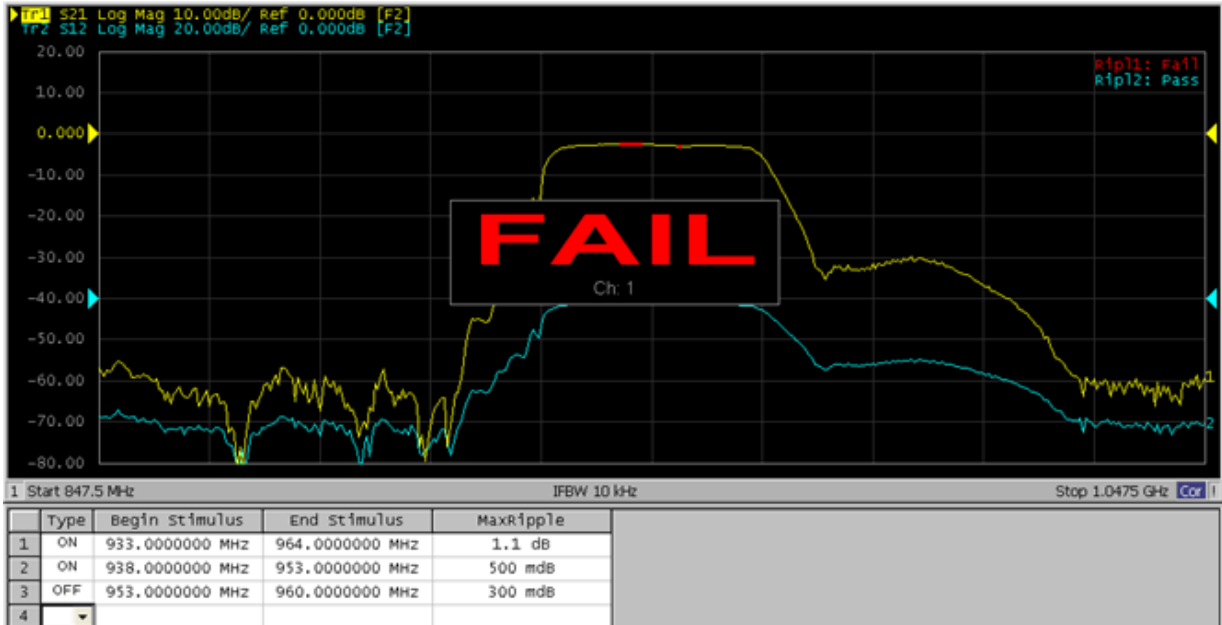

You can also specify the ON/OFF setting for the Fail Sign in the limit test menu and as well as in the bandwidth test menu. From the ripple test menu, follow the steps below to turn it ON/OFF.

1. Press **Analysis** > **Ripple Limit**.
2. Click **Fail Sign**. This menu toggles between ON and OFF.

In addition to the screen, the following features also let you confirm the test results:

- Beep notifying that the result is "fail"
- Status register

Configuring Ripple Limit

You must configure the ripple limit before you can use the ripple test function. You can specify a ripple limit table for each trace, where up to 12 ripple limit bands (frequency bands) can be configured.

Operational procedure

Follow the steps below to configure the ripple limits.

1. Press **Channel Next** (or **Channel Prev**) and **Trace Next** (or **Trace Prev**) to select the trace on which you want to apply the ripple test function.
2. Press **Analysis** > **Ripple Limit**.

- Click **Edit Ripple Limit** to display the ripple limit table shown below.

	Type	Begin stimulus	End stimulus	MaxRipple
1	ON	933.0000000 MHz	964.0000000 MHz	1.1 dB
2	ON	938.0000000 MHz	953.0000000 MHz	500 mdB
3	OFF	953.0000000 MHz	960.0000000 MHz	300 mdB
4				

- Click **Add** to add a frequency band to the ripple limit table and then specify the **parameters** for the frequency band. Note that no frequency band is provided in the ripple limit table by default. Click **Delete** to delete the selected frequency band and **Clear Ripple Limit Table** to clear the table setting.

NOTE Acceptable range for the stimulus value: -500G to +500G. If any outranging value is specified, it is reset to fall within the range.

NOTE Even if the E5061B's sweep range is changed after the stimulus value has been set, the stimulus value is not susceptible.

Example of ripple limit configuration

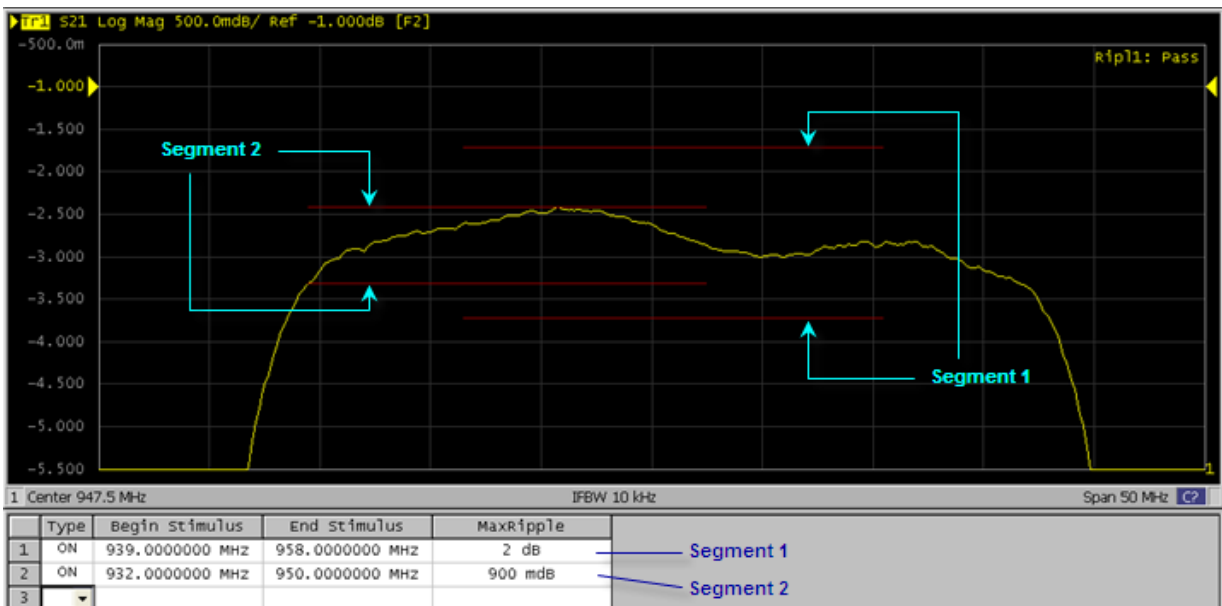

NOTE The individual frequency bands for the ripple test can overlap each other; in this case, the ripple limit test is performed for each frequency band.

NOTE Even if the E5061B's span value is set to zero, you must enter a parameter for both Begin Stimulus and End Stimulus.

NOTE If the data format is Smith chart or polar, the limit test is performed for the main response value among the two marker response values.

Saving/Recalling Ripple Limit Table

The ripple limit table can be saved in a file and recalled later for use on the screen. The file is saved in the csv format (with the extension *.csv), and values are saved as a character string with the unit. The csv formatted file can also be reused in spreadsheet software made for PCs.

Follow the steps below to save/recall the ripple limit table. This operation should be done by using the external keyboard and/or mouse.

1. Display the ripple limit table.
2. Click **Export to CSV File** from the Edit Ripple Limit menu to open the dialog box. At this time, CSV file (with the extension *.csv) is selected as the file type.
3. Specify any folder in which you want to save the file, and enter the file name. Click **Save** to save the ripple limit table displayed on the screen to a file.
4. To recall the saved ripple limit table, click **Import from CSV File** from the Edit RippleLimit menu to display the Open dialog box. At this time, CSV file (with the extension *.csv) is selected as the file type.
5. Specify the folder that contains the file, and then select the file. Click **Open** to recall the saved limit table on the screen.

NOTE You can recall a limit table from a trace on any channel independently of the channel and trace that are active when the limit table is saved to the file.

The ripple limit table is saved in the following format:

- In the first line, the channel number for the active channel at the time of file saving will be output.
- In the second line, the trace number for the active trace at the time of file saving will be output.
- The third line is a header indicating the segment items that are output from the fourth line onwards.
- From the fourth line onwards, the segment data are output.

Operational procedure

"# Channel 1"

"# Trace 1"

Type, Begin Stimulus, End Stimulus, MaxRipple

ON, 933.0000000 MHz, 964.0000000 MHz, 1.5 dB

ON, 938.0000000 MHz, 953.0000000 MHz, 500 mdB

ON, 953.0000000 MHz, 960.0000000 MHz, 300 mdB

Turning ON/OFF Ripple Test and Result Display

You can set the limit test ON/OFF for each trace individually.

1. Press **Channel Next** (or **Channel Prev**) and **Trace Next** (or **Trace Prev**) to select the trace on which you want to apply the ripple test function.
2. Press **Analysis** > **Ripple Limit**.
3. Press **Ripple Limit Test** to set the ripple test ON.
4. Press **Ripple Limit** to display the ripple limit line.
5. Press **Ripple Value** to shows how the ripple values are displayed, then select **Absolute** (difference between maximum and minimum values within the band), **Margin** (difference between absolute value of ripple and ripple limit), or **OFF**.
6. Press **Ripple Value Band** to select the band for which you want to display the ripple value.

Initializing Limit Table

The following operations initialize the limit table.

- At power-on
- When presetting
- When calling a Ripple table with zero segments
- When **Clear Ripple Limit Table** > **OK** is clicked in the Edit Ripple Limit menu

Using Equation Editor

- [Overview](#)
- Using Equation Editor
- Equation Editor Examples
- Equation History
- [Functions and Constants](#)
- Converting S Parameters to H, Y, Z, F & T Parameters
- [Operators used in Equation Editor](#)

Other topics about Data Analysis

Overview

Equation Editor allows you to enter an algebraic equation of standard mathematical operators and functions, referencing data that is available in the E5061B. Once a valid equation is entered and enabled, the display of the active trace is replaced with the results of the equation, and updated in real-time as new data is acquired. For equations that can be expressed with Equation Editor's supported functions, operators, and data, there is no need for off-line processing in a separate program.

For example, on entering the equation "Example=S21/(1-S11)" in the E5061B Equation Editor (**4** in the Figure below), the resulting trace is computed as each S21 data point divided by one minus the corresponding S11 data point. For a 201 point sweep setup, the computation is repeated 201 times, once for each point.

Using Equation Editor

The step-by-step procedure of using Equation Editor is described below:

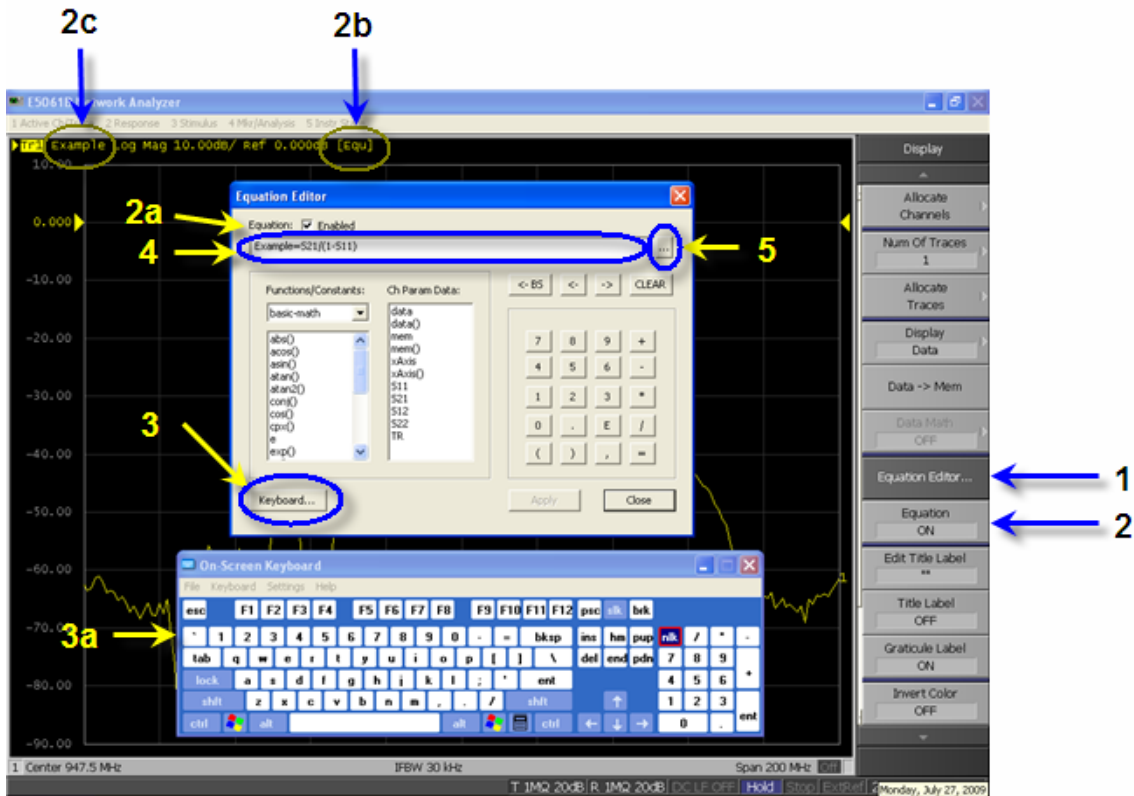

NOTE The parameter of **Z** is available in **Ch Param Data** when option 005 is installed.

Equation Editor Dialog box

1. Select a trace in which you want to enter the equation and activate the trace.

NOTE Activating a trace is required as Equation Editor works on traces.

2. Follow the steps below to enter an equation:
 1. Press **Display**.
 2. Click **Equation Editor** (1 in the figure above). The Equation Editor dialog box appears.
 3. Enter an equation in the equation field (4 in the figure above).

NOTE Referring to traces in a different channel is NOT available with Equation Editor on the ENA.

NOTE The equation can be entered with the software keyboard enabled by selecting **Keyboard...** (3 and 3a in the figure above).

3. Follow the steps below to apply the defined equation. When a valid equation is entered, the Equation Enabled check box becomes available for checking.
 1. Check **Equation Enabled** check box (**2a** in the figure above).
 2. Click **Apply**. The equation becomes visible and annotation of [Equ] (**2b** in the figure above) is displayed in the trace title area.
 3. Click **Close** to hide the dialog box.

NOTE The equation can also be applied by selecting **Display > Equation ON**.

NOTE If error correction is not turned ON, then the raw, uncorrected data is used in the equation trace.

NOTE If an equation is NOT valid (i.e. referring to a trace that is not measured in the measured channel), annotation of [Equ!] is displayed in the trace title area instead.

Equation Editor Examples

The following examples may help you in getting started with Equation Editor. Input the equation example in the equation field (**4** in Equation Editor dialog box).

Description	Equation Example
Offset each data point in trace 2 from trace 1 by XdB	$Offset = data(1) * pow(10, X/20)$
Multiplying by X-times in log format	$XTimes = pow(data, X)$
Differential Return Loss	$Sdd11 = (S11 - S21 - S12 + S22) / 2$
CMRR of a Balanced Component	$CMRR = data(2) / data(1)$

Equation History

Equation Editor has the capability to save and recall all previously defined equations. All equations can be viewed in the Equation History dialog box.

To view the equations in the list, follow this procedure:

1. Open Equation Editor by **Display > Equation Editor**
2. Enter an equation and click **Apply** in the Equation Editor dialog box to save the defined equation in the directory of the E5061B. To view a list of saved equations, click the ... button (**5** in Equation Editor Dialog box) to open the Equation History dialog box.

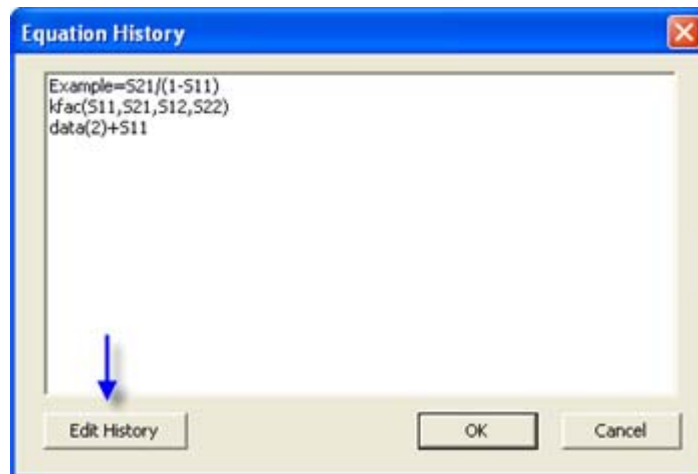
**NOTE**

To store an equation in the History List, the equation must be applied first. This can be done by clicking on the **Apply** button.

3. To edit the equations in the list, click **Edit History**. The text file of **history list** is opened with Notepad.

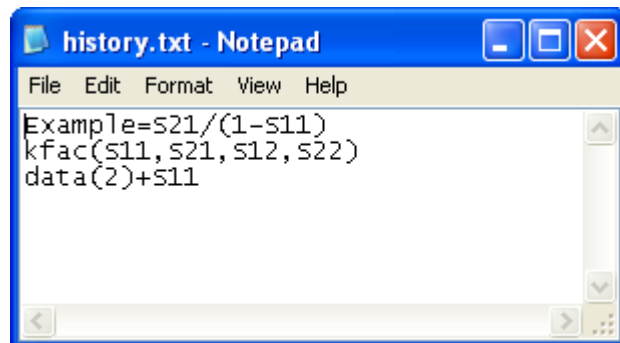
**NOTE**

The **History** List is stored as a text file **D:\Agilent\Equation\history.txt** and can save a maximum of 50 lines (equations) with a maximum of 254 character per line (equation).

Functions and Constants

The following table describes the different functions and constant available in the E5061B Equation Editor. In the following table:

- Function(scalar x) means that the function requires a scalar value. If a complex value is entered, it is automatically converted to a scalar value; complex(x,y) -> scalar(x)

- Function(complex x) means that the function requires a complex value. If a scalar value is entered, it is automatically converted to a complex value; scalar(x) -> complex(x, 0)
- a,b are arguments that are used in the function.

Basic Math Functions

Function	Description
abs(complex a)	returns the $\sqrt{a.re^2+a.im^2}$
acos(scalar a)	returns the arc cosine of a in radians
asin(scalar a)	returns the arc sine of a in radians
atan(scalar a)	returns the arc tangent of a in radians
atan2(complex a)	returns the phase of a = (re, im) in radians
atan2(scalar a , scalar b)	returns the phase of (a, b) in radians
conj(complex a)	returns the conjugate of a
cos(complex a)	takes a in radians and returns the cosine
cpx(scalar a , scalar b)	returns a complex value (a+ib) from two scalar values
exp(complex a)	returns the exponential of a
im(complex a)	returns the imaginary part of a as the scalar part of the result (zeroes the imaginary part)
ln(complex a)	returns the natural logarithm of a
log10(complex a)	returns the base 10 logarithm of a
mag(complex a)	returns $\sqrt{a.re^2+a.im^2}$
phase(complex a)	returns $\text{atan}^2(a)$ in degrees
pow(complex a , complex b)	returns a to the power b
re(complex a)	returns the scalar part of a (zeroes the imaginary part)

sin(complex a)	takes a in radians and returns the sine
sqrt(complex a)	returns the square root of a, with phase angle in the half-open interval $(-\pi/2, \pi/2)$
tan(complex a)	takes a in radians and returns the tangent
Constants	
e	2.71828182845904523536
PI	3.14159265358979323846

NOTE

Mutual transformation is automatically made for scalar and complex.

scalar(x) -> complex(x, 0)
 complex(x, y) -> scalar(x)

Advanced Math Functions

In the following table: **a,b,c,d** are arguments of complex value that are used in the function. For 2-port network measurement: **a,b,c,d** correspond to $S_{ii}, S_{ji}, S_{ij}, S_{jj}$ respectively.

NOTE

The functions can also be defined by scalar arguments with port numbers of the E5061B. For example, the function, $kfac(1,2)$ returns the K-factor of 2-port measurement between port 1 and port 2.

Z_0 refers to the system characteristic impedance which can be accessed under Cal.

Function	Description
A(complex a , complex b , complex c , complex d)	F_{11} conversion = $((1+a) \times (1-d) + b \times c) / (2 \times b)$
A(scalar i, scalar j)	returns A($S_{ii}, S_{ji}, S_{ij}, S_{jj}$)
B(complex a , complex b , complex c , complex d)	F_{12} conversion = $Z_0 \times ((1+a) \times (1+d) - b \times c) / (2 \times b)$
B(scalar i, scalar j)	returns B($S_{ii}, S_{ji}, S_{ij}, S_{jj}$)

C(complex a , complex b , complex c , complex d)	$F_{21} \text{ conversion} = (1/Z_0) \times ((1-a) \times (1-d) - b \times c) / (2 \times b)$
C(scalar <i>i</i> , scalar <i>j</i>)	returns C(Sii, Sji, Sij, Sjj)
D(complex a , complex b , complex c , complex d)	$F_{22} \text{ conversion} = ((1-a) \times (1+d) + b \times c) / (2 \times b)$
D(scalar <i>i</i> , scalar <i>j</i>)	returns D(Sii, Sji, Sij, Sjj)
H11(complex a , complex b , complex c , complex d)	$H_{11} \text{ conversion} = Z_0 \times ((1+a) \times (1+d) - b \times c) / ((1-a) \times (1+d) + b \times c)$
H11(scalar <i>i</i> , scalar <i>j</i>)	returns H11(Sii, Sji, Sij, Sjj)
H12(complex a , complex b , complex c , complex d)	$H_{12} \text{ conversion} = 2 \times c / ((1-a) \times (1+d) + b \times c)$
H12(scalar <i>i</i> , scalar <i>j</i>)	returns H12(Sii, Sji, Sij, Sjj)
H21(complex a , complex b , complex c , complex d)	$H_{21} \text{ conversion} = -2 \times b / ((1-a) \times (1+d) + b \times c)$
H21(scalar <i>i</i> , scalar <i>j</i>)	returns H21(Sii, Sji, Sij, Sjj)
H22(complex a , complex b , complex c , complex d)	$H_{22} \text{ conversion} = (1/Z_0) \times ((1-a) \times (1-d) - b \times c) / ((1-a) \times (1+d) + b \times c)$
H22(scalar <i>i</i> , scalar <i>j</i>)	returns H22(Sii, Sji, Sij, Sjj)
kfac(complex a , complex b , complex c , complex d)	$k\text{-factor} = (1 - \text{abs}(a)^2 - \text{abs}(d)^2 + (\text{abs}(a \times d - b \times c))^2) / (2 \times \text{abs}(b \times c))$
kfac(scalar <i>i</i> , scalar <i>j</i>)	returns kfac(Sii, Sji, Sij, Sjj)
MAPG(complex a , complex b , complex c , complex d)	maximum available power gain = $\text{abs}(b/c) \times (\text{kfac}(a,b,c,d) - \text{sqrt}(\text{kfac}(a,b,c,d)^2 - 1))$
MAPG(scalar <i>i</i> , scalar <i>j</i>)	returns MAPG(Sii, Sji, Sij, Sjj)
MSG(complex a , complex b , complex c , complex d)	maximum stable power gain = $\text{abs}(b)/\text{abs}(c)$

MSG(scalar <i>i</i> , scalar <i>j</i>)	returns MSG(Sii, Sji, Sij, Sjj)
mu1(complex a , complex b , complex c , complex d)	$\mu\text{-factor} = (1 - \text{abs}(\mathbf{a})^2) / (\text{abs}(\mathbf{d} - \text{conj}(\mathbf{a}) \times (\mathbf{a} \times \mathbf{d} - \mathbf{b} \times \mathbf{c})) + \text{abs}(\mathbf{b} \times \mathbf{c}))$
mu1(scalar <i>i</i> , scalar <i>j</i>)	returns mu1(Sii, Sji, Sij, Sjj)
mu2(complex a , complex b , complex c , complex d)	$\mu\text{-factor} = (1 - \text{abs}(\mathbf{d})^2) / (\text{abs}(\mathbf{a} - \text{conj}(\mathbf{d}) \times (\mathbf{a} \times \mathbf{d} - \mathbf{b} \times \mathbf{c})) + \text{abs}(\mathbf{b} \times \mathbf{c}))$
mu2(scalar <i>i</i> , scalar <i>j</i>)	returns mu2(Sii, Sji, Sij, Sjj)
T11(complex a , complex b , complex c , complex d)	$T_{11} \text{ conversion} = -(\mathbf{a} \times \mathbf{d} - \mathbf{b} \times \mathbf{c})/\mathbf{b}$
T11(scalar <i>i</i> , scalar <i>j</i>)	returns T11(Sii, Sji, Sij, Sjj)
T12(complex a , complex b , complex c , complex d)	$T_{12} \text{ conversion} = \mathbf{a}/\mathbf{b}$
T12(scalar <i>i</i> , scalar <i>j</i>)	returns T12(Sii, Sji, Sij, Sjj)
T21(complex a , complex b , complex c , complex d)	$T_{21} \text{ conversion} = -\mathbf{d}/\mathbf{b}$
T21(scalar <i>i</i> , scalar <i>j</i>)	returns T21(Sii, Sji, Sij, Sjj)
T22(complex a , complex b , complex c , complex d)	$T_{22} \text{ conversion} = 1/\mathbf{b}$
T22(scalar <i>i</i> , scalar <i>j</i>)	returns T22(Sii, Sji, Sij, Sjj)
Y11(complex a , complex b , complex c , complex d)	$Y_{11} \text{ conversion} = (1/Z_0) \times ((1-\mathbf{a}) \times (1+\mathbf{d}) + \mathbf{b} \times \mathbf{c}) / ((1+\mathbf{a}) \times (1+\mathbf{d}) - \mathbf{b} \times \mathbf{c})$
Y11(scalar <i>i</i> , scalar <i>j</i>)	returns Y11(Sii, Sji, Sij, Sjj)
Y12(complex a , complex b , complex c , complex d)	$Y_{12} \text{ conversion} = (1/Z_0) \times (-2 \times \mathbf{c}) / ((1+\mathbf{a}) \times (1+\mathbf{d}) - \mathbf{b} \times \mathbf{c})$
Y12(scalar <i>i</i> , scalar <i>j</i>)	returns Y12(Sii, Sji, Sij, Sjj)
Y21(complex a , complex b ,	$Y_{21} \text{ conversion} = (1/Z_0) \times (-$

complex c , complex d)	$2 \times b / ((1+a) \times (1+d) - b \times c)$
Y21(scalar i, scalar j)	returns Y21(Sii, Sji, Sij, Sjj)
Y22(complex a , complex b , complex c , complex d)	$Y_{22} \text{ conversion} = (1/Z_0) \times ((1+a) \times (1-d) + b \times c) / ((1+a) \times (1+d) - b \times c)$
Y22(scalar i, scalar j)	returns Y22(Sii, Sji, Sij, Sjj)
Z11(complex a , complex b , complex c , complex d)	$Z_{11} \text{ conversion} = Z_0 \times ((1+a) \times (1-d) + b \times c) / ((1-a) \times (1-d) - b \times c)$
Z11(scalar i, scalar j)	returns Z11(Sii, Sji, Sij, Sjj)
Z12(complex a , complex b , complex c , complex d)	$Z_{12} \text{ conversion} = Z_0 \times (2 \times c) / ((1-a) \times (1-d) - b \times c)$
Z12(scalar i, scalar j)	returns Z12(Sii, Sji, Sij, Sjj)
Z21(complex a , complex b , complex c , complex d)	$Z_{21} \text{ conversion} = Z_0 \times (2 \times b) / ((1-a) \times (1-d) - b \times c)$
Z21(scalar i, scalar j)	returns Z21(Sii, Sji, Sij, Sjj)
Z22(complex a , complex b , complex c , complex d)	$Z_{22} \text{ conversion} = Z_0 \times ((1-a) \times (1+d) + b \times c) / ((1-a) \times (1-d) - b \times c)$
Z22(scalar i, scalar j)	returns Z22(Sii, Sji, Sij, Sjj)

NOTE

For both mu1 and mu2, conj is the complex conjugate. For scalars a and b, conj(a+ib)=(a-ib).

Channel Parameter Data	
data	corrected data
data(scalar i)	corrected data of trace i (trace number)
mem	memory data
mem(scalar i)	memory data of trace i (trace number)
xAxis	x-axis data
xAxis(scalar i)	x-axis data of trace i (trace number)

S11 - S22	S-parameter data
-----------	------------------

NOTE

When a trace number is out of range, the E5061B indicates an error message, "Equation runtime error" and equation is not reflected on the trace. The maximum number of traces can be set by **System > Misc Setup > Channel/Trace Setup**.

Converting S-Parameters to H, Y, Z, F & T-Parameters

The following section provides definition of the two port parameters in Equation Editor.

1. Hybrid parameters (H)

$$\begin{pmatrix} V_1 \\ I_2 \end{pmatrix} = (H) \begin{pmatrix} I_1 \\ V_2 \end{pmatrix} \quad (H) = \begin{pmatrix} H_{11} & H_{12} \\ H_{21} & H_{22} \end{pmatrix}$$

2. Admittance parameters (Y)

$$\begin{pmatrix} I_1 \\ I_2 \end{pmatrix} = (Y) \begin{pmatrix} V_1 \\ V_2 \end{pmatrix} \quad (Y) = \begin{pmatrix} Y_{11} & Y_{12} \\ Y_{21} & Y_{22} \end{pmatrix}$$

3. Impedance parameters (Z)

$$\begin{pmatrix} V_1 \\ V_2 \end{pmatrix} = (Z) \begin{pmatrix} I_1 \\ I_2 \end{pmatrix} \quad (Z) = \begin{pmatrix} Z_{11} & Z_{12} \\ Z_{21} & Z_{22} \end{pmatrix}$$

Fundamental parameters (F)

$$\begin{pmatrix} V_1 \\ I_1 \end{pmatrix} = (F) \begin{pmatrix} V_2 \\ -I_2 \end{pmatrix} \quad (F) = \begin{pmatrix} A & B \\ C & D \end{pmatrix}$$

4.

$$\begin{pmatrix} b_1 \\ b_2 \end{pmatrix} = (S) \begin{pmatrix} a_1 \\ a_2 \end{pmatrix} \quad (S) = \begin{pmatrix} S_{11} & S_{12} \\ S_{21} & S_{22} \end{pmatrix}$$

$$a_1 = \frac{V_1 + I_1 Z_0}{2 \cdot \sqrt{Z_0}} \quad a_2 = \frac{V_2 + I_2 Z_0}{2 \cdot \sqrt{Z_0}}$$

$$b_1 = \frac{V_1 - I_1 Z_0}{2 \cdot \sqrt{Z_0}} \quad b_2 = \frac{V_2 - I_2 Z_0}{2 \cdot \sqrt{Z_0}}$$

5. Scattering transfer parameters (T)

$$\begin{pmatrix} b_1 \\ a_1 \end{pmatrix} = (T) \begin{pmatrix} a_2 \\ b_2 \end{pmatrix} \quad (T) = \begin{pmatrix} T_{11} & T_{12} \\ T_{21} & T_{22} \end{pmatrix}$$

S-parameters of 2-port network can be converted to Hybrid parameters (H), Admittance parameters (Y), Impedance parameters (Z), Fundamental parameters (F) and Scattering transfer parameters (T) using the following functions:

1. Converting S-parameters to H-parameters

$$H_{11} = Z_0 \cdot \frac{(1 + S_{11})(1 + S_{22}) - S_{12}S_{21}}{(1 - S_{11})(1 + S_{22}) + S_{12}S_{21}}$$

$$H_{12} = \frac{2 \cdot S_{12}}{(1 - S_{11})(1 + S_{22}) + S_{12}S_{21}}$$

$$H_{21} = \frac{-2 \cdot S_{21}}{(1 - S_{11})(1 + S_{22}) + S_{12}S_{21}}$$

$$H_{22} = \frac{1}{Z_0} \cdot \frac{(1 - S_{11})(1 - S_{22}) - S_{12}S_{21}}{(1 - S_{11})(1 + S_{22}) + S_{12}S_{21}}$$

2. Converting S-parameters to Y-parameters

$$Y_{11} = \frac{1}{Z_0} \cdot \frac{(1 - S_{11})(1 + S_{22}) + S_{12}S_{21}}{(1 + S_{11})(1 + S_{22}) - S_{12}S_{21}}$$

$$Y_{12} = \frac{1}{Z_0} \cdot \frac{-2 \cdot S_{12}}{(1 + S_{11})(1 + S_{22}) - S_{12}S_{21}}$$

$$Y_{21} = \frac{1}{Z_0} \cdot \frac{-2 \cdot S_{21}}{(1 + S_{11})(1 + S_{22}) - S_{12}S_{21}}$$

$$Y_{22} = \frac{1}{Z_0} \cdot \frac{(1 + S_{11})(1 - S_{22}) + S_{12}S_{21}}{(1 + S_{11})(1 + S_{22}) - S_{12}S_{21}}$$

3. Converting S-parameters to Z-parameters

$$Z_{11} = Z_0 \cdot \frac{(1 + S_{11})(1 - S_{22}) + S_{12}S_{21}}{(1 - S_{11})(1 - S_{22}) - S_{12}S_{21}}$$

$$Z_{12} = Z_0 \cdot \frac{2 \cdot S_{12}}{(1 - S_{11})(1 - S_{22}) - S_{12}S_{21}}$$

$$Z_{21} = Z_0 \cdot \frac{2 \cdot S_{21}}{(1 - S_{11})(1 - S_{22}) - S_{12}S_{21}}$$

$$Z_{22} = Z_0 \cdot \frac{(1 - S_{11})(1 + S_{22}) + S_{12}S_{21}}{(1 - S_{11})(1 - S_{22}) - S_{12}S_{21}}$$

4. Converting S-parameters to F-parameters

$$A = \frac{(1 + S_{11})(1 - S_{22}) + S_{12}S_{21}}{2 \cdot S_{21}}$$

$$B = Z_0 \cdot \frac{(1 + S_{11})(1 + S_{22}) - S_{12}S_{21}}{2 \cdot S_{21}}$$

$$C = \frac{1}{Z_0} \cdot \frac{(1 - S_{11})(1 - S_{22}) - S_{12}S_{21}}{2 \cdot S_{21}}$$

$$D = \frac{(1 - S_{11})(1 + S_{22}) + S_{12}S_{21}}{2 \cdot S_{21}}$$

5. Converting S-parameters to T-parameters

$$T_{11} = \frac{-D_s}{S_{21}}$$

$$T_{12} = \frac{S_{11}}{S_{21}}$$

$$T_{21} = \frac{-S_{22}}{S_{21}}$$

$$T_{22} = \frac{1}{S_{21}}$$

Where:

$$D_s = S_{11}S_{22} - S_{12}S_{21}$$

Operators used in Equation Editor

Operator	Description
+	Addition
-	Subtraction
*	Multiplication
/	Division
^	Power
(Open parenthesis
)	Close parenthesis
,	Comma - separator for arguments
=	Equal (optional)
E	Exponent (as in 23.45E6)

NOTE

Priority of operators is:

1. ^
2. *, /
3. +, -

Outputting Data

Outputting Data

- Saving and Recalling Instrument State
- Saving/Recalling Instrument State for Each Channel into/from Memory
- Compatibility of State File
- Saving Trace Data to a File
- Saving the Screen Image to a File
- Printing Displayed Screen

Saving and Recalling Instrument State

- [Overview](#)
- Saving Data
- Recall Procedure
- Recall Procedure Using "Recall by File Name"
- Priority of Recalling Configuration File at Startup

Other topics about Data Output

Overview

You can save the instrument state of the E5061B into a file on mass storage and then recall it later to reproduce that state. You can select the stored data from the following four types.

Type	Stored data and usage
State only (State Only)	Saves the setting of the E5061B and reproduces the state when it is saved by recalling it later into the E5061B.
State and calibration data (State & Cal)	Saves the setting of the E5061B and calibration data (calibration coefficient array) to reproduce the state when it was saved by recalling it later into the E5061B. At this time, you can perform error correction of measured values by using the recalled calibration data.
State and trace (State & Trace)	Saves the setting of the E5061B and traces (error-corrected data array and error-corrected memory array) to reproduce the state when it was saved by recalling it later into the E5061B. At this time, the traces are also recalled and displayed on the screen.
State, calibration data, and traces (All)	Saves the setting of the E5061B, calibration data, and traces to reproduce the state when it was saved by recalling it later into the E5061B. At this time, the calibration data and traces are also recalled.

In addition, the user-preset function is provided to allow the user to freely set up an instrument state recalled when the preset function is executed.

Saving Data

[Selecting Content to be Saved](#)

NOTE

This setting takes effect both, when saving the entire instrument state into a file and when saving the instrument state for each channel into memory.

1. Press **Save/Recall** > **Save Type**.
2. Click the softkey corresponding to the content of the instrument state you want to save.

Selecting Save Target Channel/Trace

1. Press **Save/Recall** key.
2. Click **Channel/Trace** and select the save target from all channels/traces (**All**) or displayed channel/traces only (**Disp Only**).

If you specify the displayed channel/traces only as the save target, you can reduce the file size. However, for channels/traces that are not displayed, you cannot recall and reproduce the instrument state separately held for each channel/trace at a later time.

Saving Instrument State

Follow the procedure below to save internal data from the E5061B.

1. Press **Save/Recall** > **Save State**.
2. Click the softkey corresponding to the destination you want to save.

Softkey	Description
State01 to State08	Save the instrument state into the state number.
Autorec	<p>Save the instrument state as the auto recall setting. The E5061B is automatically configured with this state at the startup.</p> <p>This key saves the state into the "D:Autorec.sta".</p> <p>When Autorec.sta file is found on the D: drive at startup, the E5061B is automatically configured using the saved settings. To disable the auto recall function, delete the Autorec.sta files.</p>
User Pres	Save the instrument state as user preset. The user can preset the analyzer at user saved status.
File Dialog...	Save the instrument state as your desired file name. You can enter a file name using the Input from the front panel buttons on the dialog box when storing a file.

NOTE

If **D:\Autorec.sta** is found on the system at startup, the E5061B is automatically configured using the saved settings. When the external floppy disk drive is connected as A: drive, then if **A:\Autorec.sta** is found at startup, the E5061B is also automatically configured using the saved settings. If both files are found, **A:\Autorec.sta** is recalled. To disable the auto recall function, delete the **Autorec.sta** files.

NOTE

An asterisk (*) in the upper right of the softkey indicates that the corresponding file of the softkey already exists. If you save into the existing file, the existing file is copied as **backup.sta** and then overwritten.

Recall Procedure

Follow the procedure below to recall internal data from the E5061B.

NOTE

If you recall a file that includes traces (its content was set to **State & Trace** or **All** when it was saved), the trigger source is automatically set to Manual.

1. Press **Save/Recall** > **Recall State**.

When you want to recall *State01.sta - State08.sta, Autorec.sta*

1. Press **State01** - **State08** or **Autorec**.

When you want to recall other files

1. Press **File Dialog...** to open the Open dialog box.
2. Select the folder and the file using the external keyboard and mouse.
3. Click **Open**.

The warning messages may appear when recall fails:

NOTE

When a user file is used in Extending the Calibration Plane Using Network De-embedding, Determining Characteristics After Adding a Matching Circuit, or Determining the Characteristics that Result from Adding a Matching Circuit to a Differential Port and the setup status is saved, a recall error occurs if the user file is not located in the same folder as when the state is saved.

NOTE

Pressing **Save/Recall** > **Explorer** executes Windows Explorer. This helps you to browse the files in the ENA hard disk drive.

Recall Procedure Using "Recall by File Name" Feature

You can use the recall feature with the **Recall by File Name** softkey for files you have named freely and save in the **D:\State** folder. This function lets you recall a file you have named freely and save by simple softkey operation, eliminating annoying operation using the Open dialog box.

NOTE

Although there is no limit to the number of files saved in a folder, only up to 50 files are displayed on the softkeys. If more than 50 files are saved in a folder, they are sorted in the order of numbers 0 to 9 and alphabetic characters A to Z and the first 50 files are displayed as softkeys.

Although there is no limit to the number of characters of a file name, only up to 12 characters are displayed on the softkey. If a file name exceeds 12 characters, the first 12 characters are displayed on the softkey and the remaining characters are omitted and replaced with "...".

NOTE

Different files may be displayed on softkeys with the same name or a saved file is not displayed on any softkey because of the above limitations.

1. Press **Save/Recall** > **Recall by File Name**.
2. Files that have been named and saved in the **D:\State** folder are displayed on softkeys. Press the key for the file you want to recall.

Priority of Recalling Configuration File at Startup

If several instrument configuration files exist at the startup of the E5061B, only one file is recalled and set at a time in the following order of priority.

If these files do not exist, the normal preset (factory preset) is executed.

Priority	Recalled file
1	Configuration file for the auto-recall function in the A drive (If external floppy disk drive is connected.)
2	Configuration file for the auto-recall function in the D drive
3	Configuration file for the user-preset function in the D drive. Executed when the preset operation mode is User and the file (D:\UserPreset.sta) exists.

Saving/Recalling Instrument State for Each Channel into/from Memory

- [Overview](#)
- Saving Instrument State for Each Channel
- Recalling Instrument State for Each Channel
- Deleting Saved Instrument State (Clearing all Registers)

Other topics about Data Output

Overview

The E5061B allows you to save/recall the instrument state for each channel independently. This function allows you to save the instrument state of the active channel independently into one of the four registers (A to D, volatile memory) and to recall the instrument state from the register to restore it as the state of the currently active channel. As in the case of saving the entire state of the instrument into a file, you can select items to be saved from four kinds.

Since you can recall the instrument state for each channel that was saved with this function from a different channel than the one used to save it, this function is very useful for copying an instrument state between channels.

NOTE

Unlike when saving the entire instrument state, the instrument state for each channel is saved into volatile memory instead of a file, so if you turn off the power, this state is lost.

Saving Instrument State for Each Channel

1. Press **Channel Next** (or **Channel Prev**) to activate a channel of which the state you want to save.
2. Press **Save/Recall** > **Save Channel**.
3. Click one of **State & Cal A to D**, **Cal Only A to D** to save the (instrument state and) calibration data of the active channel to the specified register.

NOTE

For registers having saved data, the * symbol is displayed to the right of their softkey label. If you specify one of these, its content is overwritten.

Recalling Instrument State for Each Channel

1. Press **Channel Next** (or **Channel Prev**) to activate a channel of which the state you want to recall and restore.
2. Press **Save/Recall** > **Recall Channel**.

3. Click the softkey of the register in which the state you want to restore is saved. This instrument state is recalled to the active channel.

Deleting Saved Instrument State (Clearing all Registers)

1. Press **Save/Recall** > **Save Channel**.
2. Click **Clear States**. The contents of all the registers are deleted.

Compatibility of State File

- [Overview](#)
- [Compatibility of Files \(Saving and Recalling\)](#)
- [State File Converter](#)

Other topics about Data Output

Overview

As mentioned in Saving and Recalling Instrument State, you can save the instrument state of the E5061B into a file on the mass storage and then recall it later to reproduce that state.

Alternatively, you can use the state file saved in E5061A and E5062A in a similar way.

Compatibility of Files (Saving and Recalling)

Compatibility from [E5061A/E5062A and other ENA series products](#)

State files from E5061A/E5062A can be converted to E5061B compatible state file. This can be performed by using the State File Converter Software. However, there is no compatibility of state files between E5061B and other ENA series products.

Files saved with the E5061A, E5062A and the other ENA series products cannot be recalled with the E5061B. Similarly, files saved with the E5061B cannot be recalled with the E5061A and E5062A.

Compatibility between different options

- The files saved with the E5061B without Time domain/Fault Location option can be recalled in the E5061B with Time domain/Fault Location option. The files saved with the E5061B with Time domain/Fault Location option can be recalled with the E5061B without Time domain/Fault Location option. The settings for Fault Location/Gating/SRL are not used.
- The files saved with the E5061B without Impedance Measurement option can be recalled in the E5061B with Impedance Measurement option. The files saved with the E5061B with Impedance Measurement option can be recalled with the E5061B without Impedance Measurement option.

Compatibility between different frequency models

		Recalling by E5061B									
	Op t.	3L 5	2 3	2 1	1 3	1 1	2 3	2 1	1 3	1 1	

Save d file by E506 1B	No		5	5	5	5	7	7	7	7
	3L 5	Y	N	N	N	N	N	N	N	N
	23 5	Y	Y	N	N	N	N	N	N	N
	21 5	Y	Y	Y	N	N	N	N	N	N
	13 5	Y	Y	N	Y	N	N	N	N	N
	11 5	Y	Y	Y	Y	Y	N	N	N	N
	23 7	N	N	N	N	N	Y	N	N	N
	21 7	N	N	N	N	N	Y	Y	N	N
	13 7	N	N	N	N	N	Y	N	Y	N
	11 7	N	N	N	N	N	Y	Y	Y	Y

Y: Recall is possible, N: Recall is not possible.

Compatibility when the Firmware revision is different

- Files that are saved with later firmware revisions may not be recalled by prior firmware revisions.

Compatibility when the system spec. version (available with ":SERV:SREV?") is different

- When files that are saved with different system spec. versions include calibration data, only states and trace data are recalled.

NOTE

If you recall an incompatible file, an error occurs and the device recovers to the default setting.

State File Converter

The State File Converter software converts the state files from E5061A/E5062A to E5061B compatible state file.

Most state file settings from E5061A/E5062A can be converted to be used in E5061B except:

- **User calibration data**

User calibration data cannot be converted by the State File Converter. Even if the E5061A/62A state file has calibration data, the calibration data is ignored and is not converted.

- **Multiport test set settings**

Multiport test set settings are not converted. This is because unlike E5061A/62A, the E5061B does not support multiport test sets. Hence, the below settings are not converted:

- : SENSE [1-4]: CORRection: MULTiport: COLLEct: METHod
- : SENSE [1-4]: CORRection: MULTiport: SELF [: STATe]
- : SENSE [1-4]: CORRection: MULTiport: SELF: TIMer
- : SENSE [1-4]: CORRection: MULTiport [: STATe]
- : SENSE [1-4]: MULTiport: PORT [1-2]: SELEct
- : SENSE [1-4]: MULTiport: PROPerTy
- : SENSE [1-4]: MULTiport [: STATe]

Executing State File Converter (UI)

The State File Converter is located in the E5061B at D:\Agilent\E5061A_StateFileConverter.vba. This vba software is a sort of user interface and it calls the main program named "StateFileConverter.exe" shown below.

To execute this converter file:

1. Press **Macro Setup** button.
2. Click **Load Project...** from the **Macro Setup** menu.
3. Select D:\Agilent\E5061A_StateFileConverter.vba file and click **Open**.
4. Click **Select Macro** from the **Macro Setup** menu and select **Module1 main** option.
5. The E5061A/62A State File Converter shows.

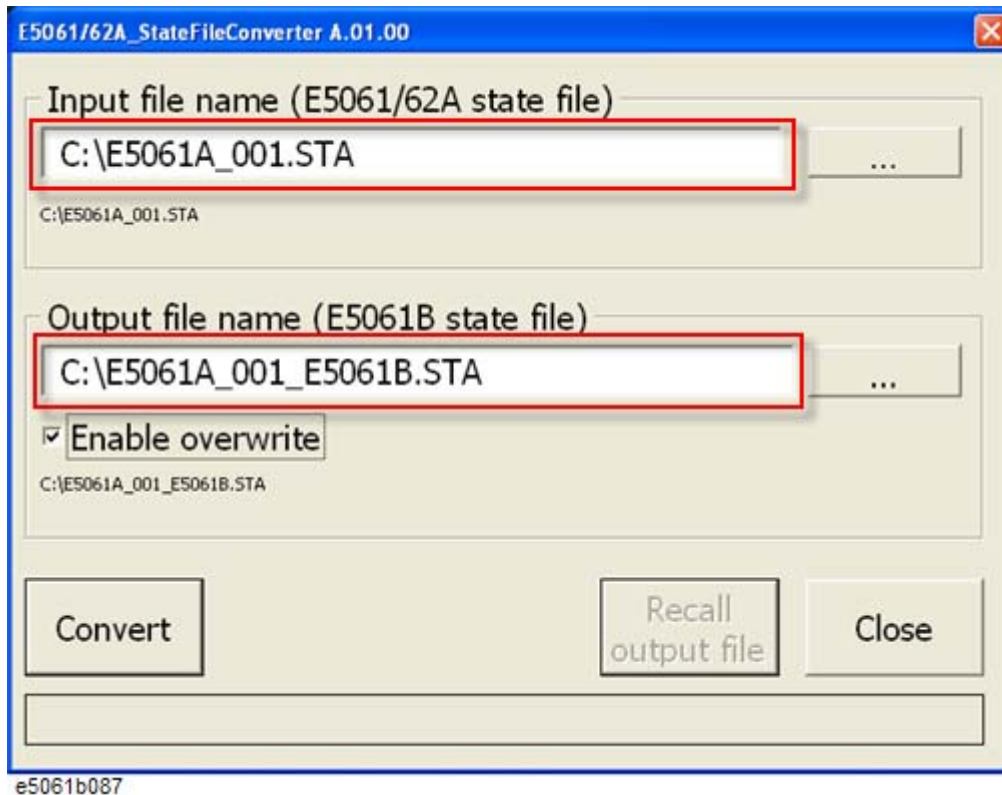

6. At **Input file name (E5061A/62A state file)**, select the state file from E5061A or E5062A that you want to convert.
7. At **Output file name (E5061B state file)**, enter the name of the new state file or select an existing state file to be overwritten.
8. Once both input and output file names are selected, the **Convert** button is activated.
9. Click **Convert** to execute the conversion.
10. Once the conversion process is completed, the **Recall output file** button is activated.
11. Click **Recall output file** to recall the output file. This is a shortcut method to recall the output file instead of **Save/Recall > Recall State > File Dialog**.

Executing State File Converter (.exe)

The executable file of the State File Converter is located in the E5061B at C:\Program

E5061B

Files\Agilent\E5061B\StateFileConverter\StateFileConverter.exe. To execute this converter file using command prompt:

1. Go to **Command Prompt**.
2. Go to C:\Program Files\Agilent\E5061B\StateFileConverter location.
3. Type **StateFileConverter.exe -i:<input.sta> -o:<output.sta>**.

Mandatory Option

-I:<input file path> (E5061/62A state file)

-O:<output file path> (E5061B state file)

No space after the colon

Return code

0: no error

1: no error (cal data discarded)

10: read file error

20: write file error

NOTE

StateFileConverter.exe should be executed from the original directory as it calls for other files to run successfully.

You can create the batch file as shown below.

Convert.bat

```
@echo off
if not exist E5061B mkdir E5061B
for %%i in (*.sta) do (
echo Converting %%~fi
"C:\Program Files\Agilent\E5061B\StateFileConverter\StateFileConverter.exe" -i:"%%~fi" -
o:"%~dp0E5061B\%%~nxi"
if errorlevel 20 (
echo Write File Error
) else if errorlevel 10 (
echo Read File Error
) else if errorlevel 1 (
```

```

echo   Convert Success without Cal Data
) else if errorlevel 0 (
echo   Convert Success
)
)

```

How to execute the batch file

The batch file allows you to convert multiple state files at once.

To execute the batch file:

1. Place convert.bat and all the state files in the same folder.
2. Go to **Command Prompt**.
3. Go to the location where convert.bat and state files are stored.
4. Type **convert.bat**.
5. A sub-folder named E5061B is created automatically where all the converted state files are placed.

State File Converter Messages

Below are the messages that may prompt during state file conversion:

- **"Converting..."**
- **"Conversion done"**
- **"Conversion done (CAL data discarded)"**

Conversion is successfully completed and the original CAL data is deleted.

- "Input file does not exist"
- "Output file does not exist"
- "Output file name is an existing folder"
- "Input file error"

The system cannot understand the file path as the folder or file name is in Asian characters (fonts), or the file is not a state file created by E5061A/62A.

- "Output file error"

The system cannot understand the file path as the folder or file name is in Asian characters (fonts).

- **"Input file name and output file name are the same"**

Saving Trace Data to a File

- [Saving Data in CSV Format](#)
- [Saving Data in Touchstone Format](#)

Other topics about Data Output

Saving Data in CSV Format

The E5061B allows the user to save data for the active trace on the active channel to a CSV file (file extension *.csv) and to load the data into PC application software for further processing.

Trace data are saved in the format shown below.

Example of saved trace data

```
"# Channel 1"
"# Trace 1"
Frequency,          Formatted Data,      Formatted Data
+3.00000000000E+005, +1.41837599227E-002, +1.43446459328E-006
+4.27985000000E+007, +1.41275293412E-002, +2.02407834551E-004
+8.52970000000E+007, +1.41334093048E-002, +4.00643331604E-004
+1.27795500000E+008, +1.41240661092E-002, +6.09250514670E-004
+1.70294000000E+008, +1.41402155348E-002, +8.05620003993E-004
```

The first line shows the number of the active channel at the time the data is saved.

The second line shows the number of the active trace at the time the data is saved.

The third line is a header line indicating the contents of each item of trace data written on the fourth line onward.

The fourth line onward shows the trace data. The amount of data is determined by the number of points (frequency) assigned to the trace.

Saving Trace Data

Follow the procedure below to save trace data from the E5061B.

1. Press **Channel Next** (or **Channel Prev**) and **Trace Next** (or **Trace prev**) to select the trace to be saved.
2. Press **Save/Recall** > **Save Trace Data** to open the Save As dialog box.
3. Select the destination folder and input a file name.
4. Click **Save** to save the file.

NOTE

This function is inactive when the security level is set at low/high.

Saving Data in Touchstone Format

You can also save trace data of a E5061B active channel of S-parameter to a Touchstone format file.

Touchstone file data format

You can save data in "log magnitude - angle", "linear magnitude - angle", or "real number - imaginary number."

When AUTO is selected, the data format is automatically set according to the display format of the active trace. However, when the display format of the active trace is set to one other than the log magnitude format (LogMag), linear magnitude format (LinMag), or real-imaginary number format (Real/Imag), the data format is automatically set to real-imaginary number.

You can use data saved in Touchstone format for a circuit simulator such as Agilent Advanced Design System (ADS) on your PC (personal computer) or workstation. For more information on the ADS, refer to the operation manual that comes with the system.

File types of Touchstone files

File types of the E5061B Touchstone files are s1p and s2p. The file type indicates the number of ports of the data structure that is output to the Touchstone file.

Data structure in Touchstone file

Data structure of the Touchstone file consists of a header part and a data part. The contents of the file is text data, which is ready to be read with a general text editor.

The header part consists of the returned value of *IDN?, file created date, calibration state, list of all S parameters of a specified port, and format information.

The header parts of s1p and s2p are shown below.

Header of s1p

```
!Agilent Technologies,E5061B,<ID>,<FW Revision>
!Date <Date>
!Data & Calibration Information
!Freq Syy:Method(Stat)
# Hz S FMT R Z0
```

Header of s2p

```
!Agilent Technologies,E5061B,<ID>,<FW Revision>
!Date <Date>
!Data & Calibration Information
!Freq Syy:Method(Stat) Syz:Method(Stat) Szy:Method(Stat) Szz:Method(Stat)
# Hz S FMT R Z0
```

Each item has the following meaning:

Parameter	Description
Syy to Szz	S parameters of the selected test port; corresponds in ascending order, beginning with y to z.
Method	Calibration type applied to S parameter.
Stat	State of S parameter calibration and error correction setting (ON, OFF, or --) ON = Error correction is set to ON OFF = Error correction is set to OFF -- = Calibration is not performed
FMT	Data format RI = Real number - imaginary number MA = Linear magnitude - angle DB = Log magnitude - angle
Z0	Reference impedance value

The structure of the data part depends on the combination of the selected file type and specified port.

NOTE

When the S parameter of a port on which calibration is not performed is specified, if the data measured with the S parameter exists, that data are output to a Touchstone file. If no measurement data exists, 0 (for log magnitude - angle, log magnitude = -200 dB) is output in the corresponding field.

The following figures show the data structures of files saved in Touchstone format.

1-port Touchstone file

```
Data
Freq (1) Tab Saa, pri (1) Tab Saa, sec (1) ↵
Freq (2) Tab Saa, pri (2) Tab Saa, sec (2) ↵
      ⋮
Freq (N) Tab Saa, pri (N) Tab Saa, sec (N) ↵
```

a : Selected test port number
 Freq(n) : Frequency at measurement point n [Hz]
 Saa, pri(n) : Real part(RI), linear magnitude(MA) or dB(DB) of measured parameter Saa at measurement point n
 Saa, sec(n) : Imaginary part(RI) or phase(MA, DB) of measured parameter Saa at measurement point n
 N : Number of measurement points
 Tab : Tab
 ↵ : Line break

e5071c346

2-port Touchstone file

```

Freq (1) Tab Saa, pri (1) Tab Saa, sec (1) Tab Sba, pri (1) Tab Sba, sec (1) Tab Sbb, pri (1) Tab Sbb, sec (1) ↵
Freq (2) Tab Saa, pri (2) Tab Saa, sec (2) Tab Sba, pri (2) Tab Sba, sec (2) Tab Sbb, pri (2) Tab Sbb, sec (2) ↵
      ⋮
Freq (N) Tab Saa, pri (N) Tab Saa, sec (N) Tab Sba, pri (N) Tab Sba, sec (N) Tab Sbb, pri (N) Tab Sbb, sec (N) ↵
```

Data

a - b : Selected test port number (corresponding in ascending order, beginning with 1 to a)
 Freq(n) : Frequency at measurement point n [Hz]
 Sxy, pri(n) : Real part(RI), linear magnitude(MA) or dB(DB) of measured parameter Sxy at measurement point n
 Sxy, sec(n) : Imaginary part(RI) or phase(MA, DB) of measured parameter Sxy at measurement point n
 N : Number of measurement points
 Tab : Tab
 ↵ : Line break

e5071c347

Restrictions when saving data in Touchstone format

The following restrictions apply in saving measurement data into Touchstone format.

- When both fixture simulation and port impedance conversion are ON, all Z0 of the ports to be saved must be set to the same value. If Z0 is different among the ports, no error occurs, but only the Z0 of the smallest port number is output to the header.
- When the time domain function is ON, the saved data are not the displayed data but the data of the S parameter before conversion.
- For data saved in touchstone format, data operation, time domain, parameter conversion, data format, electrical delay, equation editor, and smoothing are not reflected in the output data.

[Saving procedure](#)

Follow the steps below to save trace data in Touchstone format.

1. Press **Channel Next** (or **Channel Prev**) and **Trace Next** (or **Trace prev**) to select the trace to be saved.
2. Press **Save/Recall** > **SnP** > **SnP Format**.
3. Click the softkey that corresponds to the data format you want to save.

Softkey	Function
Auto	Data format is automatically set according to the display format of the active trace. When the display format of the active trace is set to one other than log magnitude format (LogMag), linear magnitude format (LinMag), or real-imaginary number format (Real/Imag), the data format is automatically set to real-imaginary number.
LogMag/Angle	Select "log magnitude - angle" data format
LinMag/Angle	Select "linear magnitude - angle" data format
Real/Imaginary	Select "real - imaginary number" data format

5. Click the softkey for **s1p** or **s2p** according to the file type you want to save.
6. Click the softkey that corresponds to the combination of ports that you want to save.
7. SaveAs dialog box opens. For its operations, use an external keyboard and mouse.
8. Specify the folder to which the file should be saved, enter a file name, and then press **Save** to save the file.

NOTE

When saving data in a sweep process, the data during sweep is saved into a Touchstone file. That is, the previous sweep data is saved as data that has not been swept; or, if sweep was not performed previously, zero data might be saved. Therefore, you should set the active channel to the HOLD state when saving data into a Touchstone file.

NOTE

This function is inactive when the security level is set at low/high.

Saving the Screen Image to a File

- [Overview](#)
- Saving Screen Image as File

Other topics about Data Output

Overview

Along with printing, the E5061B allows the user to save screen images as bitmap (.bmp) or portable network graphics (.png) files. Saved files can be loaded into PC application software for further processing.

Saving Screen Image as File

Follow the procedure below to save a screen image to a file.

1. Display the screen to be saved as a file. If you want to save the screen with a white background, set the display mode to inverted display before saving the screen. For details about display mode, see Setting Display Colors.
2. Press **System** key. The screen image at the time **System** key is pressed is the image that will be saved.
3. Press **Dump Screen Image** to open the Save As dialog box.
4. Select the file type from "24-Bit Bitmap (*.bmp)" or "Portable Network Graphics (*.png)".
5. Select the destination folder and type a file name. (Clicking **Input from the front panel** on the Save As dialog box activates the on screen keyboard.)
6. Press **Save** to save the screen image of E5061B to a file.

Printing Displayed Screen

- [Overview](#)
- Printed/Saved Images
- Print Procedure

Other topics about Data Output

Overview

By connecting a printer to the USB port of the E5061B, you can print the displayed screen of the E5061B.

Printed/Saved Images

The display image saved in the volatile memory (clipboard) is printed/saved. If no image is saved in the clipboard, the image displayed at the time of print execution is printed/saved.

Saving image to clipboard

The **System** key also has a screen capture feature. When you press **System** key, the image displayed on the screen immediately before pressing is saved in the clipboard.

NOTE

The image in the clipboard is cleared when you execute print/save.

Print Procedure

Preparation before printing

Follow these steps to prepare for printing:

1. Turns OFF the E5061B.
2. Turn ON the printer and connect it to E5061B.
3. Turn ON the E5061B.
4. Press **System** key.
5. Press **Printer Setup**. The Printers window opens. The icons of the printers that have been connected are displayed in the window. When you connect a print for the first time, it is automatically registered and its icon is added in the window.
6. The printer with the check mark (☑) on its icon is selected as the default printer for printing. If you want to change it, select (highlight) the icon of your preferred printer in the Printers window and then click **Set as Default Printer** in the File menu.
7. Click **Printing Preferences...** in the File menu. The Printing Preferences dialog box for the selected printer appears. Set items necessary before printing such as Page Size and then click the **OK** button .

8. Click **Close** in the File menu.

Executing print

Follow these steps to print the screen information:

1. Display the screen you want to print.
2. Press **System** key to save the currently displayed screen onto the clipboard.
3. As necessary, press **Invert Image** to toggle between [OFF] for printing in colors close to the actually displayed screen and [ON] for printing in inverse colors.
4. Click **Print** to start printing.
5. To cancel the printing in progress, press **Abort Printing**.

NOTE

If you start printing when the printer is not ready (for example, it is not turned ON) by mistake, the Printers Folder dialog box may appear. In this case, click Cancel to close the Printers Folder dialog box, prepare your printer, and then start printing again.

Optimizing Measurements

Optimizing Measurements

- Expanding Dynamic Range
- Reducing Trace Noise
- Improving Phase Measurement Accuracy
- Improving Measurement Throughput

Expanding Dynamic Range

- [Overview](#)
- Lowering Receiver Noise Floor

Other topics about Optimizing Measurement

Overview

The dynamic range is the finite difference between the maximum input power level and the minimum measurement power level (noise floor) of the analyzer. In evaluating a characteristic accompanied by a large change in the amplitude (the pass band and stop band of a filter, for example), it is important to increase the dynamic range.

Lowering Receiver Noise Floor

Lowering the noise floor of the receiver enables you to expand the dynamic range. The following methods can be used to lower the receiver noise floor.

- Narrowing the IF bandwidth
- Turning on Sweep Averaging

Narrowing the IF bandwidth

Narrowing the receiver IF bandwidth enables you to reduce the effect of random noise on measurements. Narrowing the IF bandwidth to 1/10 the original bandwidth causes the receiver noise floor to decrease by 10 dB.

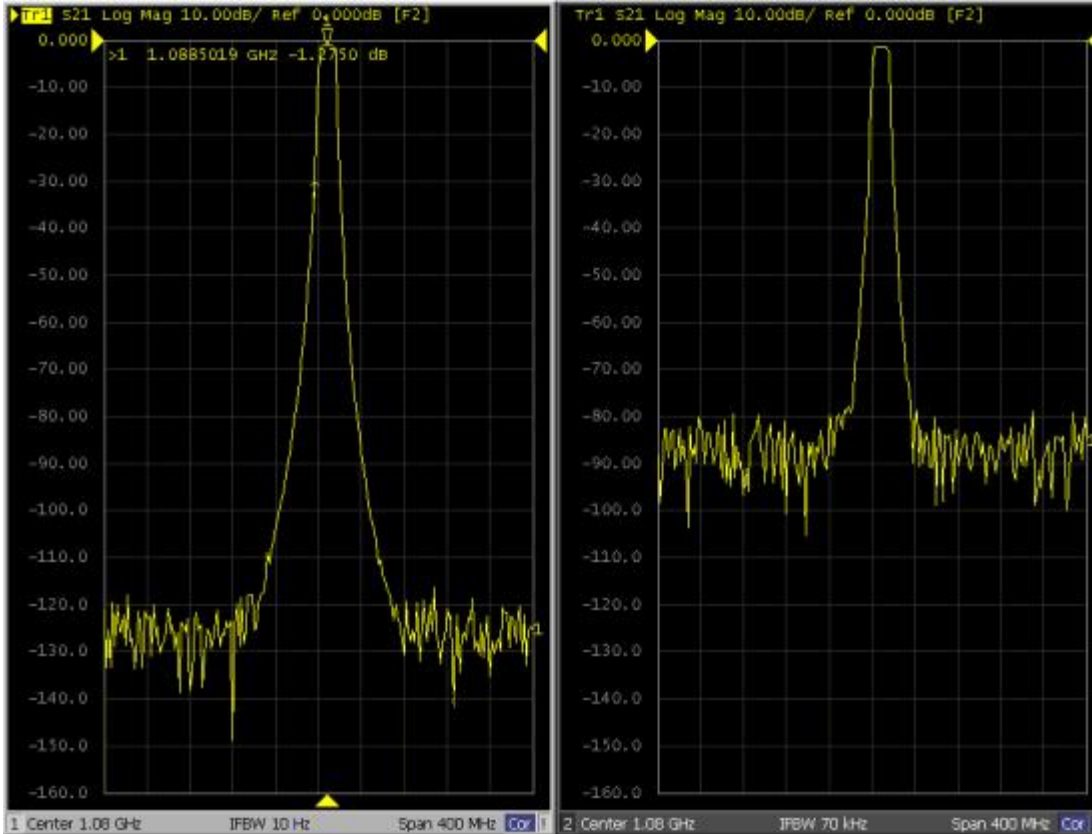

e5071c080

To specify the IF bandwidth, follow the steps described below.

1. Press **Channel Next** (or **Channel Prev**) to select a channel on which to specify the IF bandwidth.
2. Press **Avg** key.
3. Click **IF Bandwidth**, then change the IF bandwidth in the data entry area.

Setting IF Bandwidth Automatically

The IF bandwidth auto mode helps you to improve the measurement speed, when the sweep mode is set at log especially. When you make a measurement with wide span from lower frequency and the IF bandwidth is set at fixed frequency, the measurement would be slow or higher noise floor in lower frequency. This function allows you to measure narrower IF bandwidth (lower noise) in lower frequency and wider IF bandwidth (faster) in higher frequency.

1. Press **Avg** key.
2. Click **IFBW Auto** to turn ON the IF bandwidth auto mode.
3. If you want to set an upper limit of IF bandwidth in auto mode, press **IFBW Auto Limit**, and enter the upper limit with enter keys.

NOTE

In IF bandwidth auto mode, the IF bandwidth is automatically set to equal to or less than 1/5 of each measurement frequency. (The E5061B does not change IFBW for each test points in IF BW auto mode. The E5061B divides its measurement span into several segments which are defined internally. The IFBW is set at equal to or less than 1/5 of the start frequency of each segment.)

NOTE

IFBW Auto On may make the sweep time be longer than IFBW Auto Off. This is because IFBW auto operation requires some additional time.

Turning ON Sweep Averaging

Using sweep averaging also enables you to reduce the effects of random noise on the measurements.

Sweep averaging averages data from each point (vector quantity) based on the exponential average of a continuous sweep weighted by the averaging factor specified by the user. Sweep averaging is expressed in the following equation.

$$A_n = \frac{S_n}{F} + \left(1 - \frac{1}{F}\right) \times A_{n-1}$$

where:

- A_n = Result of the calculation of sweep averaging for the nth sweep operation at the point in question (a vector quantity)
- S_n = Measurement value obtained at the nth sweep operation at the point in question (a vector quantity)
- F = Sweep averaging factor (an integer between 1 and 999)

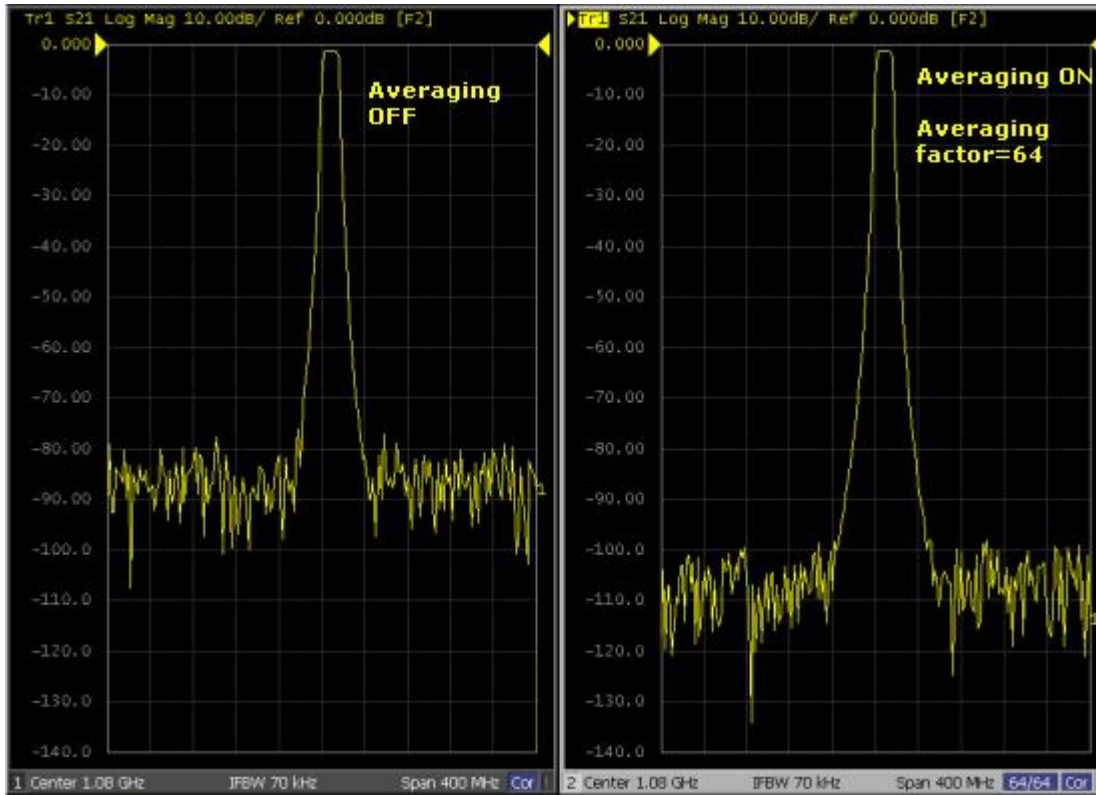

e5071c081

Define the sweep averaging by following the steps below.

1. Press **Channel Next** (or **Channel Prev**) to select the channel on which you want to define the sweep averaging.
2. Press **Avg** > **Avg Factor**, then change the averaging factor in the data entry area.
3. Click **Averaging** to turn ON the averaging.

NOTE

Clicking **Averaging Restart** resets n to 1 in Sweep Averaging equation in Turning on Sweep Averaging

Reducing Trace Noise

Any of the following methods can be used to lower the trace noise. This section provides the description of Turning on Smoothing.

- Turning on Smoothing
- Turning on Sweep Averaging
- Narrowing IF Bandwidth

Other topics about Optimizing Measurements

Turning on Smoothing

Smoothing can be used to reduce noise that has relatively small peaks. By turning on smoothing, the value of each point on a trace is represented by the moving average over the values of several nearby points. The smoothing aperture (percentage of sweep span) defines the range of points to be included in the calculation of the moving average.

NOTE

You can define the smoothing trace by trace.

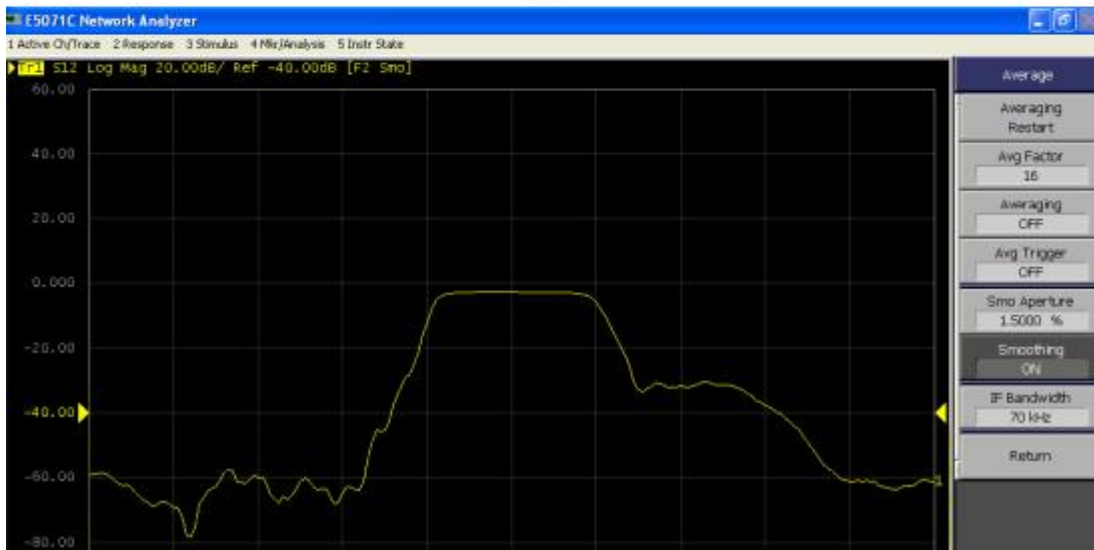
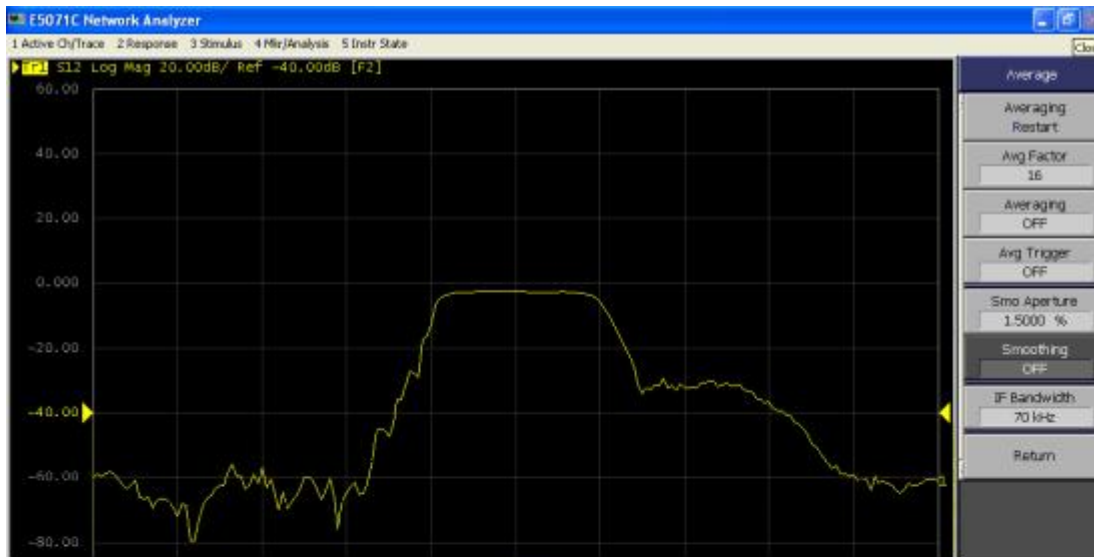

e5071c075

Setting up smoothing

Set up the smoothing operation by following the steps below:

1. Press **Channel Next** (or **Channel Prev**) and **Trace Next** (or **Trace prev**) to activate the trace on which smoothing will be defined.
2. Press **Avg**.
3. Click **Smo Aperture**, then change the smoothing aperture (%) in the data entry area.
4. Click **Smoothing** to turn ON smoothing. **Smo** is displayed at the trace status area.

Improving Phase Measurement Accuracy

This section describes the following functions that can be used to improve phase measurement accuracy.

- Electrical Delay
- Velocity Factor
- Phase Offset
- Port Extensions and Loss Values

Other topics about Optimizing Measurements

Electrical Delay

Electrical Delay is a function that adds or removes a pseudo-lossless transmission line with a variable length corresponding to the receiver input. Using this function enables you to improve the resolution in phase measurement and thereby measure the deviation from the linear phase. You can specify the electrical delay trace by trace.

1. Press **Channel Next** (or **Channel Prev**) and **Trace Next** (or **Trace prev**) to activate the phase trace of which you want to specify the electrical delay.
2. Press **Scale** > **Electrical Delay**.
3. Change the electrical delay (in seconds) in the data entry area.

For how to determine the deviation from a linear phase, see Measuring the Deviation from a Linear Phase.

Procedure using marker

1. Press **Channel Next** (or **Channel Prev**) and **Trace Next** (or **Trace prev**) to activate the trace of which you want to set the electrical delay.
2. Place the active marker in an appropriate position.
3. Press **Maker Fctn**.
4. Click **Marker -> Delay** to set the electrical delay to the group delay value at the position of the active marker (a value smoothed with the aperture of 20% regardless of the smoothing setting).

Phase offset

Phase offset is a function used to add or subtract a predetermined value relative to the frequency to and from the trace. Using this function enables you to simulate the phase offset which occurs as a result of, say, adding a cable.

The phase offset can be specified from -360° to $+360^\circ$.

Using the Phase Offset Function

1. Press **Channel Next** (or **Channel Prev**) and **Trace Next** (or **Trace prev**) to activate the trace of which you want to specify the phase offset.
2. Press **Scale > Phase Offset**, then enter the phase offset (°) in the data entry area.

Velocity factor

The velocity factor is the ratio of the propagation velocity of a signal in a coaxial cable to the propagation velocity of that signal in free space. The velocity factor for a common cable is about 0.66. The propagation velocity depends on the dielectric constant (ϵ_r) of the dielectric substance the cable.

$$\text{Velocity factor} = \frac{1}{\sqrt{\epsilon_r}}$$

By specifying the velocity factor, you can match the equivalent length (in meters) appearing in the data entry area to the actual physical length when using the Electrical Delay or Setting port extensions to specify the electrical delay (in seconds).

You can define the velocity factor channel by channel.

Using the velocity factor

1. Press **Channel Next** (or **Channel Prev**) to activate the channel for which you want to specify the velocity factor.
2. Press **Cal > Velocity Factor**, then the velocity factor in the data entry area.

Port Extensions and Loss Values

Overview

Port Extension is a function for moving the calibration reference plane by specifying the electrical delay. This function is useful, for example, when you cannot directly perform calibration at the DUT terminal because the DUT is inside the test fixture. In such a case, this function enables you to first perform calibration at the test fixture terminal and then move the calibration plane to the DUT terminal by extending the port.

Port extension corrects the electrical delay of each test port (phase shift) only. It cannot remove errors caused by the loss in and incorrect matching of cables, adapters, or test fixtures.

In addition to port extension, you can set loss values for each port. By correcting loss due to port extension, more accurate measurement results are obtained.

There are two types of loss value settings: loss values at two frequency points for a specified port, and a DC loss value. You can make these settings at the same time for each port.

The port extension is not available for the Gain-Phase measurement.

NOTE

You can set loss values channel by channel. Setting loss values for one particular channel does not affect other channels.

NOTE

You can define port extension channel by channel. Setting port extension for one particular channel does not affect other channels.

Enabling port extensions and loss values

1. Press **Channel Next** (or **Channel Prev**) to activate the channel for which you want to enable port extension.
2. Press **Cal** > **Port Extensions**.
3. Turn ON **Extensions**.

Setting port extension and Loss values manually.

a. Setting electrical delay

Follow the steps below to set the delay for coaxial cable:

1. Press **Channel Next** (or **Channel Prev**) to activate the channel for which you want to set port extension.
2. Press **Cal** > **Port Extensions**.
3. Click **Extension Port 1** or **Extension Port 2** to select the port.
4. Click **Extension** to set the extension in sec.

b. Setting loss values

1. Press **Channel Next** (or **Channel Prev**) to activate the channel for which you want to set loss values.
2. Press **Cal** > **Port Extensions**.
3. Click **Extension Port 1** or **Extension Port 2** to select the port.
4. Click **Loss** to set a loss value.
5. Click **Loss1 [OFF]** to toggle to **Loss1 [ON]** (enabled), and enter a loss value (**Loss1**) and a frequency (**Freq1**).
6. If you want to set loss at two frequency points, press **Loss2 [OFF]** to toggle to **Loss [ON]** (enabled), and enter a loss value (**Loss2**) and a frequency (**Freq2**).

- Expression to calculate loss using Loss 1:

$$\text{Loss}(f) = \text{Loss1} \times \sqrt{\left(\frac{f}{\text{Freq1}}\right)}$$

- Expression to calculate loss using Loss 1 and Loss 2:

$$\text{Loss}(f) = \text{Loss1} \times \left(\frac{f}{\text{Freq1}}\right)^n$$

$$n = \frac{\log_{10} \left| \frac{\text{Loss1}}{\text{Loss2}} \right|}{\log_{10} \frac{\text{Freq1}}{\text{Freq2}}}$$

NOTE

When you specify two frequency points, set the lower frequency to Loss1, and the higher one to Loss2.

c. Setting a DC loss value

1. Click **Cal** > **Port Extensions** > **Extension Port 1** or **Extension Port 2** to select the port.
2. Click **Loss** > **Loss1 [OFF]** to toggle to **Loss1 [ON]** (enabled).
3. Click **Loss at DC**, then enter a DC loss value.

Using the auto port extension function

The auto port extension function measures port extension and loss values for each port using the OPEN/SHORT standard connected to the port, automatically calculates and sets them.

When the auto port extension function is completed, the port extensions and loss values are updated to the calculated values.

You can use both open and short measurement values in the auto port extension function. Note that in this case, the average value of the calculation results is used for updating.

You can set the auto port extension function channel by channel. Setting the auto port extension function for one particular channel does not affect other channels.

When the sweep type is power sweep, the auto port extension is not available.

A. Selecting a port(s)

Select the port(s) of which you want to use the auto port extension function.

1. Press **Channel Next** (or **Channel Prev**) to activate the channel of which you want to set auto port extension.
2. Press **Cal** > **Port Extensions** > **Auto Port Extension** > **Select Ports** to select the port(s) of which you want to use the auto port extension function.

B. Setting frequencies used for calculation

Set the frequency points of which you want to calculate a loss value.

1. Press **Cal** > **Port Extensions** > **Auto Port Extension** > **Select Ports** > **Method** to set **the frequencies used for calculation**.
2. If you have selected **User Span**, use **User Span Start** and **User Span Stop** to set a start value and a stop value.

NOTE For **Current Span** and **User Span**, a frequency point at 1/4 of the frequency range is set to **Freq1**; a frequency point at 3/4 of the frequency range is set to **Freq2**.

NOTE If the setting is not made before starting OPEN/SHORT standard measurement, it does not affect the calculation result.

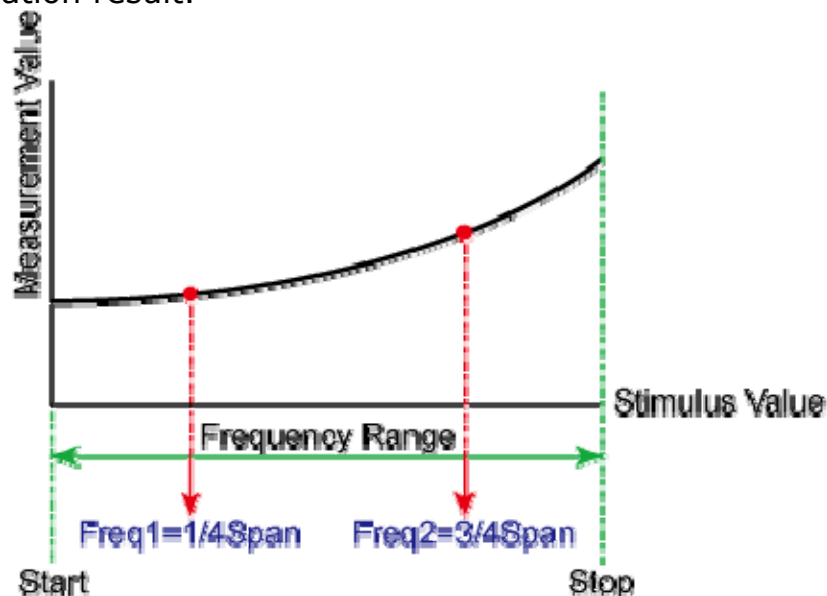

e5071e466

C. Specifying a loss value as a calculation target

Specify whether you want to include a loss value in the calculation result.

1. Press **Cal** > **Port Extensions** > **Auto Port Extension** > **Select Ports** > **Include Loss** to turn it ON.

NOTE

If the setting is not made before starting the measurement of the OPEN/SHORT standard, it does not affect the calculation result.

D. Specifying a DC loss value as a calculation target

Specify whether you want to include a DC loss value in the calculation result.

1. Press **Cal** > **Port Extensions** > **Auto Port Extension** > **Adjust Mismatch** to turn it ON.

NOTE

If the setting is not made before starting the measurement of the OPEN/SHORT standard, it does not affect the calculation result.

E. Measuring the OPEN/SHORT standard and executing calculation

Calculate port extensions and loss values based on the calculation results using the OPEN/SHORT standard.

1. Press **Cal** > **Port Extensions** > **Auto Port Extension**.
2. If you use the OPEN standard, click **Measure OPEN**, and select the port(s) of which you want to execute measurement. Execution is restricted to ports selected in Selecting a port(s)
3. If you use the SHORT standard, click **Measure SHORT**, and select the port(s) of which you want to execute measurement. Execution is restricted to ports selected in Selecting a port(s).

NOTE

If a port extension value or loss value has been set, the value is updated to the calculated result.

NOTE

If you execute both open measurement and short measurement, the average of the calculation results is reflected to the port extension and loss value.

F. Deleting the result of open/short measurement

When you exit from the softkey menu in the same level after open/short measurement, the measurement results are deleted. Note that you can use a GPIB command.

NOTE

Port extension and loss values that have been calculated are not cleared.

Improving Measurement Throughput

This section explains the methods to improve measurement throughput.

- Turning OFF the updating of information displayed on the LCD screen

Other topics about Optimizing Measurements

Turning OFF the updating of information displayed on the LCD screen

Turning OFF the updating information feature displayed on the LCD screen eliminates the processing time required to update displays within the analyzer, hence improves the measurement throughput. If it is not necessary to check displayed information during measurements, turning OFF real-time updating is an effective means of improving throughput.

The updating of information displayed on the LCD screen can be switched using the following procedure:

Turning OFF the updating of information

1. Press **Display**.
2. Click **Update** to switch the updating of displayed information on the LCD screen ON/OFF.

When the LCD screen update is turned OFF, **Update Off** appears on Instrument Status Bar.

Measurement Examples

Measurement Examples

- Band Pass Filter Measurement (in Quick Start)
- Loop Gain Stability Measurement
- Performing Segment-by-Segment Sweep (segment sweep)

Measurement Example of a Bandpass Filter

This section describes how to measure the transmission characteristics of a 947.5 MHz bandpass filter. The measurement conditions for this measurement example are those suitable for a 947.5 MHz bandpass filter. To measure another device under test (DUT), change the measurement conditions to suit the particular DUT.

STEP 1. Determining Measurement Conditions

1. Preset the E5061B.

Preset > OK

2. Set the S-parameter to S21.

Meas > S21

NOTE

When measuring the reverse transmission characteristics, set the S-parameter to S12.

3. Set the data format to the log magnitude format

Format > Log Mag

4. Set the center frequency to the bandpass filter center frequency. Next, specify the span frequency, which is set to 200 MHz in this measurement example.

Center > 9 > 4 > 7 > . > 5 > M/m

Span > 2 > 0 > 0 > M/m

NOTE

When entering the frequency unit using the keyboard, type "G" for GHz, "M" for MHz, and "k" for kHz.

5. Specify the number of measurement points per sweep. The number of measurement points in this measurement example is set to 401.

Sweep Setup > Points > 4 > 0 > 1 > x1

6. Specify the power level of the signal source. The power level in this measurement example is set to -10 dBm.

Sweep Setup > Power > +/- > 1 > 0 > x1

7. Specify the IF bandwidth of the receiver as necessary. In this measurement example, the IF bandwidth is set to 10 kHz because of the need to lower the noise floor.

Avg > IF Bandwidth > 1 > 0 > k/m

STEP 2. Calibration

To turn the error correction ON, set the calibration type to the full 2-port calibration and measure the calibration data.

For details about calibration, see Calibration.

1. Select the calibration kit suitable for the measurement cable. In this measurement example, Calibration Kit 85032F is selected.

Cal > Cal Kit > 85032F

2. Set the calibration type to the full 2-port calibration using the test port 1 and 2.

Cal > Calibrate > 2-Port Cal

3. Connect the OPEN standard (included in the calibration kit) to the other end of the measurement cable that is connected to the test port 1 as shown in the following figure, and measure the open calibration data at the test port 1. After measuring the open calibration data, a checkmark  is displayed to the left of the **Port 1 Open** menu.

Cal > Calibrate > 2-Port Cal > Reflection > Port1 Open

In the same way, measure the calibration data for the SHORT/LOAD standards at the test port 1.

Connecting the OPEN/SHORT/LOAD standards

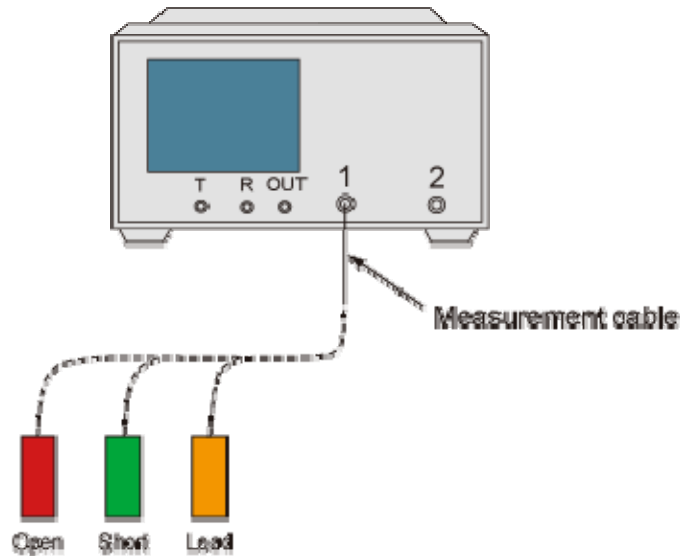

e5061b-042

4. In the same way as described above, measure the calibration data for the OPEN/SHORT/LOAD standards at the test port 2.
5. Connect the measurement cables as shown in the figure below, and measure the thru calibration. After measuring the thru calibration data, a checkmark is displayed to the left of the **Port 1-2 Thru** button.

Cal > **Calibrate** > **2-Port Cal** > **Transmission** > **Port 1-2 Thru**

Making the through calibration

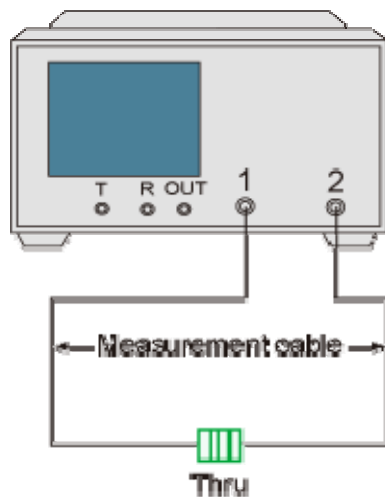

e5061b-044

6. Set the full 2-port calibration measurement to DONE. The calibration factor is calculated based on the calibration data acquired, and the error correction is turned ON.

Cal > Calibrate > 2-Port Cal > Done

7. Select the type in which the data is to be saved before saving the calibration factor (calculated based on the calibration data).

Save/Recall > Save Type > State & Cal

8. Store the calibration file to the disk of the E5061B. The symbol "X" appearing in the operations below represent the assigned numbers to be used when the file is saved.

Save/Recall > Save State > State 0X

STEP 3. Connecting the Device Under Test (DUT)

1. Connect to the DUT to the E5061B. (See the below figure)

Connecting the DUT

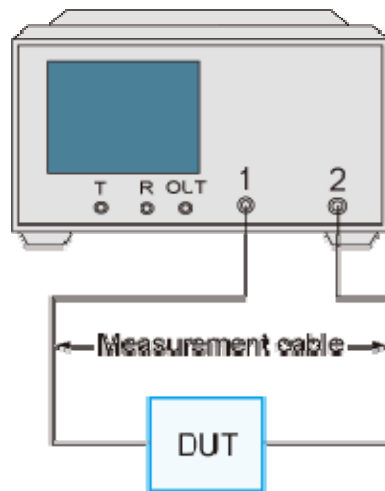

e7061b04

2. Set the appropriate scale by executing the auto scale. (See the below figure)

Scale > Auto Scale

You can also adjust the scale by entering arbitrary values in the **Scale/Div** button, **Reference Position** button, and **Reference Value**.

S21 trace after executing the auto scale



STEP 4. Analyzing Measurement Results

This section describes how to use the marker function to read out important parameters for the transmission measurement of the bandpass filter (insertion loss, -3 dB bandwidth).

Measuring the Insertion Loss

1. Display a marker.

Marker > Marker 1

2. Using one of the following methods to move the marker to the center frequency of the bandpass filter.
 - On the entry bar, press **9 > 4 > 7 > . > 5 > M/m**
 - Turn the rotary knob  on the front panel to set it to the center frequency (947.5 MHz).
3. Read the marker value displayed as shown in the figure below. In this example, the response value denotes the insertion loss.

Measuring an Insertion Loss



Measuring the -3 dB Bandwidth

Using the marker bandwidth search function, the bandwidth, center frequency between two cutoff frequency points, Q value, and insertion loss are all read out. These parameters are described in the following table.

NOTE If the two cutoff frequency points are not found, all data items except the insertion loss revert to zero.

Parameter	Description
BW (Bandwidth)	Stimulus width between two cutoff frequency points (low and high)
cent (Center Frequency)	Center point between cutoff frequency points (low and high)
low (Left-side Cutoff Frequency)	The lower frequency of the two cutoff frequency points
high (Right-side Cutoff)	The higher frequency of the two cutoff

Frequency)	frequency points
Q (Q Value)	$Q = \text{cent}/\text{BW}$
loss (Insertion Loss)	The measured value of the active marker.

1. Display a marker.

Marker > Marker 1

2. Using one of the following methods to move the marker to the center frequency of the bandpass filter.

- On the entry bar, press **9 > 4 > 7 > . > 5 > M/m**
- Turn the rotary knob  on the front panel to set it to the center frequency (947.5 MHz).

3. Specify the bandwidth definition value that defines the pass band of the filter. In this measurement example, it is set to -3 dB.

Marker Search > Bandwidth Value > +/- > 3 > x 1

4. Set the bandwidth search function ON.

Marker Search > Bandwidth

5. The bandwidth data items (BW, cent, low, high, Q, loss) is displayed. (See the following figure.)

Measuring the -3 dB Bandwidth

STEP 5. Outputting Measurement Results (Save)

You can save not only the internal data but also the measurement results such as trace data and display screens to the disk.

Saving the Trace Data(in CSV format)

You can save the trace data to the disk of the E5061B in CSV file format (extension: .csv). Since the CSV-formatted data to be saved is a text file, you can analyze the data using Microsoft Excel.

Follow the step below to save the trace data:

Save/Recall > Save Trace Data

Saving the Display Screen

You can save the screen displayed on the E5061B to the disk of the E5061B in Windows bitmap file format (extension: .bmp) or Portable Network Graphics format (extension: .png).

Follow the step below to save the display screen:

System > Dump Screen Image

E5061B

NOTE

The image on the LCD display memorized in the volatile memory (clipboard) (the image on the LCD display when the **Capture/System** key is pressed) is saved.

Loop Gain Stability Measurement

- Overview
- Procedure

Other Measurement Examples

Overview

This section introduces an example of how to measurement loop stability for low-frequency amplifier.

Procedure

In this example, the DUT is evaluated by following the steps.

Step	Description
1. Setting the Measurement Conditions	Set the measurement conditions.
2. Executing Calibration	Execute calibration.
3. Connecting the DUT	Connect the DUT.
4. Scaling	Adjust the scale to confirm the result of measurement.

1. Setting the Measurement Conditions

The measurement conditions are defined by following the steps described below.

Setup Description	Key Operation
Presetting	Preset > OK
Setting trace number: 2	Display > Num of Traces > 2 > Allocate Traces > x2
Specifies measurement port: Gain-Phase	Meas > Measurement Port > Gain-Phase <div style="background-color: #cccccc; padding: 2px; display: inline-block; margin-bottom: 5px;">NOTE</div> The measurement parameters are not specified, because the measurement parameters of both channel are T/R.

Specifies impedance of receiver port: 1 M Ω	Meas > Gain-Phase Setup > T Input Z > 1 MΩ Meas > Gain-Phase Setup > R Input Z > 1 MΩ
Specifies attenuator of receiver port: 20 dB	Meas > Gain-Phase Setup > T Attenuator > 20 dB Meas > Gain-Phase Setup > R Attenuator > 20 dB
Data format: Tr1:LogMag Tr2:Phase	(Tr1) Format > Log Mag (Tr2) Format > Phase
Sweep type: Log Frequency	Sweep Setup > Sweep Type > Log Freq
Start frequency: 100 Hz	Start > 1 > 0 > 0 > x1
Stop frequency: 1 MHz	Stop > 1 > M/u
IF bandwidth auto: ON	Avg > IFBW Auto (Turn it ON.)
IF bandwidth auto limit: 100 Hz	Avg > IFBW Auto Limit > 1 > 0 > 0 > x1
Power: -20 dBm	Sweep Setup > Power > Power > +/- > 2 > 0 > x1

2. Executing Calibration

The THRU response calibration (Gain-Phase) is executed.

Setup Description	Key Operation or Connecting Operation
Connect THRU connection	Connect THRU connection.
Executing the THRU response	Cal > Calibrate > Response (Thru) > Thru > Done

3. Connecting the DUT

Connect the DUT as shown below.

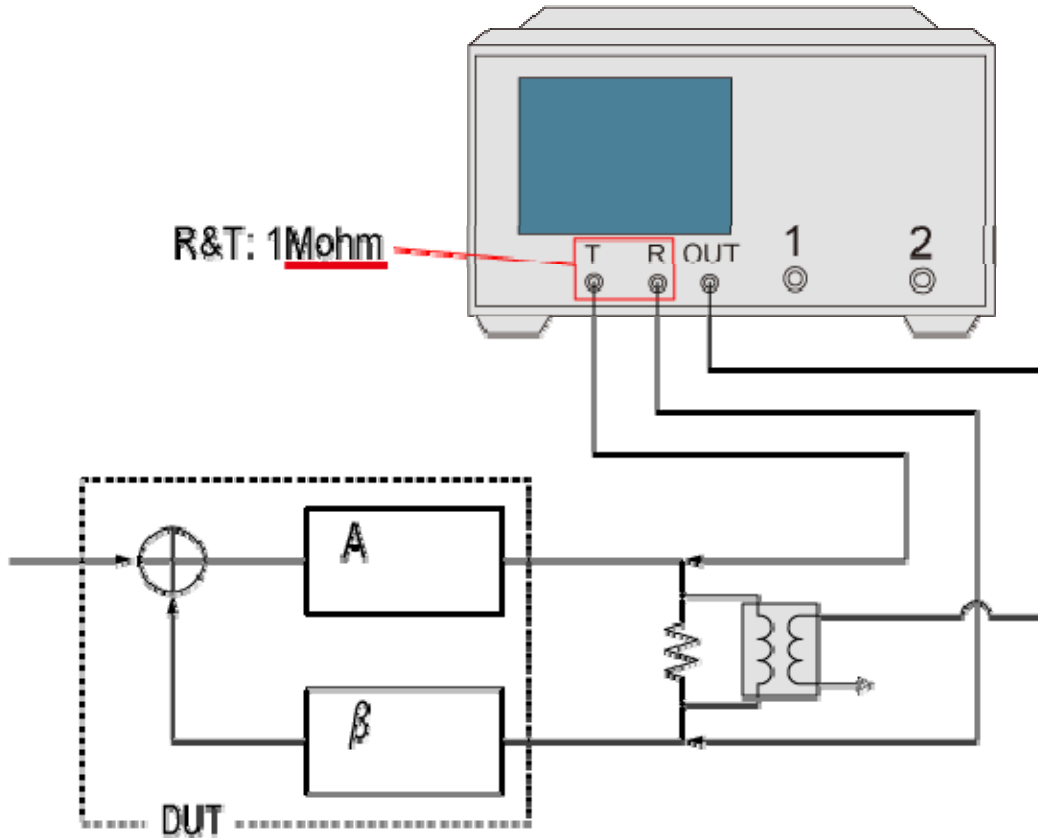

e3061b066

4. Scaling

Set each parameter for the scale setting. It is necessary to specify the trace pressing the **Trace Next** or **Trace Prev** before each parameter is specified. The following table is example of setting.

Setup Description	Key Operation
Scale divisions: 10	(Tr1) Scale > Divisions > 1 > 0 > x1 (Tr2) Scale > Divisions > 1 > 0 > x1
Scale/Div: 10 dB/div (Tr1), 45 °/div (Tr2)	(Tr1) Scale > Scale/Div > 1 > 0 > x1 (Tr2) Scale > Scale/Div > 4 > 5 > x1
Reference position: 5 Div	(Tr1) Scale > Reference Position > 5 > x1 (Tr2) Scale > Reference Position > 5 > x1
Reference value: 0 dB (Tr1), 0 °/div (Tr2)	(Tr1) Scale > Reference Value > 0 > x1 (Tr2) Scale > Reference Value > 0 > x1

Example of the loop gain stability measurement screen

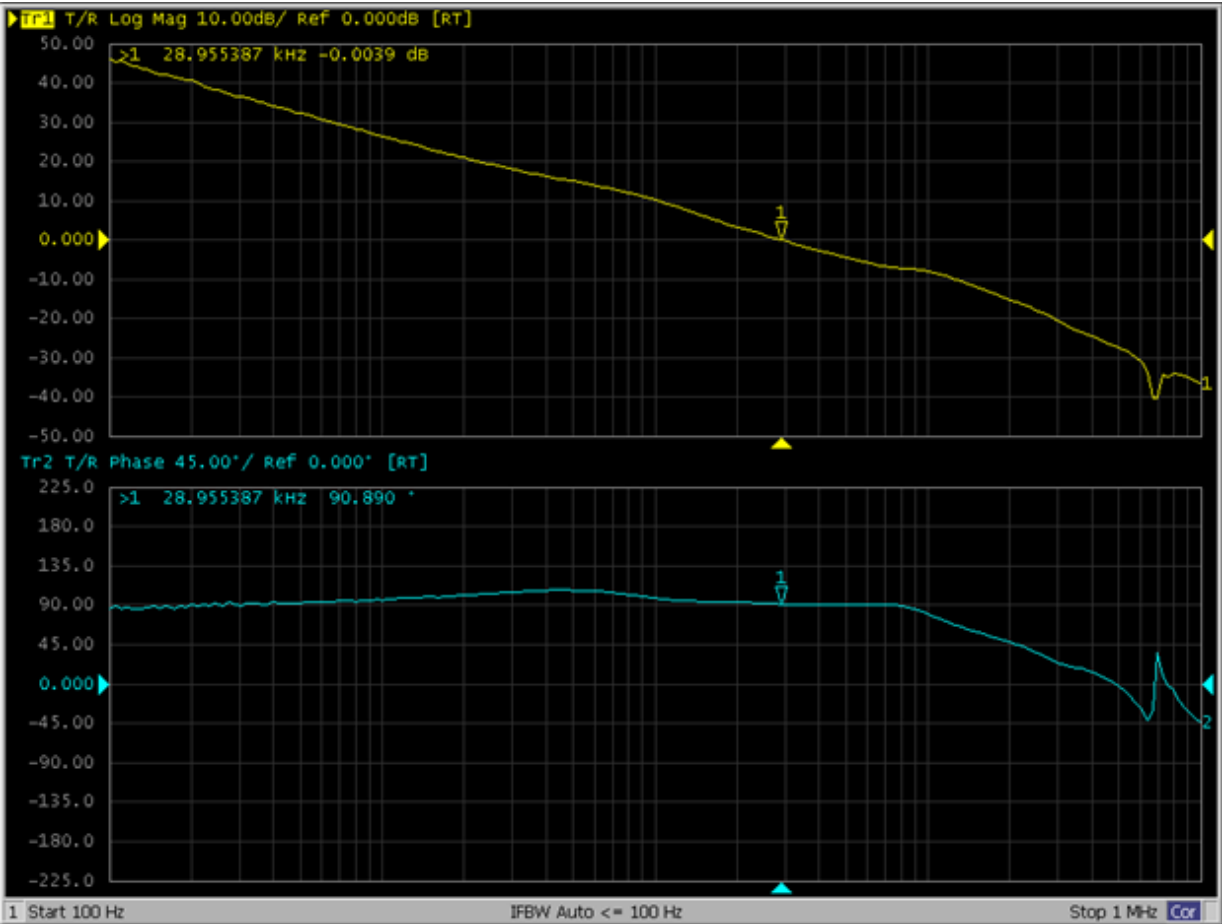

Performing a Segment-by-Segment Sweep

This section describes the concept of the segment sweep and how to perform it.

- [Concept of Segment Sweep](#)
- [Conditions for Setting Segment Sweep](#)
- [Items that can be set for Each Segment](#)
- [Sweep Delay/Sweep Time in Segment Sweep](#)
- [Frequency/Order Base Display](#)

Other topics about Optimizing Measurements

Concept of Segment Sweep

To perform a segment sweep, you must define two or more frequency ranges, called segments, and then specify the number of points, IF bandwidth, power level, sweep delay time, and sweep time for each segment. All segments are swept sequentially as if swept in one sweep operation.

NOTE By skipping the frequency range, which does not need to be measured, you can sweep and measure only the portions you need.

NOTE You can define the optimum measurement conditions for each of the segments you designate. For example, you can specify as many points as possible in a segment requiring high trace resolution and as few points as possible in a segment not requiring high resolution. This shortens the measurement time, enabling you to optimize the overall measurement throughput by not having to perform the entire operation under the same measurement conditions of a particular frequency range.

To evaluate a band pass filter that has the transmission characteristics shown in the following figure, for example, you can select the frequency ranges you need from A through G and determine the measurement conditions shown in the table below. This enables you to measure them simultaneously in one sweep operation.

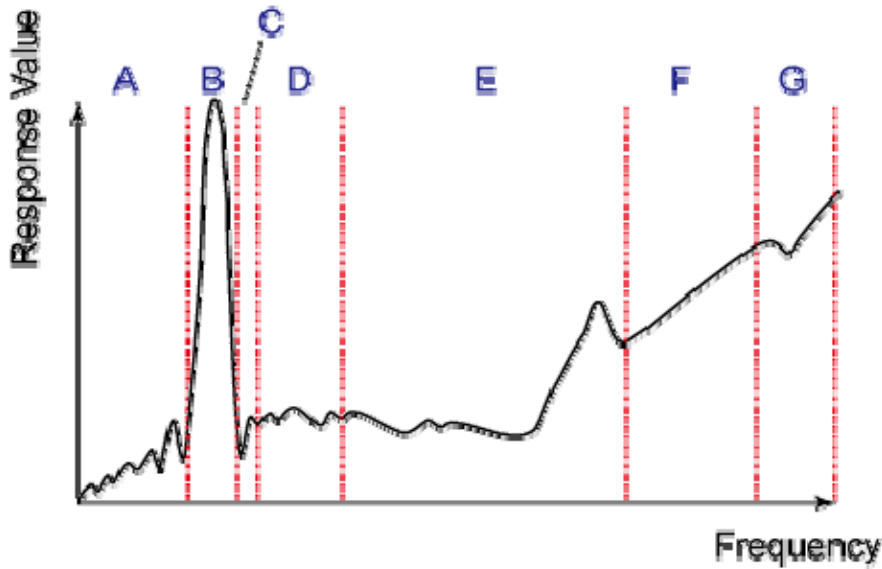

e5071c389

Frequency ranges (segments) from the figure above and their measurement conditions				
	Start frequency	Stop frequency	Number of points	IF Bandwidth
A	440 MHz	915 MHz	50	50 kHz
B	915 MHz	980 MHz	130	70 kHz
C	980 MHz	1.035 GHz	60	50 kHz
E	1.07 GHz	2 GHz	100	70 kHz
G	2.6 GHz	3 GHz	40	70 kHz

Conditions for Setting Segment Sweep

The following conditions apply in setting up a segment sweep.

- The frequency range of a segment must not overlap with that of another segment. (The start frequency of a segment must be higher than the stop frequency of the immediately preceding segment).
- The start frequency of segment 1 must be greater than 5 Hz and the stop frequency of the last segment less than 3 GHz, as per the range of the Network Analyzer.

- When the start frequency and stop frequency of a segment are not the same, you can define from 2 to the maximum points in a segment.
- When the start frequency and stop frequency of a segment are the same, you can define from 1 to the maximum points in a segment.
- You can set the total number of points in the segment table from 2 to the maximum points.
- You can set the number of segments in the segment table to between 1 and 201.

Items that can be set for Each Segment

For the segment sweep, you can set the sweep range, the number of points, IF bandwidth, power level, sweep delay time, and sweep time for each segment.

You can set the items in the following table to ON/OFF for each segment. If you enable the segment-by-segment setting, you can make the setting for each segment in the segment table; if you disable it, the setting in the following table is used.

Item	When segment-by-segment setting is disabled
IF bandwidth	For all segments, the IF bandwidth (set with Avg > IF Bandwidth) is set even if IFBW AUTO is turned ON.
Power level	For all segments, the power level for the linear/log sweep (set with Sweep Setup > Power) is set.
Sweep delay time	For all segments, 0 is set.
Sweep time	For all segments, the auto sweep time mode is set.

Sweep Delay/Sweep Time in Segment Sweep

The definitions for sweep delay time and sweep time, which you can specify in the segment sweep, are shown in below figures.

The definitions for sweep delay time and sweep time when trigger mode is "On Sweep".

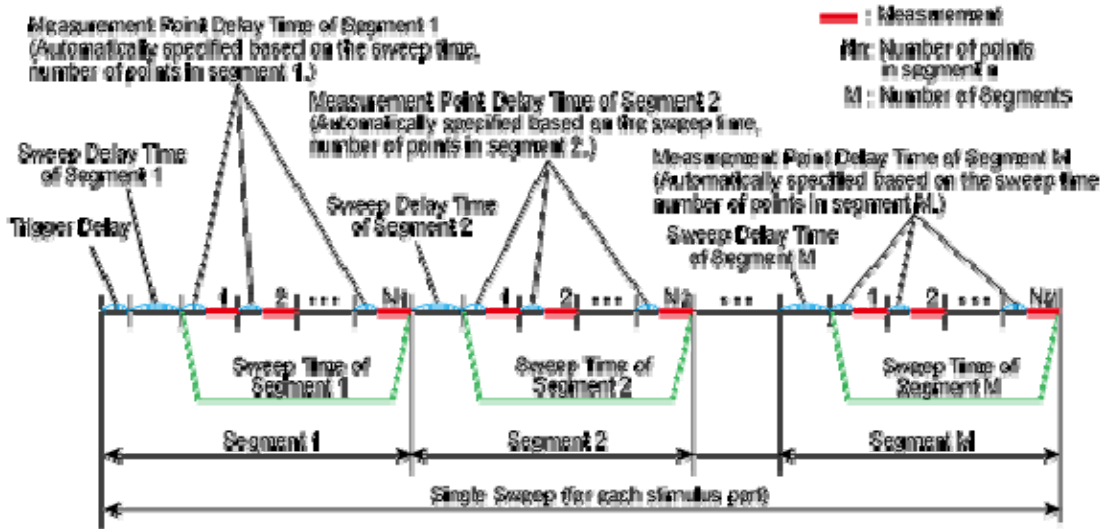

e5061b038

The definitions for sweep delay time and sweep time when trigger mode is "On Point".

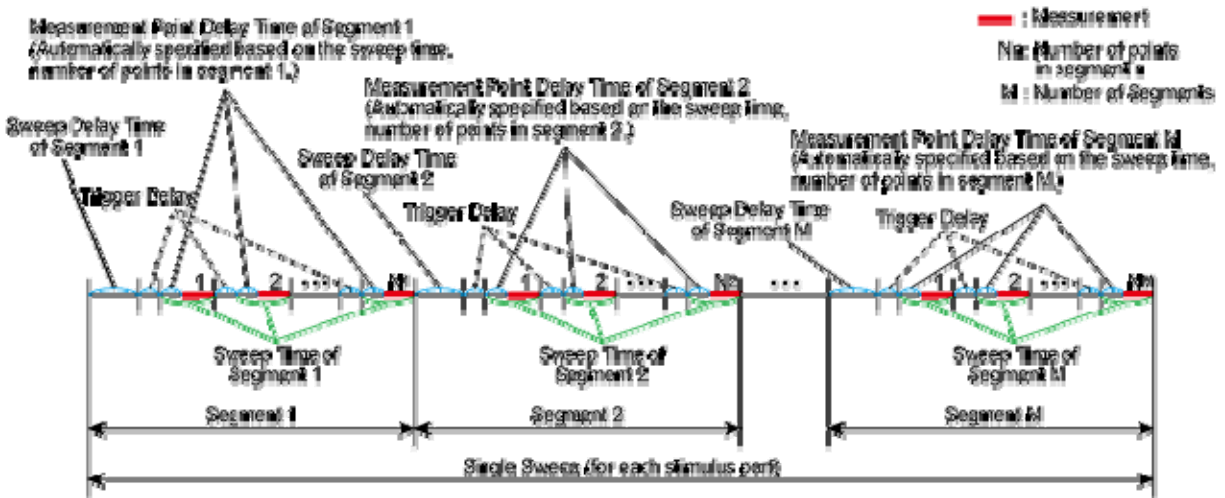

e5061b039

NOTE

The segment trigger delay is not included in the segment sweep time.

Frequency/Order Base Display

You can choose between frequency-based and order-based display as the method of displaying traces when executing a segment sweep.



Frequency based Display

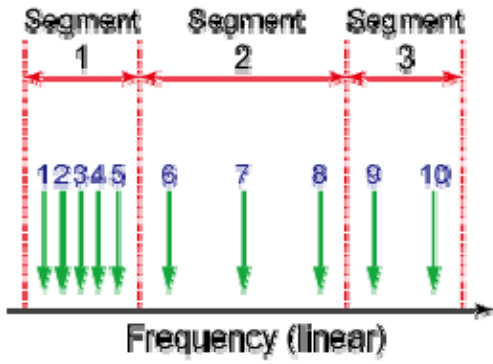

Order based Display

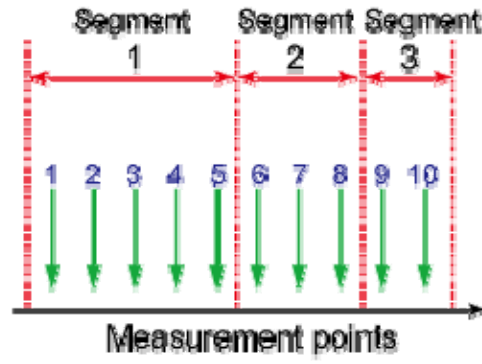

e5071c384

Procedure
Creating a segment table

1. Press **Channel Next** (or **Channel Prev**) to select the channel of which you want to create the segment table.
2. Press **Sweep Setup**.
3. Click **Edit Segment Table**. The segment table appears in the lower section of the screen.
4. Select the **softkey** to change the frequency range setting mode or to set the IF bandwidth, power level, sweep delay time, and sweep time for each segment.

NOTE

When setting the segment table using the front panel keys or keyboard, you need to place focus on (select) the operation target (segment table of softkey) first. You can change the focus by pressing **Foc** key in the **ENTRY** Block. When the focus is placed on the segment table, the window frame of the segment table is displayed as bright as the window frame of the active channel. When the focus is placed on the softkey menu, the softkey menu title area is displayed in blue.

5. Enter each item in the following table for each added segment (line) to create the segment table. To create the segment table, use the hardkeys and softkeys.

Start	Sets the start value of the sweep range
Stop	Sets the stop value of the sweep range
Center	Sets the center value of the sweep range
Span	Sets the span value of the sweep range
Points	Sets the number of points
IFBW	Sets the IF bandwidth
Power	Sets the power level; the power range is common to the settings for the linear/log sweep (Sweep Setup > Power Range_s)
Delay	Sets the sweep delay time
Time	Sets the sweep time; to specify the auto setting (AUTO), enter 0 as the sweep time

Useful functions when using a mouse

- You can **copy/paste/insert/delete** the cell by right-clicking on the selected cell.
- In the character-by-character edit mode, you can **undo/cut/copy/paste/delete/select all** by right-clicking in the cell.

Executing segment sweep

To execute a segment sweep by using the segment table you have created, you must specify the sweep type for that sweep operation by following the steps below.

1. Press **Channel Next** (or **Channel Prev**) to select the channel on which you execute the segment sweep operation.
2. Press **Sweep Setup > Sweep Type > Segment**.

Setting up the segment display

Define the method of displaying traces when the segment sweep is executed by following the steps described below.

1. Press **Channel Next** (or **Channel Prev**) to select the channel on which you define the segment display.
2. Press **Sweep Setup > Segment Display**.
3. Select the **segment display**.

Saving a newly created segment table in CSV format

As discussed in Creating a segment table, you can export the newly created segment table as a CSV (comma-separated value) formatted file (so it can be used easily in software that requires a different format).

1. Press **Sweep Setup**.
2. Click **Edit Segment Table > Export to CSV File** to open the Save As dialog box. Note that CSV files (*.csv) is already selected as the file type when the dialog box first opens.
3. Type the file name in the File Name area and Click **Save** to save the segment table.

Calling a segment table saved in CSV Format

By importing a segment table file saved by E5061B, you can set up the segment table.

NOTE

It is possible to recall a file from a different channel where it is saved.

1. Press **Sweep Setup**.

2. Click **Edit Segment Table > Import from CSV File** to open the Open dialog box. Note that CSV files (*.csv) is already selected as the file type when the dialog box first opens.
3. Select the CSV format file to be imported, and click **Open** to call up the segment table.

NOTE

You cannot import a CSV-formatted file created/edited in spreadsheet software into the E5061B.