

Connectorized Amplifier

ZX60-3018G+

50Ω 20 MHz to 3 GHz

Features

- Wide bandwidth, 20 MHz to 3 GHz
- Low noise figure, 2.7 dB typ.
- Output power up to 12.8 dBm typ.
- Protected by US patent 6,790,049

Applications

- Buffer amplifier
- Cellular
- PCS
- Lab
- Instrumentation
- Test equipment



CASE STYLE: GC957

Connectors	Model	Price	Qty.
SMA	ZX60-3018G-S+	\$49.95 ea.	(1-9)

+RoHS Compliant

The +Suffix identifies RoHS Compliance. See our web site for RoHS Compliance methodologies and qualifications

Electrical Specifications at $T_{AMB} = 25^{\circ}C$

MODEL NO.	FREQ. (GHz) $f_L - f_U$	DC VOLTAGE @ Pin V+ (V)	GAIN over frequency in GHz Typ (dB)					MAXIMUM POWER (dBm) Output (1 dB Comp.) Typ. f_L f_U		DYNAMIC RANGE NF (dB) Typ. IP3 (dBm) Typ.		VSWR (:1) Typ. In Out		ACTIVE DIRECTIVITY (dB) Isolation-Gain Typ.	DC OPERATING CURRENT @ Pin V+ (mA) Typ. Max.	
			0.1	1.0	2.0	3.0	Min.at 2 GHz									
ZX60-3018G+	0.02 - 3	12.0	22.8	21.9	20.3	18.8	18.0	12.8	10.2	2.7	25.0	1.3	1.4	2-6	34	45

Maximum Ratings

Operating Temperature	-45°C to 85°C case
Storage Temperature	-55°C to 100°C
DC Voltage	12.5V
Input Power(no Damage)	13dBm
Power	0.7W

Permanent damage may occur if any of these limits are exceeded.

Outline Drawing

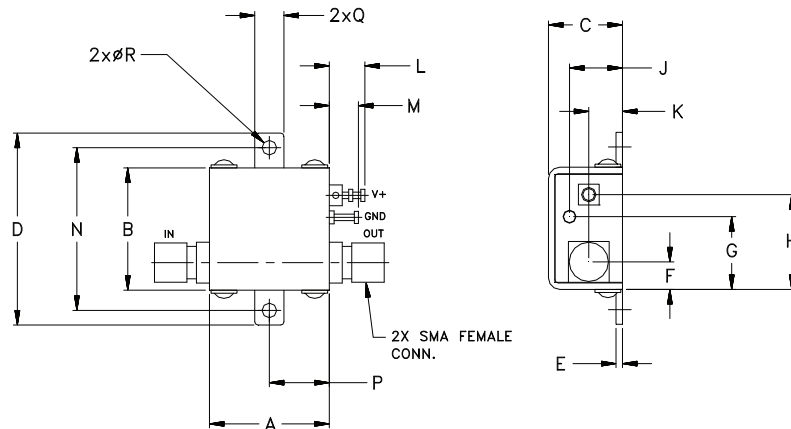

Outline Dimensions (inch mm)

A	B	C	D	E	F	G	H	J	K	L	M	N	P	Q	R	WT. GRAM
.74	.75	.46	1.18	.04	.17	.45	.59	.33	.21	.22	.18	1.00	.37	.18	.106	23.0
18.80	19.05	11.68	29.97	1.02	4.32	11.43	14.99	8.38	5.33	5.59	4.57	25.40	9.40	4.57	2.69	



For detailed performance specs & shopping online see web site

P.O. Box 350166, Brooklyn, New York 11235-0003 (718) 934-4500 Fax (718) 332-4661 The Design Engineers Search Engine Provides ACTUAL Data Instantly at minicircuits.com

Notes: 1. Performance and quality attributes and conditions not expressly stated in this specification sheet are intended to be excluded and do not form a part of this specification sheet. 2. Electrical specifications and performance data contained herein are based on Mini-Circuit's applicable established test performance criteria and measurement instructions. 3. The parts covered by this specification sheet are subject to Mini-Circuits standard limited warranty and terms and conditions (collectively, "Standard Terms"); Purchasers of this part are entitled to the rights and benefits contained therein. For a full statement of the Standard Terms and the exclusive rights and remedies thereunder, please visit Mini-Circuits' website at www.minicircuits.com/MCLStore/terms.jsp.

REV. B
M113397
EDR-6178/4
ZX60-3018G+
RAV
121022
Page 1 of 2

Typical Performance Data & Curves at 25°C

ZX60-3018G+

FREQUENCY (MHz)	GAIN (dB)	DIRECTIVITY (dB)	VSWR IN (:1)	VSWR OUT (:1)	POWER OUT @1dB COMPRESSION (dBm)	IP3 (dBm)	NF (dB)
20	22.58	2.30	1.16	1.32	12.80	25.61	2.92
50	22.75	2.12	1.15	1.27	13.05	25.87	2.66
100	22.76	2.00	1.15	1.25	12.94	25.89	2.61
351	22.61	2.22	1.18	1.27	12.92	25.39	2.69
500	22.42	2.36	1.21	1.29	12.94	25.26	2.72
663	22.28	2.61	1.25	1.33	12.88	25.39	2.66
866	21.83	3.17	1.30	1.33	12.73	25.67	2.69
1000	21.83	3.03	1.31	1.39	12.76	25.66	2.64
1168	21.52	3.35	1.34	1.42	12.69	25.66	2.60
1378	21.16	3.74	1.38	1.46	12.51	25.64	2.59
1500	20.97	3.85	1.40	1.47	12.41	25.45	2.59
1671	20.60	4.23	1.41	1.47	12.15	25.80	2.60
1863	20.39	4.54	1.40	1.50	12.16	25.64	2.62
2000	20.22	4.66	1.40	1.51	11.89	25.08	2.63
2174	20.04	4.83	1.40	1.51	11.72	24.67	2.62
2376	19.76	5.15	1.39	1.49	11.39	23.90	2.61
2500	19.56	5.46	1.38	1.48	11.25	23.54	2.58
2668	19.26	5.50	1.37	1.48	10.65	22.94	2.60
2879	18.97	5.83	1.35	1.46	10.42	22.62	2.61
3000	18.78	6.14	1.34	1.45	10.09	22.36	2.64

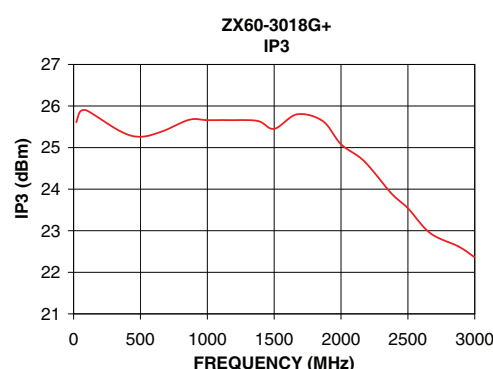
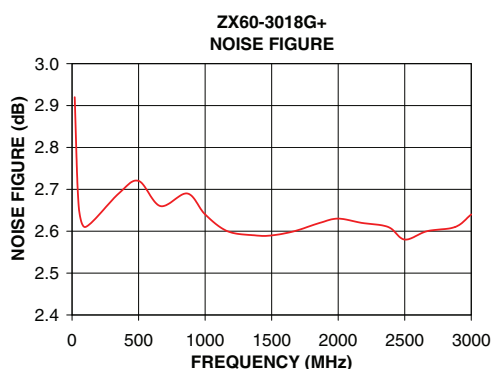
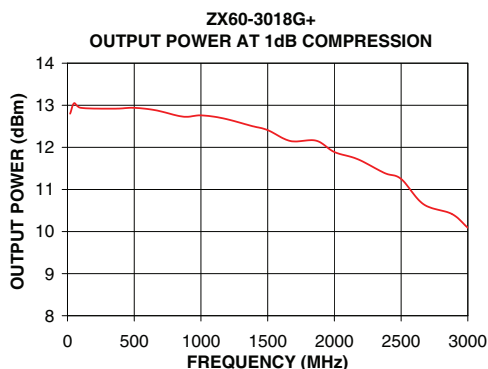
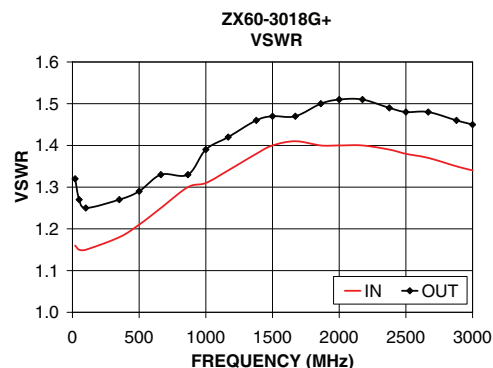
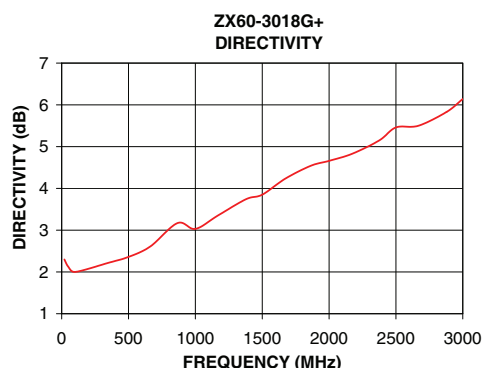
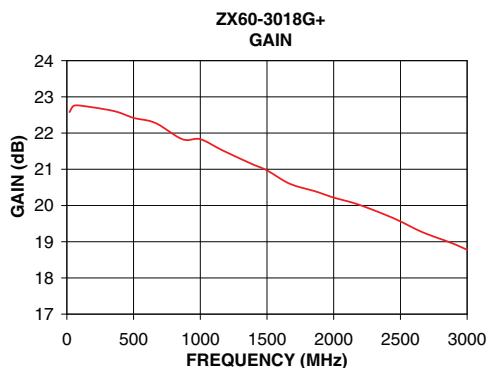

For detailed performance specs & shopping online see web site

P.O. Box 350166, Brooklyn, New York 11235-0003 (718) 934-4500 Fax (718) 332-4661 The Design Engineers Search Engine  Provides ACTUAL Data Instantly at minicircuits.com

Notes: 1. Performance and quality attributes and conditions not expressly stated in this specification sheet are intended to be excluded and do not form a part of this specification sheet. 2. Electrical specifications and performance data contained herein are based on Mini-Circuit's applicable established test performance criteria and measurement instructions. 3. The parts covered by this specification sheet are subject to Mini-Circuits standard limited warranty and terms and conditions (collectively, "Standard Terms"); Purchasers of this part are entitled to the rights and benefits contained therein. For a full statement of the Standard Terms and the exclusive rights and remedies thereunder, please visit Mini-Circuits' website at www.minicircuits.com/MCLStore/terms.jsp.