

## Baseband Transmitters and Receivers

This lecture covers the electrical aspects of the physical layer of baseband communication systems.

After this lecture you should be able to: explain two advantages of current loop signalling; define, calculate and explain the purpose for slew-rate limiting; specify source and load impedances that avoid reflections; distinguish between passive and active terminations; compute noise margins; select and design the most appropriate bus driver technology for a bus with multiple drivers; list some functions of line drivers and receivers; justify a choice between polled and contention-based buses; explain how transformers can be used to: interface between balanced and unbalanced transmission lines, separate common-mode and differential signals, provide protection from DC or low-frequency AC; calculate transformer turns ratios for a given impedance or voltage ratio; explain the purpose for, and design an optoisolator circuit.

### Current Loops

Data can be transmitted by using different currents rather than different voltages.

Current signalling uses a current source at the transmitter instead of a voltage source. The current swing stays constant regardless of the resistance of the line. The voltage across the terminating resistor at the receiving end always has the same voltage swing regardless of the length of the cable. The current loop's noise margin is thus independent of the length (resistance) of the circuit.

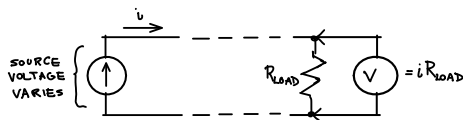

The use of current loops also makes it possible for the transmitter to determine when the loop has failed because it becomes an open circuit and the current stops flowing.

### Slew Rate

Slew rate is the rate at which a voltage changes as it switches between levels. It is typically specified in units of  $V/\mu s$ .

Limiting the slew rate makes transitions between voltage levels more gradual. Since the transmission line has capacitance that must be charged up, by reducing the slew rate we reduce the current that must be supplied to the transmission line.

**Exercise 1:** What is the current flowing into a 1nF capacitor if it is being charged at a rate of  $10V/\mu s$ ?

Reduced current flow also reduces the high-frequency components that are more likely to radiate from transmission lines and cause interference to other devices.

However, limiting the slew rate also limits the data rate because of the time it takes the signal to transition between voltage levels. Ideally, the slew rate is matched to the data rate so that the transition between voltage levels is a small fraction of the symbol duration.

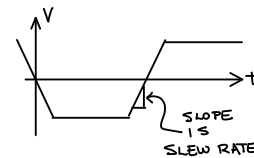

**Exercise 2:** The RS-232 standard specifies a maximum slew rate of  $30V/\mu s$ . Assuming a voltage swing of 30 volts, what is the maximum data rate for which two signal level transitions occupy 10% of the bit period?

### Impedance Matching and Terminations

The source (transmitter) and load (receiver) impedances should be the complex conjugate of the transmission line characteristic impedance to avoid reflections. Typically the characteristic impedance is resistive (real).

Often the receiver has a high impedance and a resistor is used to provide the appropriate termination. Terminations (often called "bus terminations" for multi-drop or multi-conductor topologies) are used at the ends of transmission lines to prevent reflections that would cause inter-symbol interference.

Passive terminations are resistors of a resistance equal to the characteristic impedance of the transmission line.

Active terminations connect the terminating resistor(s) to a low-impedance voltage source. The voltage is chosen to minimize the average current.

## Noise Margin

Noise margin is the noise level required to cause an error. For example, a bipolar signal received with levels of  $\pm 1V$  would have a noise margin of  $1V$  because a noise voltage of  $1V$  (in the wrong direction) would cause an error.

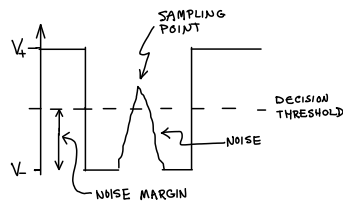

## Tri-State and Open-Collector Outputs

Bus-type network topologies consist of multiple devices connected in parallel to the same transmission line. There are two ways that bus drivers avoid having two outputs connected together.

The first method is to use open-collector (or open drain) outputs. The open-collector outputs can pull the line low but cannot source current or voltage. An external pull-up resistor sets the bus voltage high when none of the open-collector outputs are active. Open-collector outputs are simple to implement and provide all devices an indication that the bus is connected and active. However, the pull-up resistor results in constant power consumption and the RC time constant limits data rates.

**Exercise 3:** If the capacitance of the transmission line joining several OC drivers is  $1nF$  and the pull-up resistor is  $1k\Omega$ , how long will it take for the pull-up to pull the line from  $0V$  to 63% of the logic high voltage?

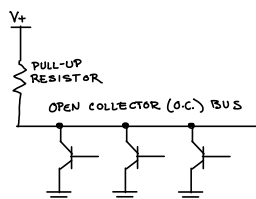

The second method is to use bus drivers with tri-state outputs. In addition to high- and low-voltage outputs, tri-state outputs also have a high-impedance output state that effectively disconnects the output from the bus. The design of a bus with tri-state drivers is more complex because some mechanism must be provided to switch each driver on and off at the appropriate times. This mechanism is usually part of a multiple-access protocol (e.g. CSMA or TDMA) that allocates the bus to different devices at different times

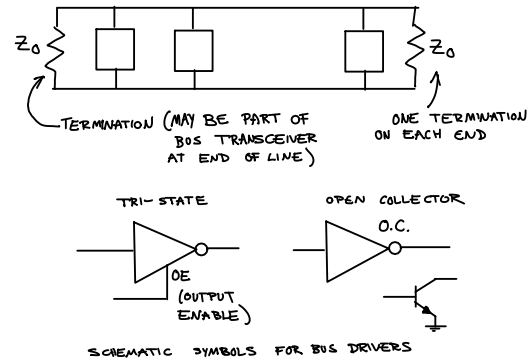

RS-485 is a standard similar to RS-422 that allows multiple drivers to be connected to a multi-drop bus. Only one device can have an active output at any given time – the others must be in a high-impedance mode.

## Bus Contention Protocols

One way to ensure that only one device at a time drives the bus is to select one device to act as the bus master. The other devices are called slaves. The master can then “poll” a slave to give it permission to drive the bus. This is typically done by sending a control message addressed to a specific slave.

**Exercise 4:** What are the consequences of increasing the delay between polls? What other factor might determine the maximum delay before slave gets access to the bus in a system using polling?

Although polling simplifies the design of slave-only devices, it can be wasteful of bus bandwidth and/or can result in long delays before a slave is able to transmit. Because of this, other bus arbitration techniques have been developed to allow different devices to contend (fight) for access to the channel. This is usually done by having devices detect the effect of a collision (when multiple devices try to drive the line at the same time).

For example, in the case of an open-collector output, the high (“recessive”) state is when the line is

high. If the bus is at the low (“dominant”) voltage but a specific device is not pulling the line low itself then this implies that some other device must be using the bus. Different protocols use this fact to handle contention in different ways.

Some contention-based bus arbitration protocols also implement the concept of priority. This enables some devices to obtain access to the bus ahead of others when more than one device wants to access the bus at the same time. This is important in real-time systems where it is necessary to guarantee a maximum delay for transmission of a message between devices.

**Exercise 5:** Consider a communication bus in a car that connects an airbag activation controller with a collision detector, a passenger-seat occupancy sensor and an airbag-disabling switch. Would it be more appropriate to use a polling- or contention-based bus arbitration protocol? Would it be appropriate for the arbitration protocol to allow different priorities for bus access? If so, what priorities might be assigned the different sensors?

Many (dozens of) bus contention mechanisms have been developed that provide different tradeoffs between complexity and performance. We will not study these in detail.

---

## Line Drivers and Receivers

---

Line drivers and receivers are ICs that interface digital logic circuits to transmission lines. The primary functions of these ICs are:

- convert to/from the voltage or current levels on the transmission line to logic-level signals (TTL, CMOS, etc).
- match the impedance of the transmission line to minimize reflections and maximize power transfer
- limit slew rate to limit interference to other devices
- provide protection from accidental short-circuits and overvoltage or overcurrent conditions
- provide switchable tri-state outputs or open-collector outputs if used on bus-type connections
- detect invalid voltage/current levels or disconnected lines when possible
- detect disconnected or floating transmission lines
- convert unbalanced logic level signals to/from balanced transmission lines (if appropriate)

We will study a typical line driver and receiver in the lab.

---

## Transformers

---

Transformers are widely used in baseband communications systems for various reasons.

Transformers can convert between balanced and unbalanced circuits. In this configuration the transformer is called a “balun”. If the balanced side of the transformer has a center-tap then this tap will be at the common-mode voltage. The common-mode circuit can be grounded, used to carry power (as in “power over ethernet”) or as a secondary (typically low-speed) signaling circuit.

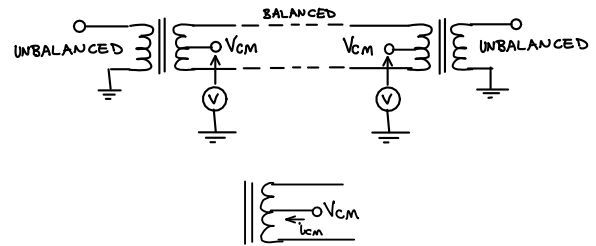

**Exercise 6:** If the common-mode circuit is used to carry 500mA, how much current flows through each half of the transformer secondary? What is the net effect on the flux in the transformer core?

Transformers can also convert impedances. The impedance ratio is the square of the turns ratio while the current ratio is the same as the turns ratio.

Transformers also protect logic circuits against high DC (or low frequency AC) voltages that might be accidentally applied to the transmission line. Each transformer will have a rated maximum isolation between primary and secondary. Typically this is on the order of 1kV or more. The term used for the transformers used for data interfaces such as 100BT Ethernet is “magnetics”.

The main disadvantages of transformers are that (1) they do not pass low frequency or DC signals and that (2) their cost and size remains relatively high because they cannot be integrated into ICs.

---

## Optoisolators

---

Optoisolators provide a way of isolating two circuits by coupling via light transmission.

An optoisolator (or optocoupler) consists of an LED and a photodiode in the same package. The input of the optoisolator is the LED. The LED generates

light when current flows through it. The light from the LED shines on a photodiode or phototransistor. The photodiode conducts when light from the LED strikes it. The photodiode is connected to the output circuit.

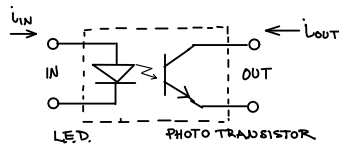

Since the connection between the LED and photodiode is by light alone, the input and output can be completely isolated electrically. The two sides do not even have to share a ground connection.

Although optocouplers can provide good isolation and are inexpensive, they have the disadvantage that they cannot supply power to the output. For many applications this makes an optocoupler interface more complex than one using a transformer.

**Exercise 7:** When the input to the optocoupler is high, will the output be high or low? Assume a pull-up is connected to the output.